

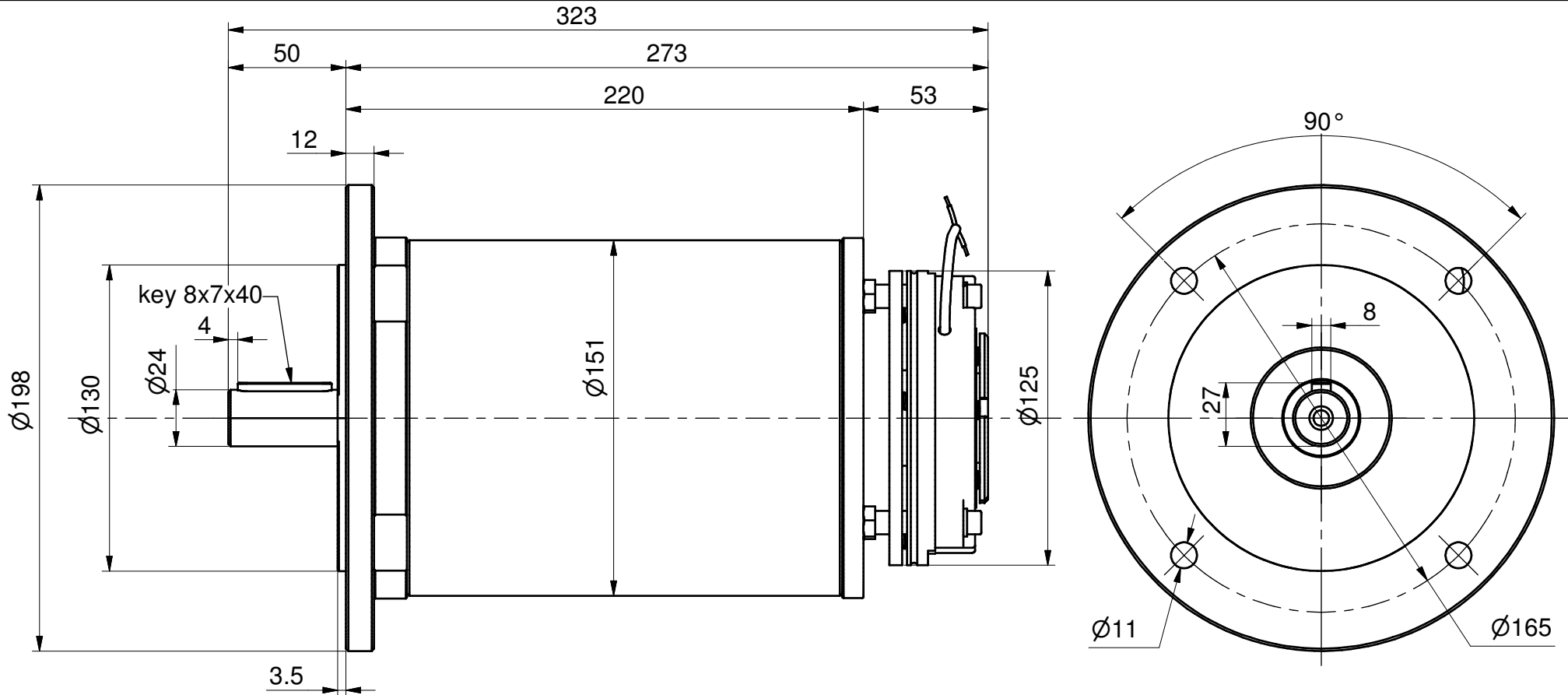

A.C. MOTOR

Code:
B5-BN90



DATI TECNICI - SPECIFICATIONS

MOTORE ASINCRONO D.151 B5-BN90
A.C. MOTOR D.151 B5-BN90

Eccitazione:
Excitation:

Coppia freno elettromagnetico
Electromagnetic brake torque

20 Nm

Optionals:

Peso
Weight