

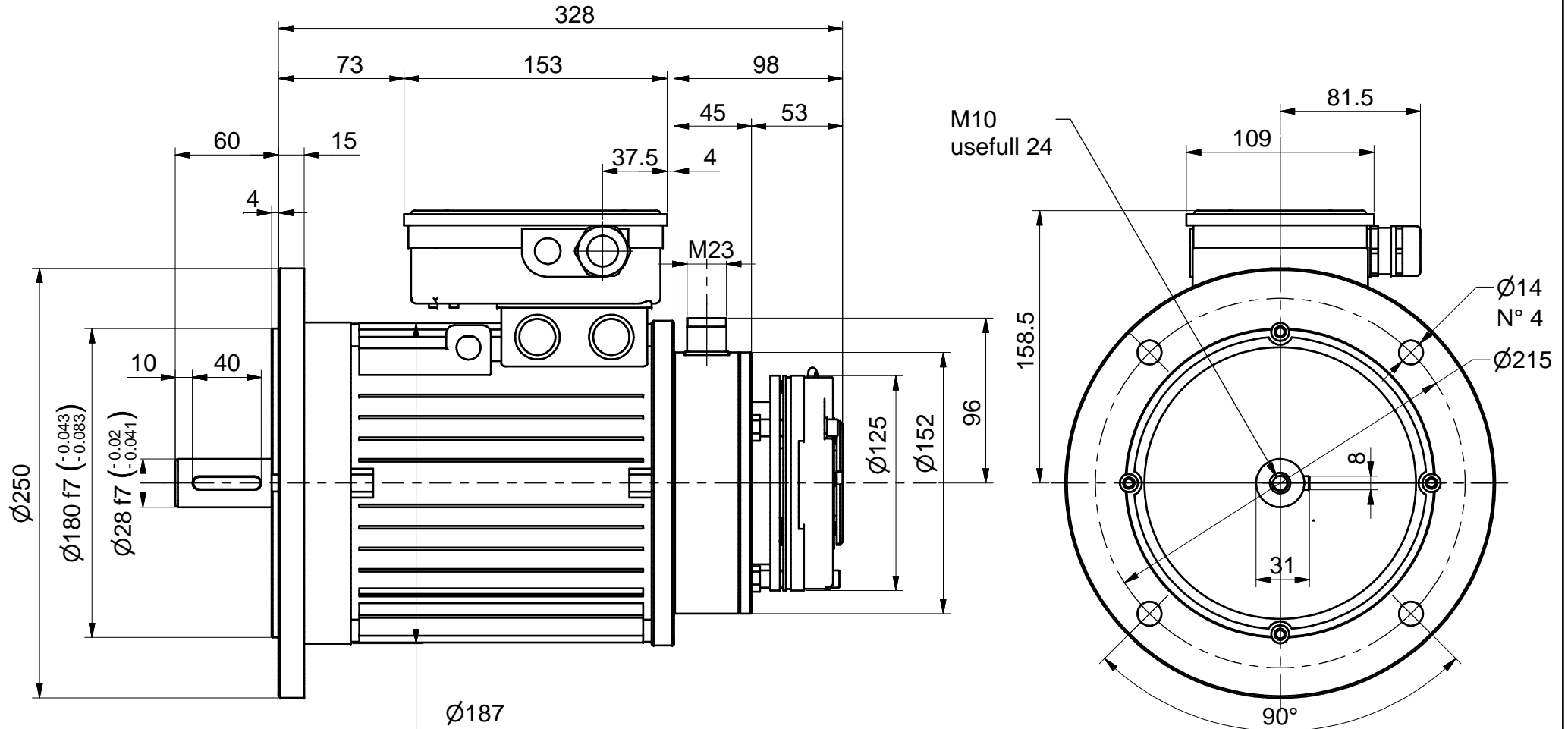

PMS BRUSHLESS MOTOR

Type:
B5-BN100



Electromagnetic brake torque
Coppia freno elettromagnetico

20Nm

Optionals:

Weight
Peso