

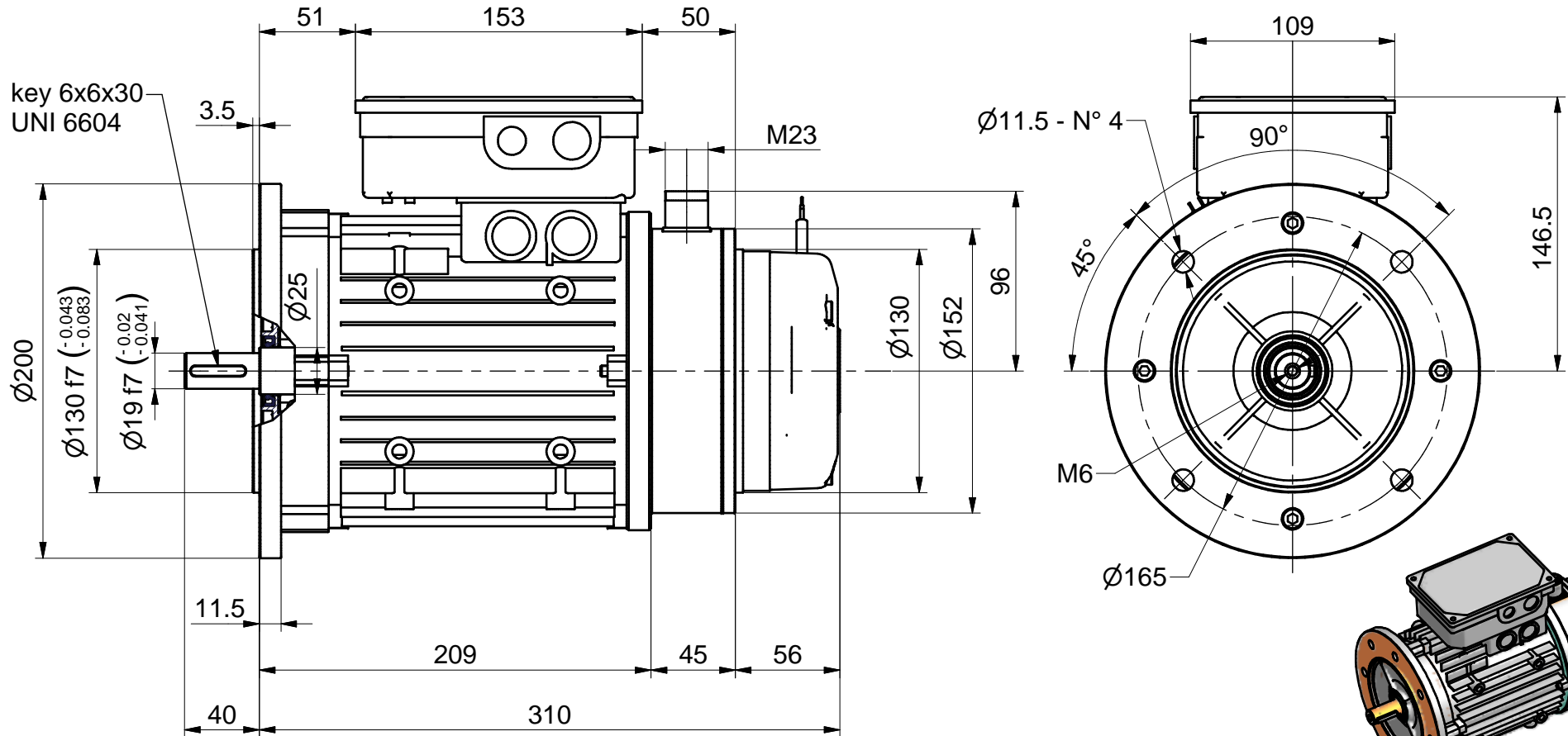

# BL MOTOR

Code:

**B5-BN80**



## TECHNICAL DATA

**BRUSHLESS MOTOR B5-BN80 - 6P resolver , M23 connector - WITH BRAKE**