

Kollmorgen Motion Control and Drive Solutions



AKM™ Servo Motors



AKM™ Washdown/
Washdown Food Servo Motors



AKMH™ Hygienic Stainless
Steel Servo Motors



ERD Hygienic Stainless
Steel Linear Actuators

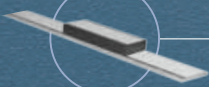

ICH Direct Drive Linear Motors



Cartridge DDR™
Direct Drive Rotary Motors



KBM™
Frameless Direct Drive Motors



AKD-N™ Decentralized Servo Drive



AKD® Servo Drives



AKI Touch Panels



AKD® PDMM
Motion Controller,
PLC and Servo Drive



Kollmorgen
Automation Suite (KAS)



KSM Safety Module

KOLLMORGEN®

Because Motion Matters™

Kollmorgen.

Every solution comes from a real understanding of the challenges facing machine designers and users.

The steadily growing demands of the marketplace are leading to ever-increasing pressures. Time constraints. Demands for better performance. Having to think about the next-generation machine even before the current one is built. While expectations are enormous, budgets are not. Kollmorgen's innovative automation and drive solutions and broad range of quality products help design engineers not only overcome these challenges but also build truly differentiated machines. Because it all comes down to the drive!

A powerful drive can distinctly differentiate a machine and deliver a marketplace advantage through increased productivity and performance. This translates to overall increased efficiency on the factory floor. A perfectly configured drive can make your customer's machine more reliable and efficient, enhance accuracy and improve operator safety. Drive technology also represents endless possibilities for innovation. We have always understood this potential, and thus, have kept drive technology at our core, relentlessly developing products that offer precision control of speed, accuracy, and positions that rely on complex motion.

Kollmorgen – your ticket to better drives

At Kollmorgen, we know that design engineers can achieve a lot more when there are no obstacles in the way. We provide design engineers with ideal conditions:

Integrating Standard and Custom Products

Standard products do not always offer the best solution. Our extensive application expertise allows us to modify standard products or develop totally custom solutions across our whole product portfolio so that no limits are placed on innovative design.

Drive Solutions Instead of Components

Many manufacturers are reducing their supplier base and cutting their construction staff. They require a provider of entire systems who offers a broad range of integrated solutions. Kollmorgen provides comprehensive solutions that combine programming software, engineering services, and best-in-class automation and drive components.

Global Footprint

Kollmorgen boasts production facilities and dealers in North America, Europe, the Middle East, and Asia, and offers design engineers and users of machinery a direct sales and support network spanning the globe. Our proximity helps speed delivery and lend support where and when they're needed.

Financial and Operational Stability

Kollmorgen is part of the Danaher Corporation, with an annual turnover of 13 billion USD. A key driver in the growth of all company divisions is the Danaher Business System, which relies on the principle of "kaizen" – or continuous improvement. With interdisciplinary teams made up of highly skilled employees and world-class tools, we optimize our processes and develop plans that result in superior performance.

Table of Contents

Kollmorgen Automation Suite	1
▶ PLC software and drive programming	5
▶ AKD PDMM servo drive / PLC / motion controller	9
▶ AKI HMI touch panels	10
▶ AKT I/O bus terminals	11
Servo Drives	13
▶ AKD	17
▶ AKD Basic	19
▶ AKD PDMM	21
▶ AKD-N	29
▶ S700	35
Safe Motion Safety Controllers	41
▶ Kollmorgen Motion Safety concept	43
▶ KSM compact, KSM modular	46
Servo Motors	47
▶ AKM universal precision servo motors	49
▶ AKM Washdown and Washdown Food	51
▶ AKMH hygienic stainless steel servo motors	59
▶ ERD hygienic stainless steel linear actuators	69
▶ VLM economic servo motors	73
Linear Direct Drives	77
▶ ICH linear motors	79
Rotary Direct Drives	85
▶ Cartridge DDR	87
▶ KBM frameless direct drives	91
▶ Direct drive technology	99
Accessories	101
▶ KCM-S dynamic braking energy storage	101
▶ KCM-P static energy storage	101
▶ Cables, clamps, regen resistors, chokes	102
Model Nomenclature	103
▶ Model Nomenclature	

Kollmorgen Automation Suite™

Get to market faster while reducing costs with innovative drive solutions! The Kollmorgen Automation Suite supports you with harmonized software and hardware components. Whether it is a simple single-axis drive or a complex multi-axis drive system: With the Kollmorgen Automation Suite you quickly achieve comprehensive machine automation solutions.

The Kollmorgen Automation Suite is based on three pillars – the integrated development environment, the hardware (such as multi-axis controllers, interface and safety modules), and a broad portfolio of servo motors, as well as engineering support from Kollmorgen in the development of special drive solutions. The integrated development environment offers all the tools for PLC and drive programming, for the user interface display, and extensive offline test and debugging tools. All drive components communicate with each other via the fast EtherCAT system bus, and fieldbus protocols are available for connecting to higher-level systems. With Kollmorgen's wide range of servo motors – be they rotary or linear – you'll see incredible motion.

Do not make compromises when designing your drive and give us a call! There have been thousands of occasions where customer-specific modifications of existing products or new developments have turned a drive into the perfect drive. The Kollmorgen engineering team is highly capable of turning the seemingly impossible into reality.

The Advantages of Kollmorgen Automation Suite

- | | |
|--|--|
| <ul style="list-style-type: none"> • High machine performance | <ul style="list-style-type: none"> • Up to 25% greater throughput • Up to 50% scrap reduction • Improved accuracy • Advanced drive technology for machines with outstanding performance |
| <ul style="list-style-type: none"> • Fast to market | <ul style="list-style-type: none"> • Up to 30% reduction in development time • Services available for program development, training, start-up, and support • Industry standard programming environment and industrial networks |
| <ul style="list-style-type: none"> • Enhanced ease-of-use and integration | <ul style="list-style-type: none"> • Single integrated programming environment for automation, drive technology, and all hardware • Drag-and-drop motion programming • Certified components that are tested to work together • Seamless integration and configuration of amplifiers for optimal set-up |
| <ul style="list-style-type: none"> • A demonstrated solution | <ul style="list-style-type: none"> • The result of over 20 years of permanent optimization of programming and implementing automation and drive solutions • Provides the diverse experience of a great number of suppliers and platforms that form today's Kollmorgen • Used successfully for more than 6 years |

Kollmorgen Automation Suite

Integrated Software and Hardware System for Efficient Drive Design

Using the components of the Kollmorgen Automation Suite, you develop better drives in less time. The comprehensive control system solution comprises all the components for system design, programming, display, testing, and start-up. In terms of hardware, the AKD PDMM – the 3-in-1 solution with integrated servo drive, motion controller, and PLC – is the central component in the machine.

KOLLMORGEN AUTOMATION SUITE

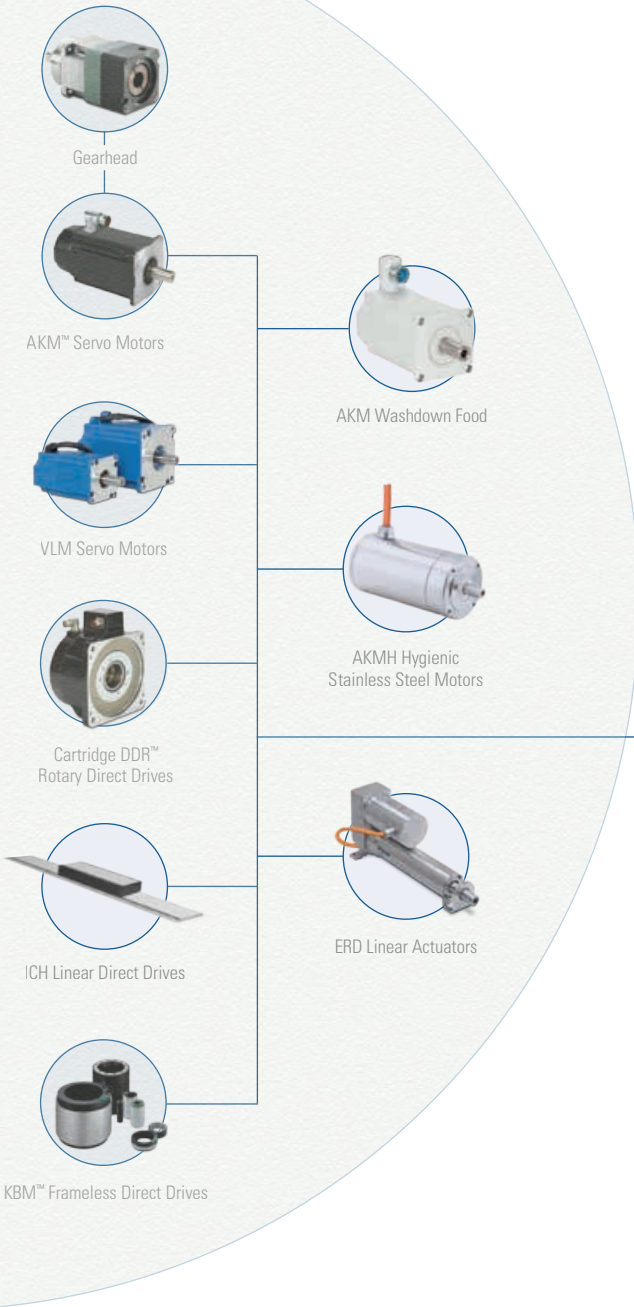

System programming with the Pipe-Network™ or PLCopen



AKI touch panels operate and display



Control of motors with AKD® PDMM programmable multi-axis master

Interface diversity: I/O bus terminals AKT - Advanced Kollmorgen Terminals

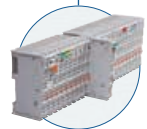

Diverse and Scalable Drive Solutions

Need more axes? Different motor outputs? Linear direct drives here, direct drives with no housing there? No problem! With the EtherCAT system bus you can connect more AKD servo drives and add motors of all performance classes from the Kollmorgen product range.

Interfaces are frequently the bottleneck in system design. Not so with the Kollmorgen Automation Suite. With the AKT (Advanced Kollmorgen Terminals) IO bus terminals and the EtherCAT bus coupler, you possess a flexible interface system which leaves nothing to be desired.

Control and monitor the processes on the machine with the AKI series touch panels. With the KVB (Kollmorgen Visualization Builder), you can program ergonomic user interfaces which guarantee safe handling and which display machine data clearly.

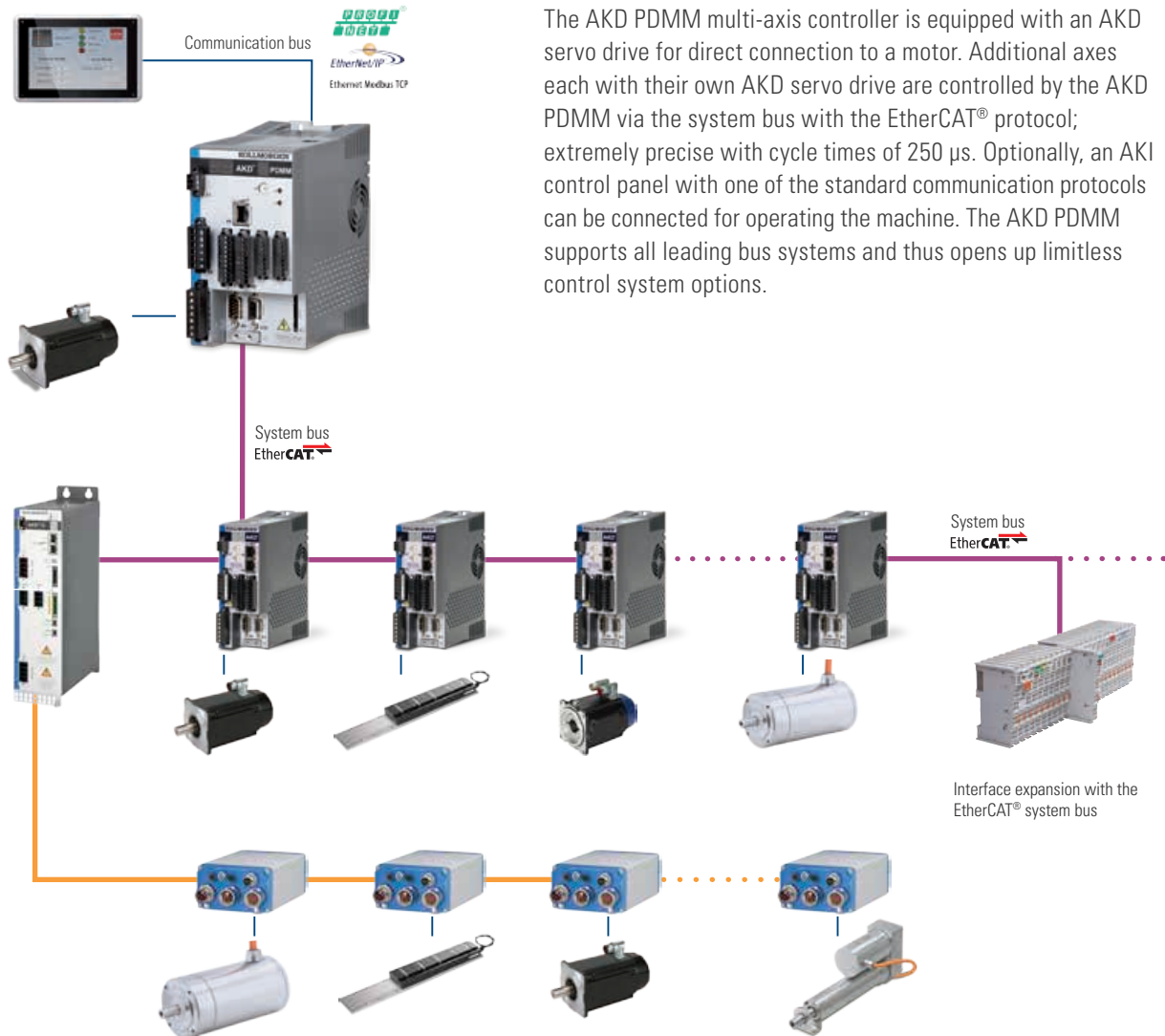

The AKD PDMM multi-axis controller is equipped with an AKD servo drive for direct connection to a motor. Additional axes each with their own AKD servo drive are controlled by the AKD PDMM via the system bus with the EtherCAT® protocol; extremely precise with cycle times of 250 μ s. Optionally, an AKI control panel with one of the standard communication protocols can be connected for operating the machine. The AKD PDMM supports all leading bus systems and thus opens up limitless control system options.

Flexible single or multi-axis drive solutions in decentralized and central architectures with AKD-PDMM and the Kollmorgen Automation Suite

Software PLC

User-friendly, Self-explanatory, Self-detecting

- Kollmorgen Automation Suite offers an integrated set of tools that allow programmers of automation systems to create high-quality software. This includes not only our drive control solution, but also the IEC 61131-3 toolkit for PLC programming.
- The environment for developing PLC programs has been created to help design engineers develop solutions faster. It enables the detection and configuration of drive control components to accelerate system development. With auto-recognize and auto-configure features, testing efforts are reduced.
- Once an application or a function block has been created for an application, the user can save this as a "user-defined function block" to make it easier to reuse the tested software in subsequent projects and thus to save time.
- Maintain your standards in corporate programming languages by using any of the IEC 61131-3 languages. Or even improve them by mixing and matching several languages to develop the best solution for your application.
- Kollmorgen Automation Suite's integrated development environment allows the developer to create solutions without having to connect a single device by using the offline simulator. This lets you start creating systems before the first hardware component is delivered. Simply configure your system network in "offline development mode" and change the status of the devices when you actually connect them.
- Standard debugging functions – such as "step into" and "step over" – are available to troubleshoot programs. In addition, debugging support is available in the form of a software oscilloscope into which multiple variables can be entered. The display of the oscilloscope can also be configured for the desired scale.
- Our excellent CAM Editor allows you to create complex CAM profiles with a "graphical" interface. It is also possible to import existing CAM profile points directly into the CAM Editor, which allows you to seamlessly continue using your existing know-how in machine manufacturing.

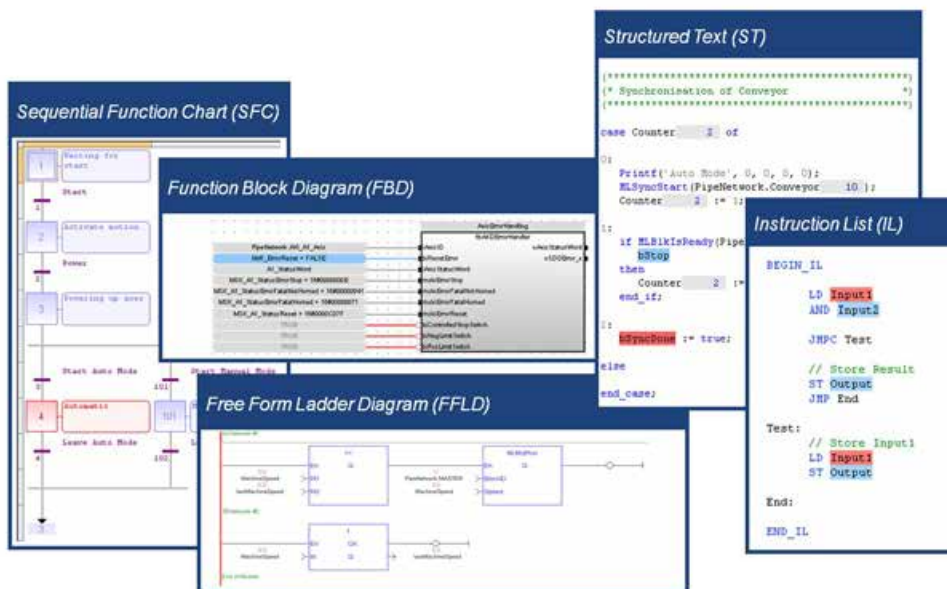

All five IEC 61131-3-PLC languages are supported

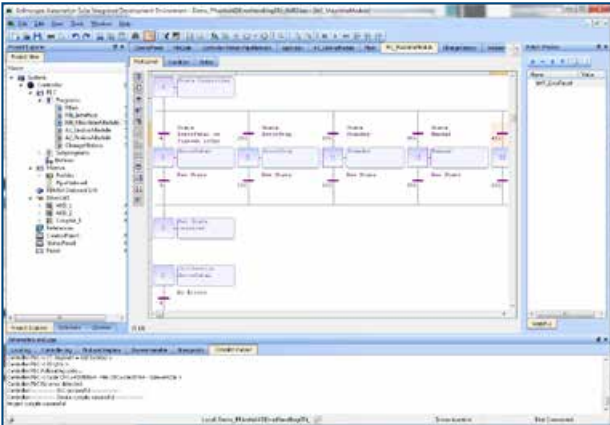

Customizable environment for docking/undocking and floating panels on the screen
 Watch window to closely monitor special variables
 Filter information and log messages to focus on the essentials
 Opportunity to adjust the development environment and control parameters across the entire development environment

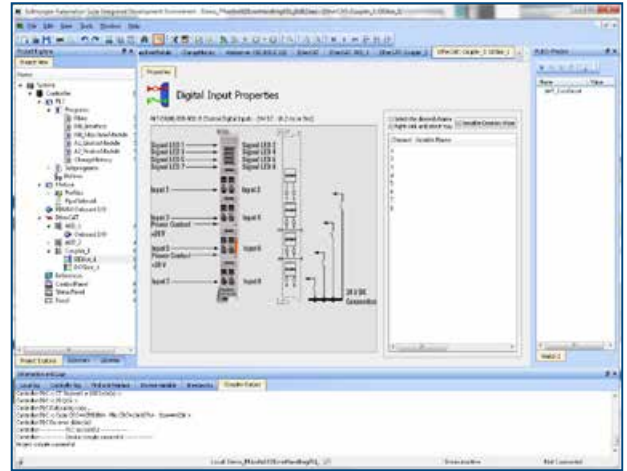

Automatic I/O variable creation in the appropriate area of application with oscilloscope definitions
 Adding bus couplers with I/Os into a drive network topology

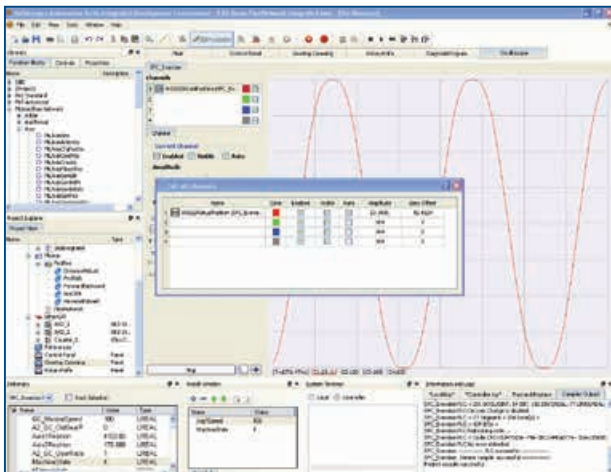

Integrated software oscilloscope

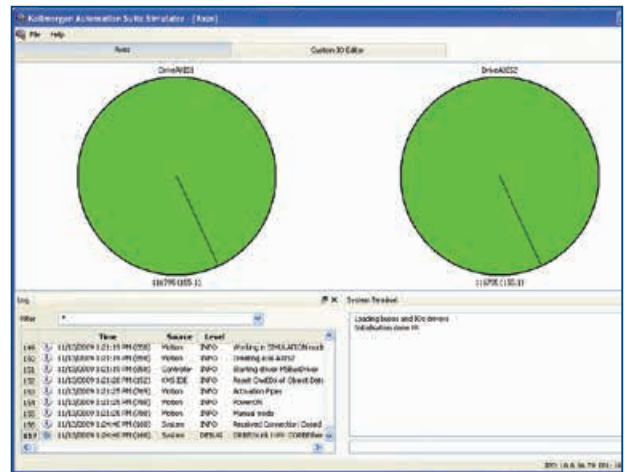

Simulator for PLC and motion control

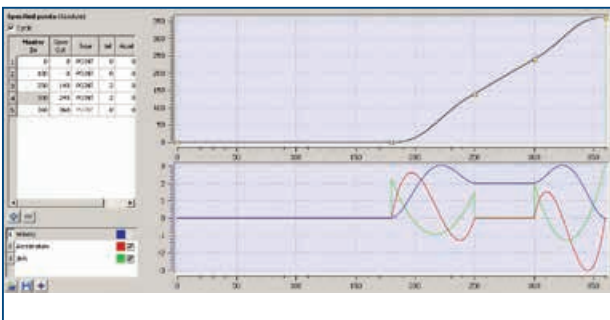

Graphical environment for creating CAMs

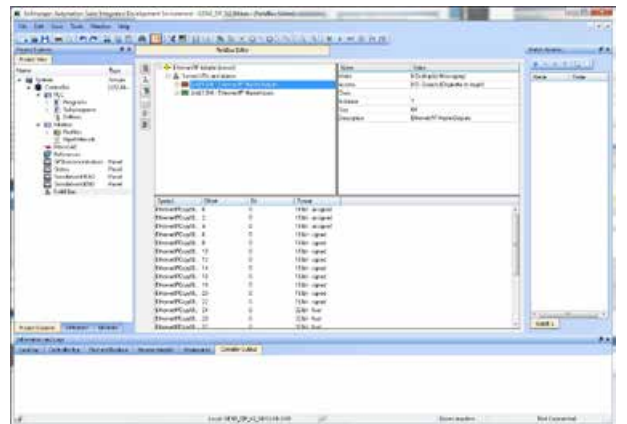

Integrated fieldbus configurator ProfiNet, EtherNet/IP, and Modbus TCP

Drive Programming

PLCopen and Pipe Network™

You can see to the drive programming with the industry standard PLCopen or with the graphical interface of the Kollmorgen Pipe Network. PLCopen comprises a multitude of platform-independent function blocks for single-axis, synchronous, and interpolating motion tasks. Even without detailed system-specific knowledge, complex, standardized motion functions are available to you at the click of a mouse, so that you are able to concentrate entirely the ideal configuration of machine functionality.

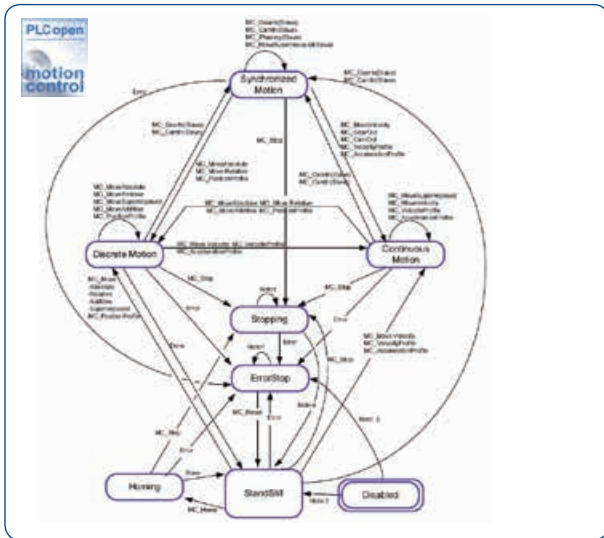

PLCopen State Diagram

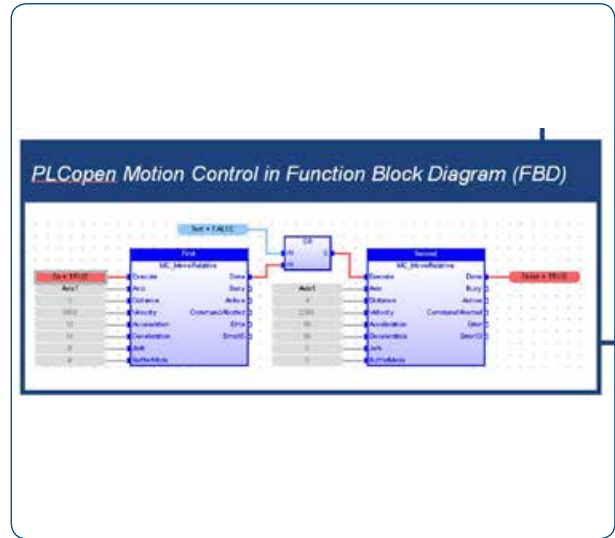

PLCopen example

Graphical Programming Using the Pipe Network

With the Pipe Network's graphical programming interface, Kollmorgen also simplifies the drive programming. The mechanical elements of the drive are simulated by logical blocks which are connected to one another using drag-and-drop. The entire mechanical system is thus illustrated by logical blocks. The graphical depiction clarifies the architecture and the relationships between the different axes of a system, while the improved the system topology documentation simplifies maintenance.

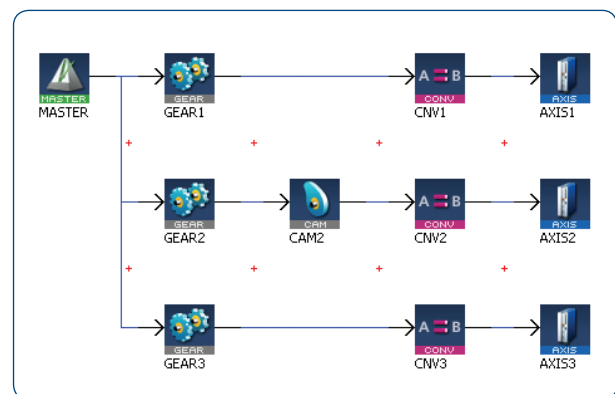
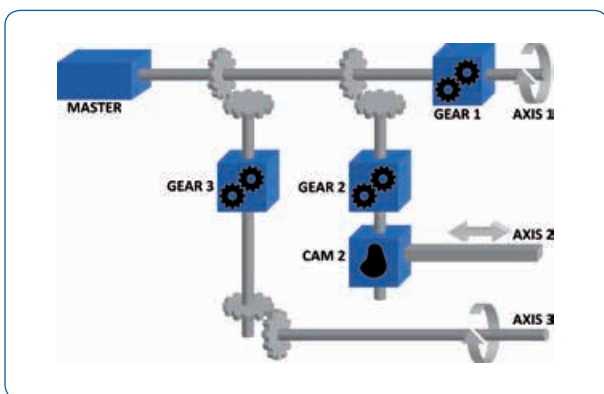

The Pipe Network displays the mechanical elements of the drive in the form of logical function blocks that are positioned using drag-and-drop.

HMI Programming

Kollmorgen Visualization Builder™ (KVB)

The Kollmorgen Visualization Builder operates from within the Kollmorgen Automation Suite integrated development environment making it quick and easy to create your HMI programming and transfer it to the Kollmorgen AKI HMI panels.

- Selection of application variables (tags) to be used by the Kollmorgen Visualization Builder; a file is automatically created.
- Automatic import of the selected application variables (tags) in your HMI project

Features include:

- Multi-screen navigation
- Trend creation
- Recipes
- Alarm management
- Internal variables
- Multiple text – Control system change based on input value
- Function keys
- Security

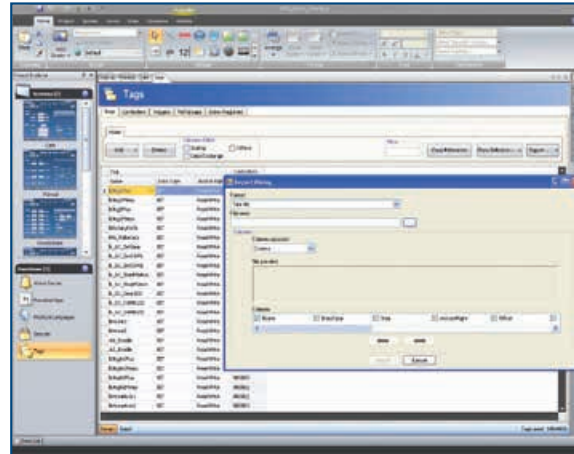

HMI developer environment

Real-time Motion Bus

EtherCAT® Real-time Bus for Drive and I/O Connectivity

- Real-time Ethernet-based motion bus
- Widely accepted open standard
- Standard Ethernet cabling = lower implementation costs
- High bandwidth utilization for high performance
- Interoperability with other bus systems
- Wide availability of devices
- Auto-recognition of components compatible with Kollmorgen Automation Suite
- Integrated EtherCAT configurator for incorporating 3rd-party EtherCAT slaves and support from MDP (Multiple Device Profile)

EtherCAT® 

AKD[®] PDMM

Motion Controller, PLC, and Servo Drive in One Device

As a central, multi-axis controller, the AKD PDMM is perfectly suited for controlling single and multi-axis drives with increased demands. Supplied in two performance categories, the AKD PDMM (Programmable Drive Multi Master) controls 10 or more axes* at 1-ms cycle time in the 800 MHz version, 20 axes or more* in the 1.2-GHz version, and also offers PLC functionality without an additional motion controller. You therefore save up to 30% on space in your switch cabinet, reduce wiring complexity, and lower machine costs. The Kollmorgen Automation Suite (KAS) development environment assists you with programming and reduces development times considerably – irrespective of whether it is a single-axis drive or a drive system with 50 axes.

* With increased cycle time

Features

- Two performance categories for 10 axes or 20 axes with 1-ms cycle time
- Real-time-capable control with EtherCAT Master integrated in an AKD servo drive
- Plug-and-play-compatible with all Kollmorgen motors
- Supports Kollmorgen's single-cable solutions
- 128 kB of non-volatile memory for the secure storage of important machine and process data
- SD card slot for backing up and restoring application software, firmware, and control parameters without a PC
- Local digital and analog inputs and outputs: 13 digital inputs, 4 digital outputs, an analog input, an analog output (expandable using AKT series EtherCAT bus terminals)
- Direct connection of the operating device through the integrated Kollmorgen Visualization Builder (KVB) HMI software and full support of the Kollmorgen AKI series operating devices
- A central connection for the PLC, HMI, motion control, servo drive, and CAM Designer
- Shorter start-up times due to error detection using simulation during application development
- Simple integration into available automation architectures with integrated Ethernet/IP, ProfiNet, or ModbusTCP interfaces
- Integrated web server for maintenance work, no software installation required



Technical Data

120/240 V AC 1 and 3-phase	Continuous current (A _{eff})	Peak current (A _{eff})	H (mm)	W (mm)	D (mm)
AKD-M00306-Mx*EC-D000	3	9	168	89	156
AKD-M00606-Mx*EC-D000	6	18	168	89	156
AKD-M01206-Mx*EC-D000	12	30	196	96	187
240/400/480 V AC 3-phase	Continuous current (A _{eff})	Peak current (A _{eff})	H (mm)	W (mm)	D (mm)
AKD-M00307-Mx*EC-D000	3	9	256	100	185
AKD-M00607-Mx*EC-D000	6	18	256	100	185
AKD-M01207-Mx*EC-D000	12	30	256	100	185
AKD-M02407-Mx*EC-D000	24	48	306	105	228

* x=C: 0.8-GHz version, x=1: 1.2-GHz version

AKI User Interface (HMI)

Operating Machines and Displaying Processes

With the robust AKI touch panels, you are equipping your machine with an ergonomically designed user interface. You develop the design of the display graphics and the control system functionality with the Kollmorgen Visualization Builder, which forms part of the Kollmorgen Automation Suite.



Performance Data

		AKI-CDA-MOD-			AKI-CDB-MOD-			AKI-CDC-MOD-		
		04T	07T	10T	07T	12T	16T	12T	15T	21T
Hardware										
Display, backlight		TFT-LCD, LED			TFT-LCD, LED			TFT-LCD, LED		
Display, color depth		480 x 272 16.7 m	800 x 480 262k	640 x 480 16.7 m	800 x 480, 262k	1280 x 800 262k	1280 x 800 262k	1280 x 800 16 m	1280 x 800 16 m	1920 x 1080 16 m
Screen size, active display W x H		inch 4.3 inches mm 95.0 x 53.9	7 inches 152.4 x 91.4	10.4 inches 211.2 x 158.4	7 inches 152.4 x 91.4	12.1 inches 261.1 x 163.2	15.4 inches 331.2 x 207.0	12.1 inches 261.1 x 163.2	15.4 inches 331.2 x 207.0	21.5 inches 664 x 268
Front/rear seal		IP65/IP20			IP65/IP20			IP65/IP20		
Touchscreen material		Polyester on glass, resistive coating: Autotex EBA 180L			Polyester on glass, resistive Autotex EBA 180L		Autotex F157 or F207	Polyester on glass, resistive coating: Autotex F157 or F207		
Reverse side		Powder-coated aluminum			Powder-coated aluminum			Powder-coated aluminum		
Processor / RAM		ARM9, 400 MHz / 128 MB			Intel Atom, 1.1 GHz			Intel Core i		
Application memory (flash)		80 MB			1.4 GB or greater			8–64 GB		
HDD expansion		No			no			Yes		
Memory expansion		SD card			SD card			External memory via USB		
Real-time clock		Yes			Yes			Yes		
Power consumption at 24 V DC		3.6 W	6.0 W	9.6 W	14 W	22 W	24 W	107 W	114 W	125W
Fuse		Internal, 2.0 AT, 5 x 20 mm			Internal, 3.15 AT			Internal, 10 AT		
Power supply		+24 V DC (18–32 V) ¹⁾			+24 V DC (18–32 V) ¹⁾			+24 V DC (18–32 V), 140 W ¹⁾		
Fan		No			no			Yes		
Operating temperature		-10°C to +60°C			-10°C to +50°C			0°C to +50°C		
Storage temperature		-20°C to +70°C			-20°C to +70°C			-20°C to +70°C		
Relative operating humidity		< 85%, non-condensing			5% to 85%, non-condensing			< 85%, non-condensing		
Certifications, approvals										
CE approvals		Noise test EN61000-6-4 (emitted interference) and EN 61000-6-2 (interference immunity), AKI-CDC additional EMC directive 2004/108/EC								
UL-, cUL-approval ²⁾		UL 1310 class II			UL 508			UL 508		
Communication										
Serial port RS422/RS485		COM2, COM4, 9-pin D-sub contact, 4-40UNC screw connection								
Serial port RS232C		COM2, COM4, 9-in D-sub contact, 4-40UNC screw connection								
Ethernet		1 x 10/100 Mbit/s (shielded RJ45)			1 x 10/100/1000 Mbit/s, shielded RJ45			2 x 10/100/1000 Mbit/s, shielded RJ45		
USB		1 x USB Host 2.0, max. current 200 mA			3 x USB Host 2.0, max. current 500 mA			4 x USB Host 2.0, max. current 500 mA		
Fieldbus		1 x expansion module (option)								
Software/graphics										
Operating system		Windows CE6			Windows CE6			Windows 7 (standard or embedded)		
PDF viewer		No			Yes, basic functions			Yes		
Web browser		No			Yes, basic functions			Yes		
Vector graphics / shadows, transparency		No / No			No / No			Yes / Yes		
Dimensions										
Front panel, W x H x D		(mm) 145 x 103 x 7	204 x 143 x 7	280 x 228 x 7	204 x 143 x 50	340 x 242 x 57	410 x 286 x 61	340 x 242 x 79	410 x 286 x 83	556 x 347 x 87
Section		(mm) 128 x 87	189 x 128	262 x 209	189 x 128	324 x 226	394 x 270	324 x 226	394 x 270	539 x 331
Installation depth / depth with clearance		(mm) 43/143	43/143	44/144	43/143	50/150	54/154	72/172	76/176	79/179
Weight		0.5 kg	0.8 kg	1.5 kg	0.9 kg	2.5 kg	3.6 kg	4.2 kg	5.4 kg	8.1 kg

1) For CE: The power supply must meet the requirements of the IEC 60950 and IEC 61558-2-4 standards

For UL and cUL: The voltage supply must meet the requirements for class II power supplies

2) If product or packaging is labeled

AKT I/O Bus Terminals

Advanced Kollmorgen Terminals (AKT)

Kollmorgen Automation Suite includes an array of I/O options for applications that need more I/Os than required by the integrated I/Os of the amplifiers or require functionality such as the thermal element management via I/O. The IP20 connection terminals for the DIN rail mounting are simply pushed together and connected to the system's EtherCAT bus where they are auto-recognized for easy configuration.

Bus coupler	
AKT-ECT-000-000	EtherCAT Bus Coupler
Analog Inputs	
AKT-AN-410-000	4-channel analog input module, 0-10 VDC
AKT-AN-420-000	4-channel analog input module, 0-20 ma
AKT-AN-810-000	8-channel analog input module, 0-10 VDC
AKT-AN-820-000	8-channel analog input module, 0-20 ma
AKT-AN-200-000	2-channel thermocouple input module
AKT-AN-400-000	4-channel thermocouple input module
Analog outputs	
AKT-AT-220-000	2-channel analog output module, 0-20 ma
AKT-AT-410-000	4-channel analog output module, 0-10 VDC
AKT-AT-420-000	4-channel analog output module, 0-20 ma
AKT-AT-810-000	8-channel analog output module, 0-10 VDC
AKT-AT-820-000	8-channel analog output module, 0-20 ma
Digital outputs	
AKT-DT-004-000	4 Channel Digital Output Module, 0.5A
AKT-DT-008-000	8-channel digital output module, 0.5A
AKT-DT-2RT-000	2-channel relay output module, 2.0A, N/O
Digital inputs	
AKT-DN-004-000	4 Channel Digital Input Module, 3 ms
AKT-DNH-004-000	4 Channel Digital Input Module, .2 ms
AKT-DN-008-000	8-channel digital input module, 3 ms
AKT-DNH-008-000	8-channel digital input module, 2 ms
Special modules	
AKT-EM-000-000	End Module
AKT-IM-000-000	Isolation module
AKT-PS-024-000	Bus Feed Terminal, 24 Vdc
AKT-PSF-024-000	Bus Feed Terminal, 24 Vdc, Fused



I/O bus terminal system



EtherCAT bus coupler



I/O bus terminal modules
Front connections and side view

Services

Application Development, Start-up, Troubleshooting

The Kollmorgen Automation Suite portfolio offers the customer extensive support in application and solutions development. Some of the key areas in which we offer development services include:

- Development and on-site implementation in accordance with IEC 61131-3, Pipe Network, PLCopen, HMI, and drive control for standard drives and complex, synchronized drives across multiple axes
- Knowledge transfer to support you with system maintenance
- Helps keep personnel costs low in the initial phase of machine building
- Support with integrating your machine on the factory floor

Start-up and troubleshooting services are available to ensure the rapid commissioning of new systems and to resolve unexpected issues that may arise with a new or established installation.

In addition, Kollmorgen offers wide-ranging training in many areas related to motion control and automation. Training can be offered either on-site or off-site and with specialized demo kits to help the trainees obtain practical experience during the training program and allow them to directly use what they have learned. The training sessions can take place using a web training program online or in training rooms. In both cases, trainees can access a training kit with a programmable automation controller, AKD servo drives, I/Os, and AKM motors in a single compact unit.

Training is available for the IEC 61131-3 languages, PLC solution architecture, HMI solution development, and drive control. Custom training courses are offered to suit the specific needs of a given organization and can be put together on request.

AKD[®] Servo Drives

Our AKD series offers a complete range of Ethernet-based servo drives with a high degree of versatility, maximum flexibility, and a large range of functions that can be integrated quickly and easily into nearly any application. With plug-and-play capabilities, AKD enables quick and simple start-up with all your machine's components. The AKD series of servo drives are available with a wide range of communication options and in multiple performance categories to meet any requirements. They offer exceptional servo performance and stand out with their compact design.

When combined with our high-grade components, this robust, technologically advanced amplifier product range delivers optimized performance and higher-quality results at greater speeds and with more uptime. With Kollmorgen servo components you can increase your machine's overall efficiency by up to 50%.

The Advantages of AKD Servo Drives

-
- Higher machine speed/throughput
 - Feedback with maximum resolution (up to 27 bit)
 - Torque and speed control with high bandwidth – the quickest digital torque control on the market: 0.67 μ s
 - Multi-function Bode plot simplifies the evaluation and optimization of drive and machine performance
 - Patented, powerful autotuning algorithms
 - Enhanced servo technologies enable excellent machine performance
 - High-resolution analog input (digital --> analog)
-
- Less rejects, better quality
 - Two powerful processors enable quick rise times
-
- Quicker exchange, increased availability
 - "Real-time" software oscilloscope with six channels for quick start-up and diagnostics
 - Automatic completion of programmable commands saves searching for parameter names
 - The recording and transmission of program plots and parameter settings with a single mouse click enables the immediate transfer of machine performance data.
 - Powerful and user-friendly user interface
 - Robust and reliable quality
-
- Faster to market
 - Supports a large number of single-turn and multi-turn feedback systems – digital resolvers (SFD), EnDat2.2, EnDat2.1, BiSS, analog sin/cos encoders, incremental encoders, HIPERFACE® and resolvers
 - Integrated motion bus systems EtherCAT®, SynqNet®, PROFINET®, Ethernet/IP® and CANopen®
 - For operating rotary and linear motors
 - Wide range of programming options
 - Compatible with many front end controllers
 - Exceptional power density

Scalable Programming

The AKD servo drive delivers innovative technology and performance in extremely compact dimensions. The AKD is flexible enough for all areas of application. Whether it's just a single axis - such as an analog control for speed and torque - or 128 axes with a fully programmable, synchronized drive: AKD is the answer.

The Advantages for You

- Optimized performance
- Higher throughput and improved precision
- User-friendly graphical user interface (GUI) for quicker start-ups and troubleshooting
- Flexibility and scalability for every area of application



AKD with drive functions (AKD-P)

- Simple indexing using 'Point and Click'
- Preprogrammed options
- Guides inexperienced users through simplified steps to create indexing motions
- 11 digital I/O and 2 analog I/O
- 2 high-speed digital inputs

More information on page 23

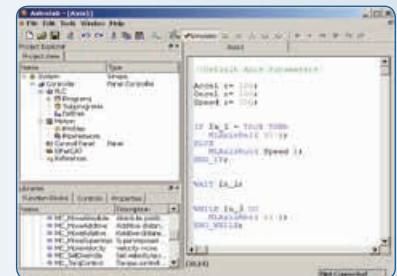

AKD BASIC Programmable 1.5-axis drive (AKD- T)

- Expansion of the basis AKD to a simplified programming language similar to Basic
- Conditional instructions, mathematical functions, user functions, and sub-routines
- Access to 11 digital I/O and 2 analog I/O, expandable to 31 digital I/O and 4 analog I/O
- 2 high-speed digital inputs

More information on page 19

Basic Operation

Programming

KOLLMORGEN AUTOMATION SUITE FUNCTION BANDWIDTHS

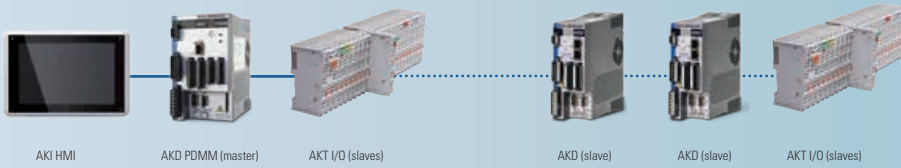

AKD PDMM as an independent single-axis drive with integrated motion control and soft PLC (AKD-M)

- Offers all the options of the Kollmorgen Automation Suite – a complete, scalable programming environment
- Supports all five IEC 61131-3 languages (structured text, function block diagram, ladder diagram, instruction list, sequential function chart) for process programming (soft PLC)
- Drive programming with PLCopen or the innovative Kollmorgen Pipe Network™
- With function blocks such as "wait" the program behaves like a scanning or sequential language
- 17 digital I/O (of which 2 are high-speed inputs) and 2 analog I/O
- Control of the AKT™ Additional I/O enables almost unlimited expansion

More information on page 21

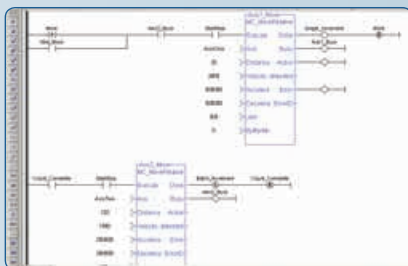

Seamless integration of additional axes enhances the AKD PDMM to become a powerful, multi-axis machine control system

- Synchronized contour control of up to 8 axes
- Reduced spatial requirements and simpler connection through motion and machine control in a single housing
- Simple management of the remote I/O and the I/O of all connected drive controllers using EtherCAT
- PLCopen for the programming of motions and Pipe Network™ – programming of mature applications for cams and gearheads within minutes
- Each additional AKD expands the system by 11 digital I/O, 2 analog I/O, and 2 digital high-speed inputs

More information on page 21

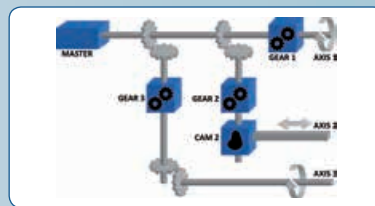

IEC 61131-3 with five languages for process programming (soft PLC)

Select between PLCopen and the Pipe Network from Kollmorgen for the programming of drive tasks

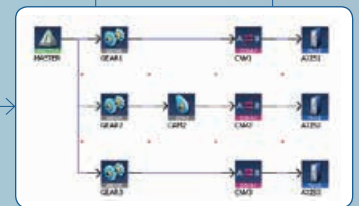

The Pipe Network visualizes a mechanical system in the form of function blocks

for One Axis

Programming for Several Axes

AKD Servo Drives

Intelligent Control for all Kollmorgen Motors

The AKD servo drive combines innovative technology and outstanding performance in extremely compact dimensions. These feature-rich servo drives provide solutions for nearly any application: from basic torque and speed control, to register control, through to fully programmable multi-axis applications with embedded Kollmorgen Automation Suite. The universal AKDs set the standards for power density and efficiency.



Gearhead



AKM™ Servo Motors



VLM Servo Motors



Cartridge DDR™
Rotary Direct Drives

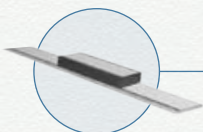

ICH Linear Direct Drives



KBM™ Framless Direct Drives



AKM Washdown Food



AKMH™ Hygienic
Stainless Steel Motors

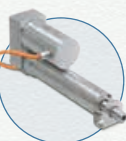

ERD Linear Actuators



Power Range

Combined with the Kollmorgen motors, the AKD servo drives offer optimized performance. From 3 to 48 Aeff continuous current and 9 to 96 Aeff peak current, the feature-rich AKD servo drives provide solutions for nearly any application.

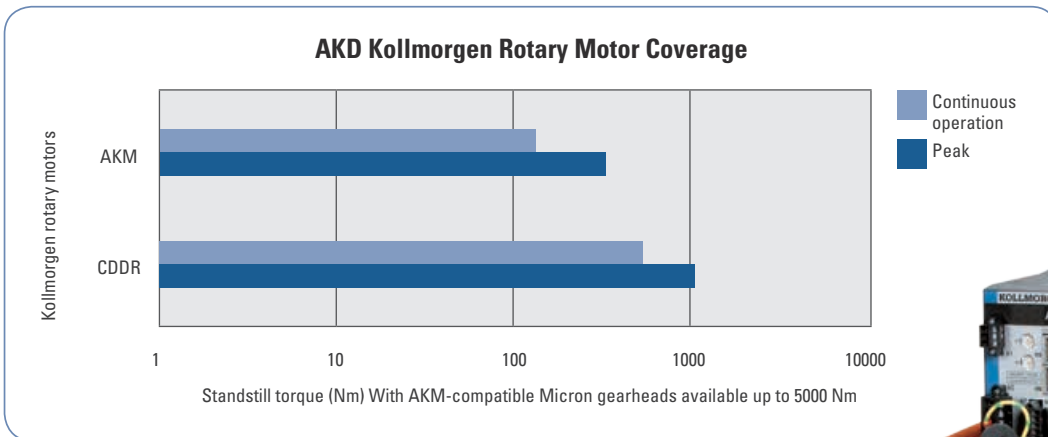
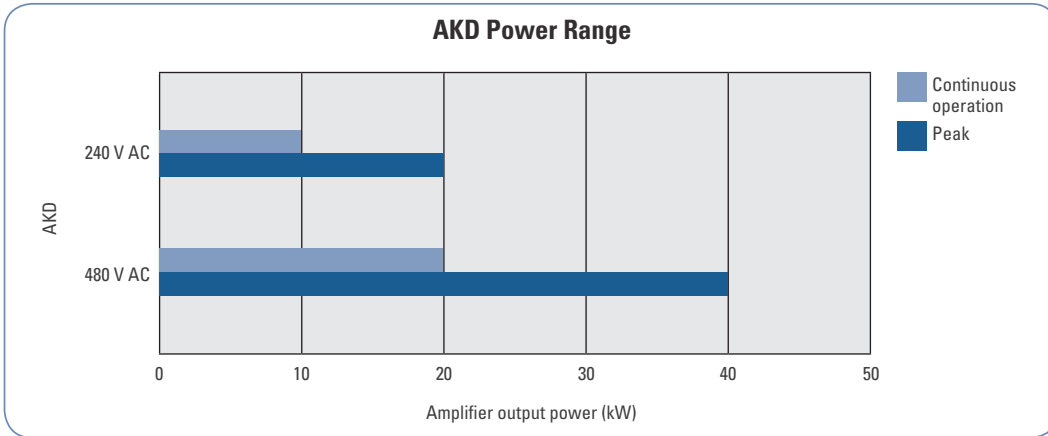

AKD[®] BASIC Servo Drives

Two-in-one: Servo Drive with Programmable Control

With AKD BASIC you can achieve control functions and motion control directly on the axis, even without an external PLC. Independently of the development team, you can optimize the drive and implement customer-specific requirements quickly, safely, and without intervention in higher-level control systems. This shortens the testing phase and prevents any surprises during start-up. With the easy-to-learn programming language BASIC, you can develop personalized programs for interface and motion control functions in no time. The Kollmorgen WorkBench supports you with powerful development tools, such as the program editor with syntax check, with program templates, and comprehensive testing and debugging tools.

Execute Customer-specific Functions quickly

- Simple, easy-to-learn programming in BASIC
- Implementation without intervention in the machine control system
- Convenient development environment: Workbench, program download and upload with one tool!
- Less hardware and lower installation costs
- Quick start-up with autotuning
- Program protection with password – protects against unauthorized intervention and secures your intellectual property

High Flexibility on the Axes

- 20 digital inputs and 13 digital outputs with I/O expansion
- 2 analog inputs and outputs with I/O expansion
- Saving of program and parameter sets onto SD cards; no PC necessary for start-up

AKD BASIC Interface Configurations

Interfaces	AKD BASIC basic device	AKD BASIC with I/O expansion
Digital inputs	8	20
Digital outputs	3	13
Analog inputs	1	2
Analog outputs	1	2



AKD BASIC basic device

AKD BASIC with I/O expansion

Increased Productivity: The Kollmorgen Workbench

With the Kollmorgen WorkBench you can see to all the work with and on the drive via a user interface – from the parameterization, configuration, optimization, and drive management, through to the programming of motion control and interface functions. The development environment for AKD BASIC forms part of the Kollmorgen WorkBench and contains all the tools for program development, testing, and troubleshooting.

- 1 The Kollmorgen WorkBench as a programming tool and axis management
- 2 Predefined commands and custom libraries simplify programming
- 3 The auto-complete function speeds up the work and reduces the frequency of errors by displaying the possible parameters in each case
- 4 Color-coding to safely distinguish between comments, parameters, print commands, and other types of code
- 5 Quick start-up through variable sharing with HMI
- 6 Intuitive operation thanks to a user-friendly menu structure
- 7 Debugger with jump instructions and breakpoints for controlling the program sequence in debug mode
- 8 Always clear thanks to the Windows user interface with configurable window arrangement

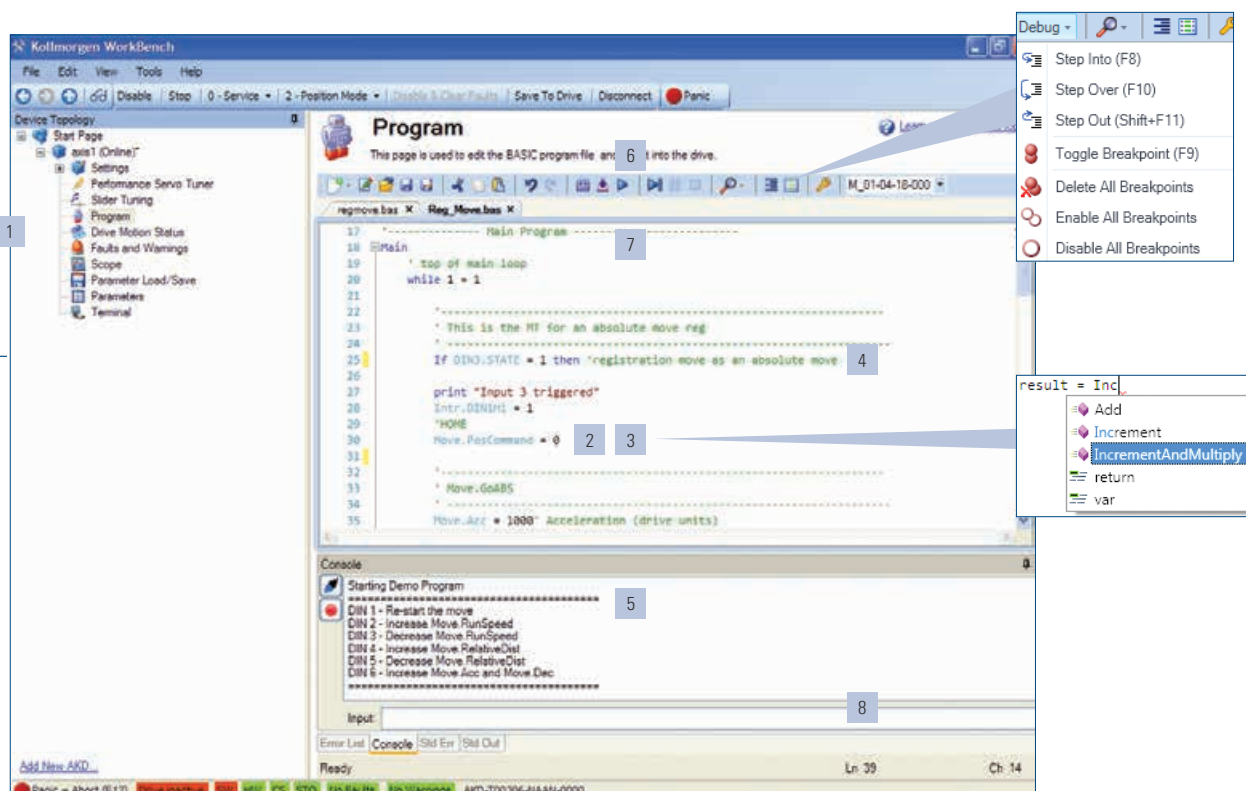

AKD[®] PDMM

Motion Controller, PLC, and Servo Drive in One Device

Outstanding in terms of flexibility and performance: Supplied in two performance categories, the AKD PDMM (Programmable Drive Multi Master) controls 10 or more axes* at 1-ms cycle time in the 800 MHz version, 20 or more axes* in the 1.2-GHz version, and also offers PLC functionality without an additional motion controller. You therefore save space in your switch cabinet, reduce wiring complexity, and lower machine costs. The Kollmorgen Automation Suite (KAS) development environment assists you with programming and reduces development times considerably – irrespective of whether it is a single-axis drive or a drive system with 50 axes.

* With increased cycle time

Technical Data

120/240 V AC 1 and 3-phase	Continuous current (A _{eff})	Peak current (A _{eff})	H (mm)	W (mm)	D (mm)
AKD-M00306-Mx*EC-D000	3	9	168	89	156
AKD-M00606-Mx*EC-D000	6	18	168	89	156
AKD-M01206-Mx*EC-D000	12	30	196	96	187
240/400/480 V AC 3-phase	Continuous current (A _{eff})	Peak current (A _{eff})	H (mm)	W (mm)	D (mm)
AKD-M00307-Mx*EC-D000	3	9	256	100	185
AKD-M00607-Mx*EC-D000	6	18	256	100	185
AKD-M01207-Mx*EC-D000	12	30	256	100	185
AKD-M02407-Mx*EC-D000	24	48	306	105	228
AKD-M04807-Mx*EC-D000	48	96	320	180	225

* x=C: 0.8-GHz version, x=1: 1.2-GHz version

Features

- The Kollmorgen Automation Suite is a comprehensive piece of automation software with effective tools for programming and start-up.
- Real-time-capable control with EtherCAT Master integrated in an AKD servo drive
- Programming interface as per IEC 61131-3 with full support of the five programming languages
- Reduced development times during drive programming with the Pipe Network™, the intuitive, graphical programming languages, or alternatively with PLCopen
- 128 kB of non-volatile memory for the secure storage of important machine and process data
- SD card slot for backing up and restoring application software, firmware, and control parameters without a PC
- Local digital and analog inputs and outputs: 13 digital inputs, four digital outputs, an analog input, an analog output (expandable using AKT series EtherCat bus terminals)
- Direct connection of the operating device through the integrated Kollmorgen Visualization Builder (KVB) HMI software and full support of the Kollmorgen AKI series operating devices
- A central connection for the PLC, HMI, motion control, servo drive, and CAM Designer
- Shorter start-up times due to error detection using simulation during application development
- Simple integration into available automation architectures with integrated Ethernet/IP, ProfiNet, or ModbusTCP interfaces
- Integrated web server for maintenance work, no software installation required



Kollmorgen Automation Suite (KAS)

Scalable Development User Interface

The Kollmorgen Automation Suite simplifies and speeds up development using a standardized software and hardware system. This scalable automation solution offers a fully integrated development environment for every application; be it a single drive or a drive system with AKD PDMM with up to 50 axes.

The Kollmorgen Automation Suite demonstrably achieves:

- An increase in product throughput with industry-leading drive performance by up to 25%
- A reduction in rejects by up to 50% thanks to first-class precision, seamless restarting after a stop or fault, and due to direct, highly dynamic process adjustments
- Increased precision for improved quality, less rejects, and shorter downtimes due to the quick and high-performance EtherCAT real-time bus
- More flexible, more sustainable, and more innovative machines with measurably higher marketability and profitability

A Comprehensive Family of Products

Kollmorgen servo drives deliver high-performance peak technology and compact designs. From simple torque and acceleration applications, to position applications, right through to fully-synchronized multi-axis motions, these servo drives, equipped with many comprehensive functions, offer:

- Plug-and-play compatibility with our AKM servo motors
- All the advantages of the wide-ranging selection of motor platforms from Kollmorgen, such as AKM™, Cartridge DDR™, and other direct drive technologies
- Extremely quick speed and position control loops
- Patented autotuning with frequency analysis for the perfect drive with the highest bandwidth
- Real-time data acquisition from all servo drives and many other devices

Our Best Servo Drive and Automation Solution in One Package

The programmable AKD PDMM servo drive with a master for multiple axes is a combination of our AKD servo drive platform and all the functions of the Kollmorgen Automation Suite in a single package, which provides full PLC and synchronized motion functionality for eight or more axes.

The 2-in-1 servo drive solution offers unbeatable advantages for your projects. You can rely on a single source for all drive components and a common experience on which you are dependent for building a better machine.

With the AKD PDMM, peak performance in machine development and automation is made simpler, quicker, and more cost-effective than ever before.



AKD Servo Drives

AKD is specifically designed with the versatility, communications, and power you need to expand machine performance and increase integration speeds. Motor set-up mostly occurs through plug-and-play and offers a diverse selection of feedback. In terms of the variety of Ethernet connection possibilities, options for both open and closed protocols are available. Online troubleshooting and data verification enable faster, bug-proof programming. And a broad power range in a smaller, compact design allows you to use these robust drives with a single interface.

Performance Data

Servo loop	Switching frequency	Bandwidth (max.)
Current loop	1.5 MHz (0.67 μ s)	5.0 kHz
Velocity loop	16 kHz (62.5 μ s)	1.6 kHz
Position loop	4 kHz (250 μ s)	0.8 kHz

Inputs / outputs		
Digital input events	16 kHz (62.5 μ s) update rate	
Encoder output or auxiliary encoder output	2.5 MHz maximum frequency	
Feedback	Digital resolver (SFD), EnDat2.2, EnDat2.1, BiSS, analog sin/cos encoder, incremental encoder, HIPERFACE® and resolver	
Logic supply	24 V DC	
	Base	With I/O expansion*
Digital input (24 V DC)	8 (1 controller enable)	20 (1 controller enable)
Digital output (24 V DC)	3 (1 fault signal relay)	13 (1 fault signal relay)
Analog input (+/- 10 V DC, 16-bit)	1	2
Analog output (+/- 10 V DC, 16-bit)	1	2
Programmable inputs	7	19
Programmable outputs	2	12
Sink/Source inputs/outputs	Yes	Yes

* AKD-T only

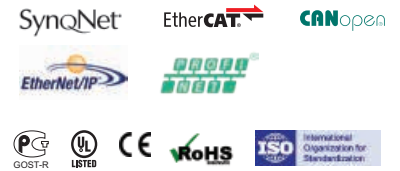

General Specifications

120 / 240 V AC 1-ph / 3-ph (85 - 265 V)	Continuous current [A _{eff}]	Peak current [A _{eff}]	Amplifier continuous input power [kW]	Internal dyn. Brake [kW] [0hm]		Height [mm]	Width [mm]	Depth [mm]	Depth with cable bend radius [mm]
				Change Motion task profile and clear fault with DRV. CLRFAULTS.	Change Motion task profile and clear fault with DRV. CLRFAULTS.				
AKD-x00306	3	9	1.1	Change Motion task profile and clear fault with DRV. CLRFAULTS.	Change Motion task profile and clear fault with DRV. CLRFAULTS.	168	59	156	185
AKD-x00606	6	18	2	Change Motion task profile and clear fault with DRV. CLRFAULTS.	Change Motion task profile and clear fault with DRV. CLRFAULTS.	168	59	156	185
AKD-x01206	12	30	4	0,1	15	196	78	187	max. 215
AKD-x02406	24	48	8	0,2	8	238	100	228	max. 265
480 V AC 3-ph (187 - 528 V)	Continuous current [A _{eff}]	Peak current [A _{eff}]	Amplifier continuous input power [kW]	Internal dyn. Brake [kW] [0hm]		Height [mm]	Width [mm]	Depth [mm]	Depth with cable bend radius [mm]
AKD-x00307	3	9	2	0,1	33	256	70	185	max. 225
AKD-x00607	6	18	4	0,1	33	256	70	185	max. 225
AKD-x01207	12	30	8	0,1	33	256	70	185	max. 225
AKD-x02407	24	48	16	0,2	23	306	105	228	max. 265
AKD-x04807	48	96	32	Change Motion task profile and clear fault with DRV. CLRFAULTS.	Change Motion task profile and clear fault with DRV. CLRFAULTS.	320	180	225	max. 265

AKD Servo Drive

Functionality

Ethernet Connectivity

- The Ethernet-based AKD range offers the user a choice of several bus systems:
- EtherCAT® (DSP402 protocol), Modbus/TCP, SynqNet®, PROFINET RT® and EtherNet/IP®
- No option cards necessary

Standard Bus Systems

- EtherCat®
- CANopen®

Industrial Design

- Robustly designed circuits and a compact housing for a space-saving, modern design – increased immunity against electrical interference and minimized emission of electrical disturbances
- Full fault protection
- UL, cUL, and CE approval
- No external mains filters required for CE and UL conformance (480 V AC units)
- Simple connections through screwable connector terminals
- Common use of the DC bus possible

Safe Torque Off (STO)

(IEC 61508 SIL2-certified)

- Switches the power stage off to ensure the safety of personnel and to prevent an unwanted restart of the amplifier – even during faults.
- Allows for the maintenance of logic functions and communication during power stage deactivation

Internal Dynamic Brake Resistor

(all models except 120/240 V AC 3 A_{eff} and 6 A_{eff}, as well as 480 V AC, 48 A_{eff})

- Simpler system components
- No costs for external braking resistors if the internal brakes suffice

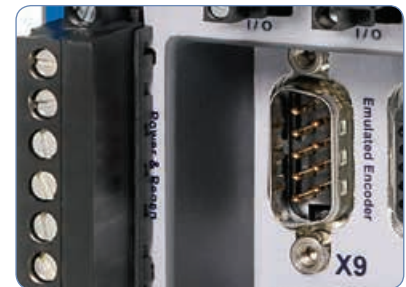

Autotuning

- Optimized performance through automatic, guided, or manual optimization
- Balances moment of inertia mismatches up to 1000:1
- Exceptional bandwidth under normal and heavy-load conditions – irrespective of the machine's mechanical bandwidth

Plug-and-Play Compatible with Kollmorgen Motors

- Electronic rating plates enable the automatic loading of parameters for quick start-up
- Programming of motion profiles within seconds
- Simple input of customer-specific parameters

I/O (Base Amplifier)

- 8 digital inputs (1 controller enable)
- 2 high-speed digital inputs (maximum time delay of 1.0 μs)
- 3 digital outputs (1 fault signal relay)
- 1 analog input – 16-bit
- 1 analog output – 16-bit

Connector Arrangement

AKD 120/240 V AC

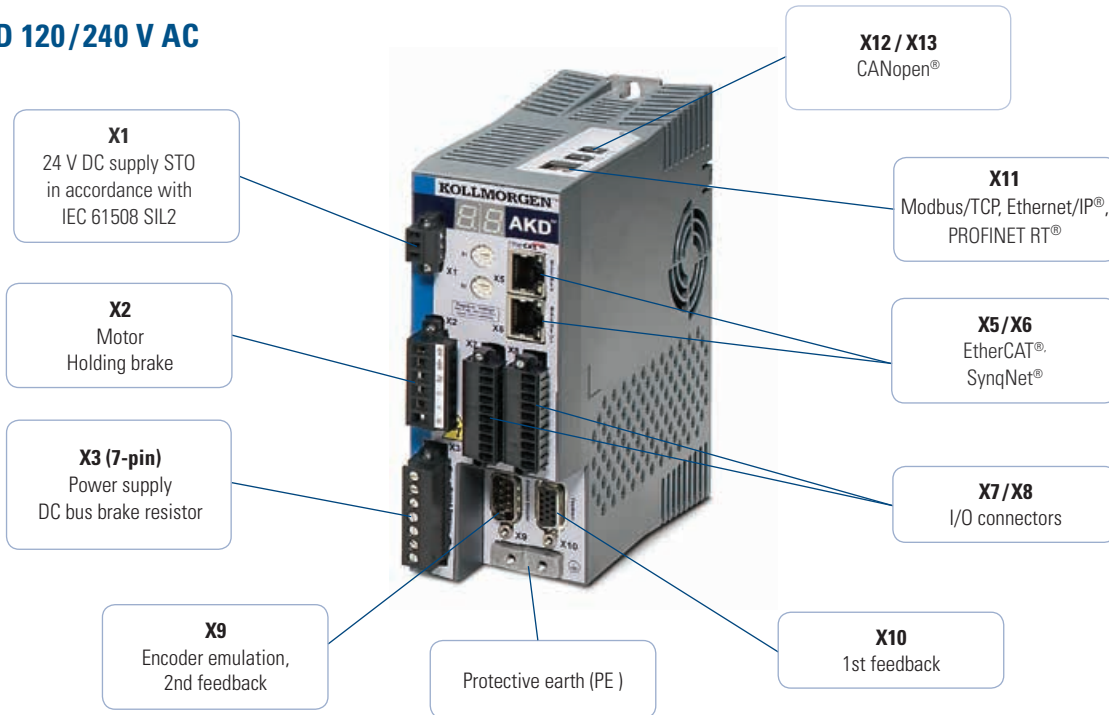

AKD 480 V AC

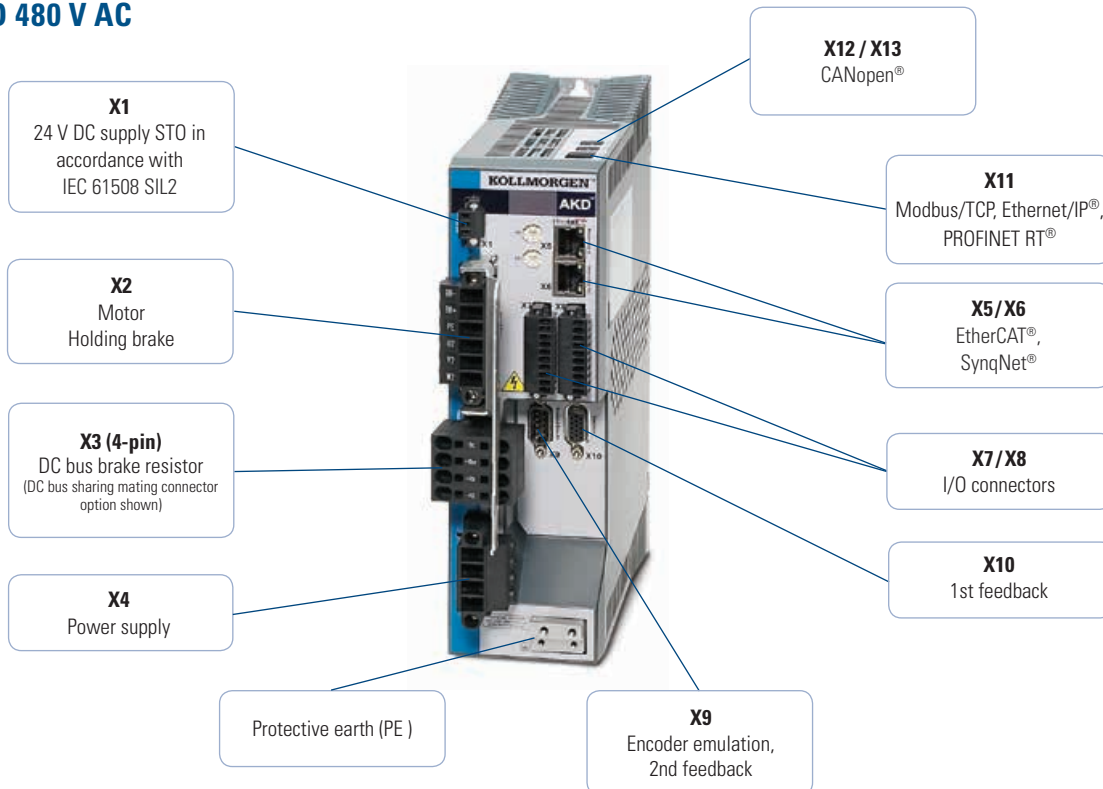

Kollmorgen WorkBench

The Kollmorgen WorkBench with AKD offers the user a simple and clear user interface to simplify and speed up development. From easy application selection and reduced math, to a six-channel oscilloscope, the user interface is extremely easy to use. Kollmorgen WorkBench also enables easy, automatic optimization of the AKD with Kollmorgen motors.

User-friendly Environment

Logical workflow, colorful icons, and easy access simplify interactions with AKD. The folder structure allows for instant identification and simple navigation.

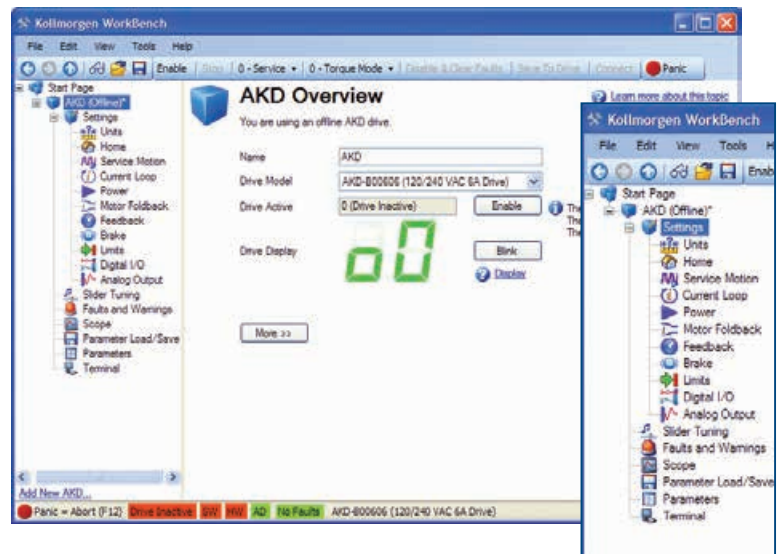

Six-Channel "Real-time" Software Oscilloscope

The easy-to-use AKD interface boasts a digital oscilloscope which provides users with a comfortable environment to monitor performance. Multiple options are available for selection to share the data in the format you prefer with a simple click of the mouse.

- Save as an image
- Send as an e-mail
- Print

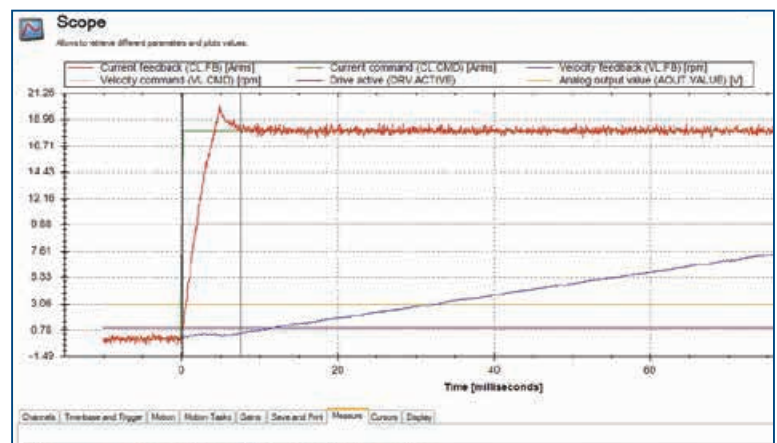

Application Selection

Simplifies set-up by allowing use of machine or application-based units. Illustrated set-ups: Nip roller and rack / pinion

Application Selection: Nip Roller

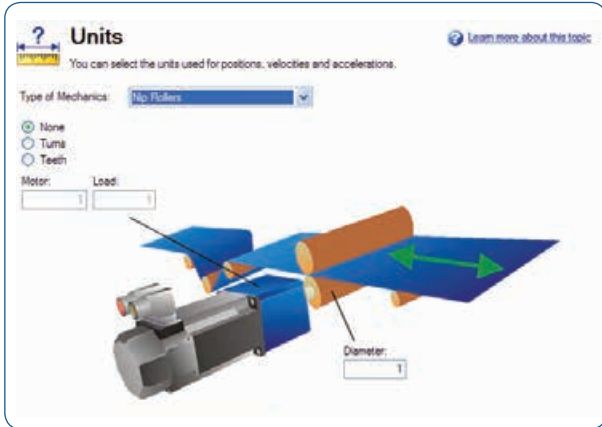

Application Selection: Rack and Pinion

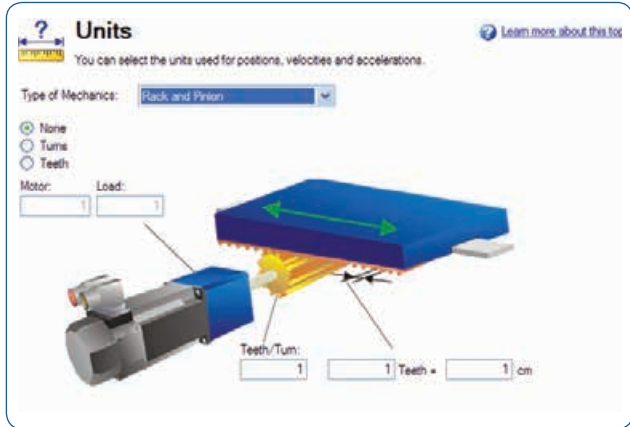

Data-Sharing

The parameters window also allows for simple data-sharing. Kollmorgen WorkBench provides the user the easy options of printing and sending the parameters at the click of a button.

Parameters

This page lists all the current values of all the drive parameters on the drive.

Full Name	Value	Units	Parameter	Read/Write
Active Disable				
Deceleration during active disable	3000.000	rpm/s	AD.DEC	read-write
Time-out	1000	ms	AD.DISTO	read-write
State	0	ms	AD.STATE	read-only
Velocity window	120.000	rpm	AD.VELTHRESH	read-write
Time delay after velocity window	6	ms	AD.VELTHRESHTM	read-write
Analog Input				
Analog input low pass filter cutoff freq...	5.000.000	Hz	AIN.CUTOFF	read-write
Analog input signal deadband	0.000	V	AIN.DEADBAND	read-write
Analog input mode	0 - Inactive		AIN.MODE	read-write
Analog input offset	0.000	V	AIN.OFFSET	read-write
Analog input signal	0.000	V	AIN.VALUE	read-only
Analog Input/Output				
Analog input torque scale	0.001	A/V	AIO.ISCALE	read-write
Analog input velocity scale	0.060	rpm/V	AIO.VSCALE	read-write
Analog Output				
Analog output mode	0 - User Variable		AOUT.MODE	read-write
Analog output value	0.000	V	AOUT.VALUE	read-write
Bode				
Current Loop				
Current command	0.000	A	CL.CMD	read-only
Current command - user	0.000	A	CL.CMDU	read-write
Current command - D component	0.000	A	CL.DCMD	read-only
Current command - user D component	0.000	A	CL.DCMDU	read-write

Find:

Group

Drive Parameter List - Message (Plain Text)

File Edit View Insert Format Tools Actions Help

Send

To:

Cc:

Bcc:

Subject: Drive Parameter List

Attach... DriveParameterList.csv (16 KB)

Drive Parameter List is attached.

AKD-N™ Decentralized Servo Drive

The new decentralized AKD-N servo drives from Kollmorgen can be placed in the immediate vicinity of the motor thanks to its robust, compact construction and protection class IP67. Plug-in connections, excellent motor compatibility and high degree of integrated functionality: With the decentralized AKD-N servo drives, you can develop drive and automation architectures that are easily comprehensible, and integrate with the central AKD servo drives. Using EtherCAT as a system bus, we reduce complexity further since the AKD-N can collect I/O signals on the axis and pass them on in bundled form.

Improved Overall Equipment Effectiveness (OEE)

With AKD-N you increase the effectiveness beyond the entire life cycle of your machine (OEE, Overall Equipment Effectiveness). The design configuration and simple connection technology decrease the time for assembly, installation, and start-up. During the operating phase, the AKD-N plays a valuable part in energy savings due to the integrated DC connection. Further advantages in production are faster cleaning cycles thanks to a higher protection class as well as fewer cables in combination with a space-saving switch cabinet superstructure. Moreover, the assembly and connection technology increases the availability – and thereby productivity – because maintenance and service tasks are completed faster.

The Advantages of Decentralized Servo Drives

- | | |
|--|---|
| <ul style="list-style-type: none"> • Reduced costs | <ul style="list-style-type: none"> • Reduced cabling because DC and fieldbus, power supply, I/O level as well as safety (STO) run in one cable • Faster and simple assembly, even without special knowledge, through ready-made and tested cables • Lack of derating enables smaller motor and servo drive combinations compared to integrated system with the same output power |
| <ul style="list-style-type: none"> • Compacter machines | <ul style="list-style-type: none"> • Smaller and therefore more easily integrated switch cabinets • Servo drives in the immediate vicinity of the motor • Robust construction in Protection class IP67 makes protective enclosures superfluous |
| <ul style="list-style-type: none"> • Faster startup | <ul style="list-style-type: none"> • Plug connectors in IP67 for connection without tools • At only eleven millimeters, the thin hybrid cable can be laid in a space-saving manner – even in tight machine corners, thanks to a small bending radius • Simple connection of I/O systems or fieldbuses directly to the drive • Parameterization with the tools of the Kollmorgen WorkBench |
| <ul style="list-style-type: none"> • Higher machine effectiveness (OEE) | <ul style="list-style-type: none"> • Design supports fast and effective cleaning • High operating safety through robust construction • Precision through digital feedback • Everything at a glance: Status display on servo drive |
| <ul style="list-style-type: none"> • More flexibility in machine design | <ul style="list-style-type: none"> • Compatible with all motors from Kollmorgen with single- or dual-cable connection • Simple combination of central and decentralized controllers within the comprehensive AKD family • Faster modification and upgrade options through linear topology as well as I/O and fieldbus interfaces at the axis |

AKD-N Decentralized Servo Drives

Our Way of Making Machines Simpler and More Efficient

AKD-N DECENTRALIZED SERVO DRIVES

- Advantage: Lower machine complexity
- Advantage: Greater freedom of design
- Advantage: Higher OEE (Overall Equipment Effectiveness)



- Complete integration in the AKD family

- Decentralized solution reduces effort and costs for switch cabinet

- Startup with the Kollmorgen WorkBench

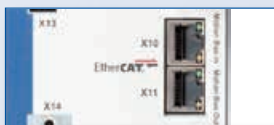

- MotionBus (EtherCAT) for connection to automation systems

- Connection of external additional components

- A single AKD-C supplies up to 16 AKD-N

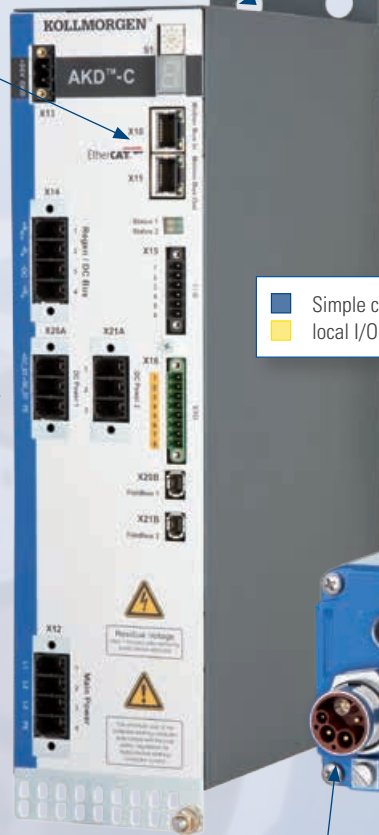

- Simple connection of local I/O

- Status LED for simple diagnosis

- Options like tertiary fieldbus and local STO offer maximal flexibility

- IP67 / UL type 4x housing reduces cleaning times and makes special protective enclosures redundant.

- Simple and fast attachment

- Compatible with all motors from Kollmorgen



- A single cable with 11 mm diameter for DC bus, electrical supply, EtherCAT fieldbus and STO reduces cabling outlay, increases the reliability and enables flexible machine design

- Hybrid motor cable for simplified cabling, faster installation and higher reliability

Why Lay 372 m of Cable when 42 m Will Suffice?

Imagine your machine includes eight axes each with a distance of three meters. The switch cabinet is 5 meters away and on each axis there is also a switch. With this thoroughly realistic example, that equates to a total of 372 meters of cable – with our AKD-N it would have been 42 meters. The decentralized servo technology of the AKD-N saves 330 meters here! That is cable that does not have to be purchased or laid and which does not require any space in the machine construction. We find that these are very good grounds for starting the comparison. We combine the AKD-N servo controllers and their power supply modules with pre-assembled and tested system cables – it doesn't get much simpler than this.

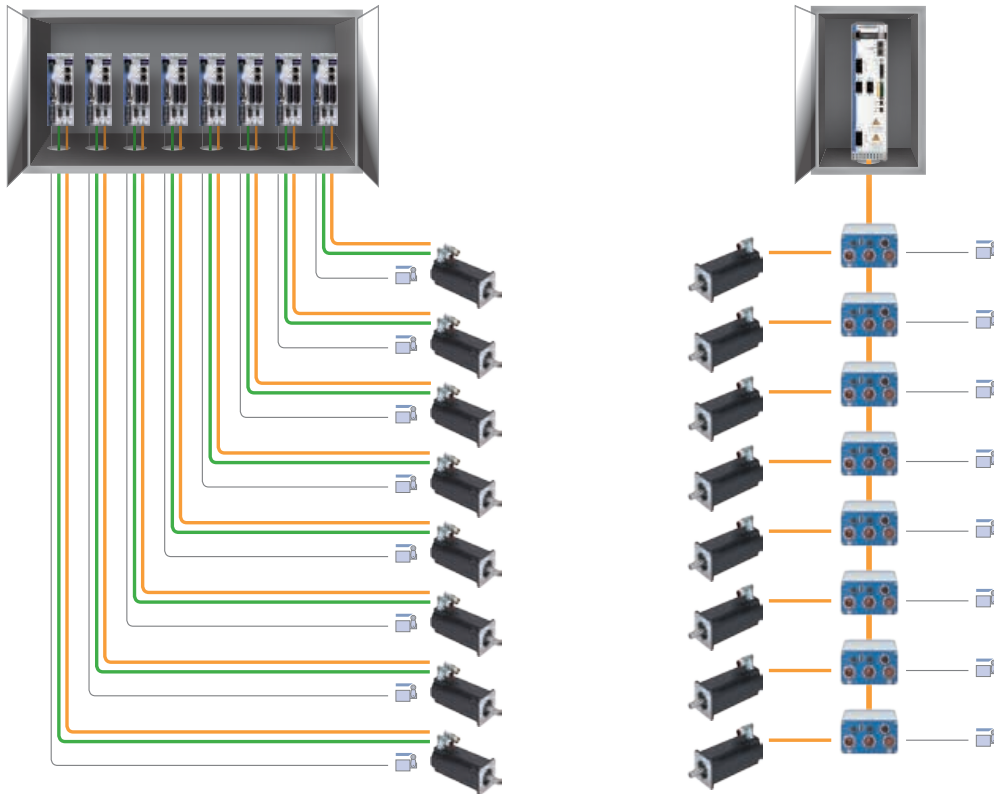

Regardless of which Motor: Plug and Play

Our AKD-N decentralized servo controllers work optimally with every motor. Within our Kollmorgen system, you can also thoroughly use all advantages of the single-cable connection technology individually.

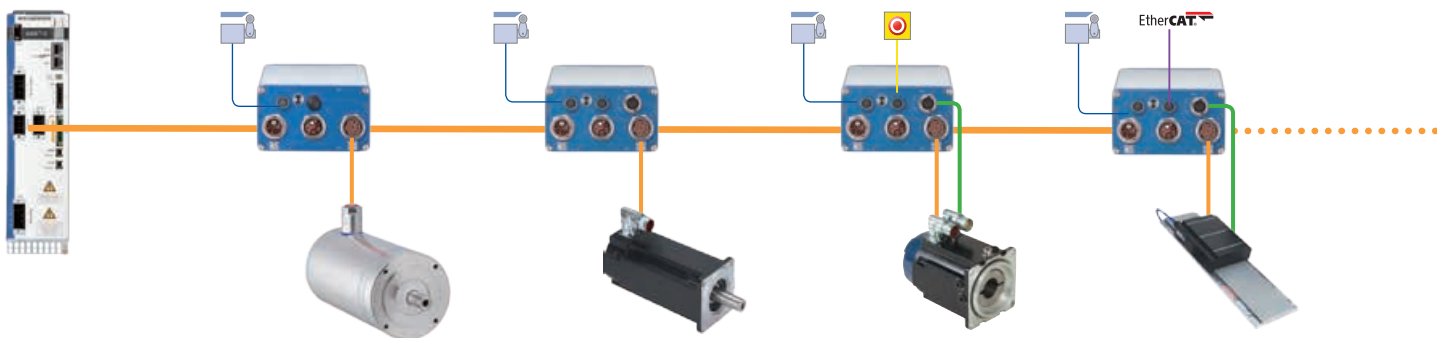

AKD-N Decentralized Servo Drives

Technical Data and Topology

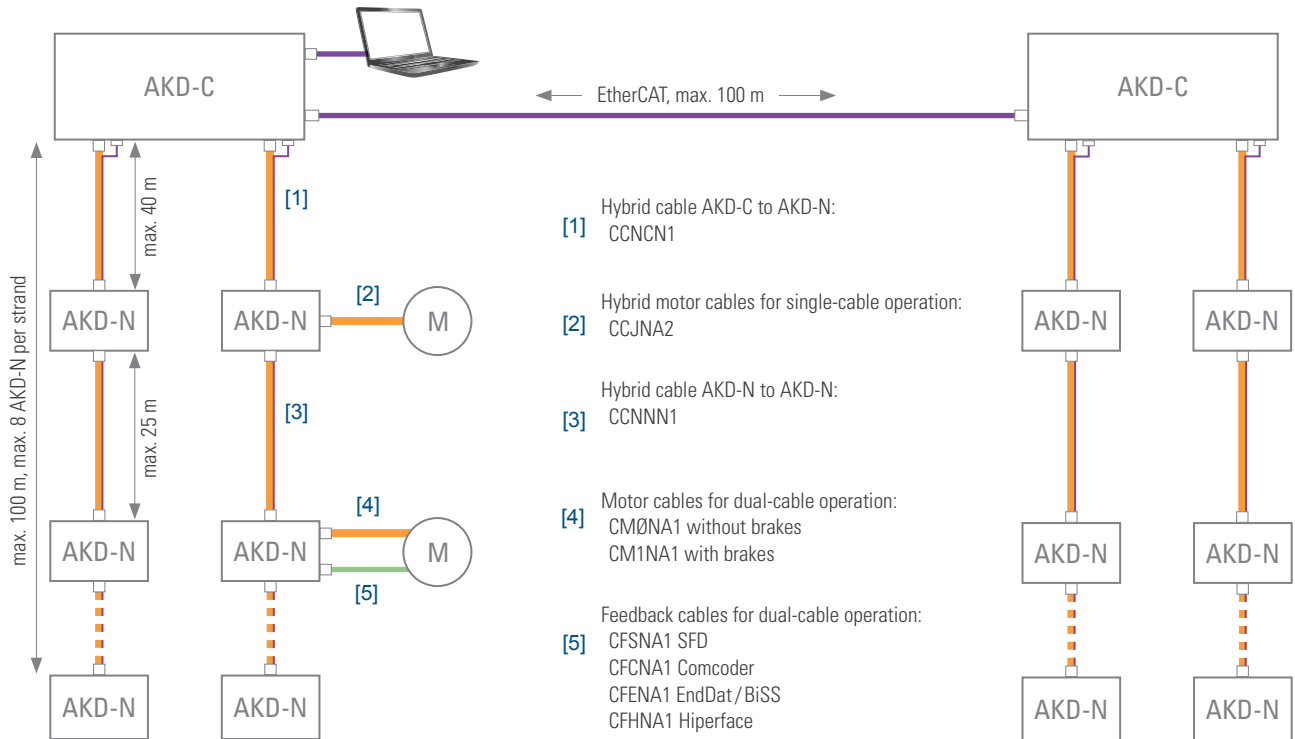

AKD-N Decentralized Servo Drives

Continuous current	3 A, 6 A
Peak current	9 A, 18 A
Continuous input power	1.5 kVA, 3 kVA
Protection class	IP67
Digital inputs/outputs	3 digital inputs/ 1 digital output
Safety function	STO SIL 2 (only AKD-N-DS)
Feedback systems Dual-cable (not with -DB)	SFD (digital resolver), BISS-C, Comcoder, hall sensor, Endat 2.1 and 2.2, Hiperface, Hiperface DSL
Feedback systems Single-cable	SFD3 (digital resolver) and Hiperface DSL
Communication	EtherCAT
Dimensions (W x H x D)	Housing: 130 x 75 x 201 (mm) With plugs 130 x 75 x 247 (mm)

AKD-C Power Supply Module

Line voltage	400 / 480 V
Overall performance	10 kW
Intermediate circuit voltage	560 / 680 V DC
Output current	17 A (peak 34 A)
Protection class	IP20
Output strands	2, for up to 8 AKD-N apiece
Safety function	one STO Enable and STO Status apiece for each strand, SIL 2
Digital inputs/outputs	1 input, 1 output, 1 relay output
Communication	EtherCAT, TCP/IP service interface
Dimensions (W x H x D)	Housing (Front) 80 x 260 x 198 (mm) Installation dimension with plugs 80 x 329 x 231 (mm)

Connections and Controls

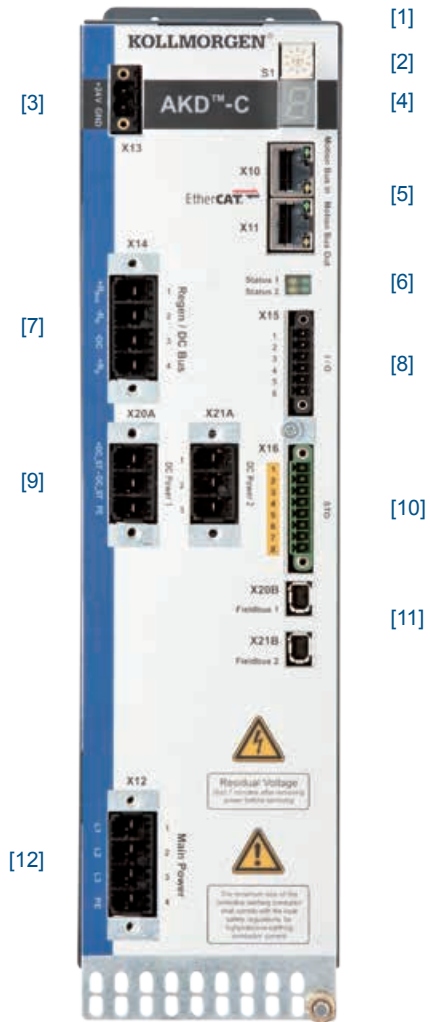

- [1] Network connection for service PC (TCP/IP) (on the top)
- [2] Setting the IP address
- [3] 24 V DC power supply
- [4] Error and status displays
- [5] Motion Bus I/O connections (EtherCAT)
- [6] Status display of the local fieldbus
- [7] Connection for external brake resistor and KCM buffer module
- [8] I/O (1 each digital input and output, 1 relay output)
- [9] DC outputs for connection of up to eight decentralized AKD-N servo drives apiece
- [10] STO input, STO status output (one each per strand),
- [11] Local fieldbus for communication with AKD-N
- [12] Power connection 400 V / 480 V AC

Connection Options for AKD-N

AKD-N-	Single-cable technology	Separate feedback	Digital I/O	Tertiary fieldbus	Local STO
DB	✓	—	✓	—	—
DF	✓	✓	✓	✓	—
DS	✓	✓	✓	—	✓

AKD-N-DB Decentralized Servo Drives

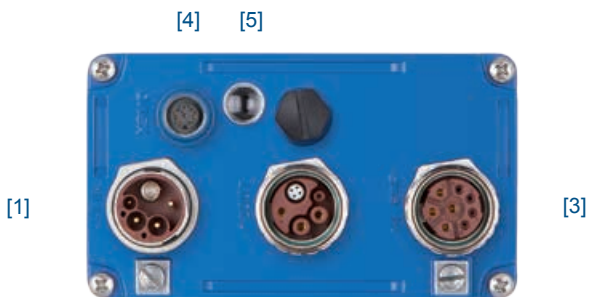

- [1] [2] Connections for hybrid cable
- [3] Motor connection
- [4] 3 digital inputs, 1 digital outputs
- [5] Status/error display with LED

AKD-N-DS, -DF Decentralized Servo Drives

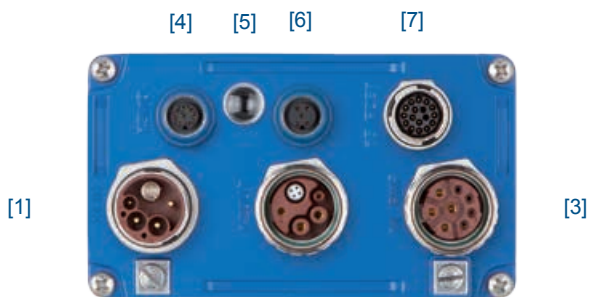

- [1] [2] Connections for hybrid cable
- [3] Motor connection
- [4] 3 digital inputs, 1 digital outputs
- [5] Status/error display with LED
- [6] STO connection (-DS) / Tertiary fieldbus (-DF)
- [7] Connection for feedback with dual-cable technology

S700 Servo Drives

Integrated safety functions contribute to increased machine availability and therefore increase productivity. The S700 models include a verified STO (Safe Torque Off) function as standard. The optional safety enhancement cards enable numerous safety functions such as "Safe Stop", "Safe Limited Speed", and "Safe Direction" for SIL2 or SIL3 applications.

All S700 servo drives use standardized, high-performance control technology. Rapid current, speed, and position control offers maximum performance and ensures that all axes are optimally synchronized at all times. Very quick and precise control allows for shorter work cycles and therefore considerable increases in productivity.

Specific application tasks and functions can be programmed with the integrated macro language (IEC 61131). The Macrostar development tool enables the implementation of expanded processes for individual axes.

Practical functions such as autotuning, Bode plots, and cogging suppression simplify optimization, both for applications with high dynamics and also those with high precision.

The Advantages of S700 Servo Drives

- | | |
|--|---|
| <ul style="list-style-type: none"> • Higher productivity | <ul style="list-style-type: none"> • Very quick current, speed, and position control increase machine cycle rates • SIL2 and SIL3 safety functions in accordance with IEC 61508 increase machine availability • Many reference run methods • 200 motion tasks can be saved • Integrated macro language for high-performing drive tasks |
| <ul style="list-style-type: none"> • A version for all applications | <ul style="list-style-type: none"> • Multi-interface • Multi-feedback • Synchronous servo motors • Direct drives, rotary and linear drives • Asynchronous motors • HF motors • DC motors |
| <ul style="list-style-type: none"> • Smaller switch cabinets | <ul style="list-style-type: none"> • Integrated EMC filters • Mains supply integrated • Brake resistor integrated for up to 24 A of nominal current • No mains choke usually necessary |
| <ul style="list-style-type: none"> • Faster start-up | <ul style="list-style-type: none"> • Memory card for parameter and firmware updates • All connections via connectors • Autotuning |
| <ul style="list-style-type: none"> • User-friendly | <ul style="list-style-type: none"> • Specific setup depending on the type of application • SI units calculator • Context-sensitive online help • Wiki system for technical background information |

S700 Servo Drives

Universal with Optional Safety Functions

The S700 range of servo drives has been designed for universal use with synchronous servo motors, asynchronous motors, DC motors, HF motors, and rotary and linear direct drives. The S700 offers a function for suppressing cogging torques within defined traverse distances. This function has been specifically designed for applications with the toughest synchronism requirements. Even linear motors can be operated at extremely low speeds with a high degree of synchronous accuracy. For all application options, the DriveGUI setup software offers a wide range of tools for easy start-up.

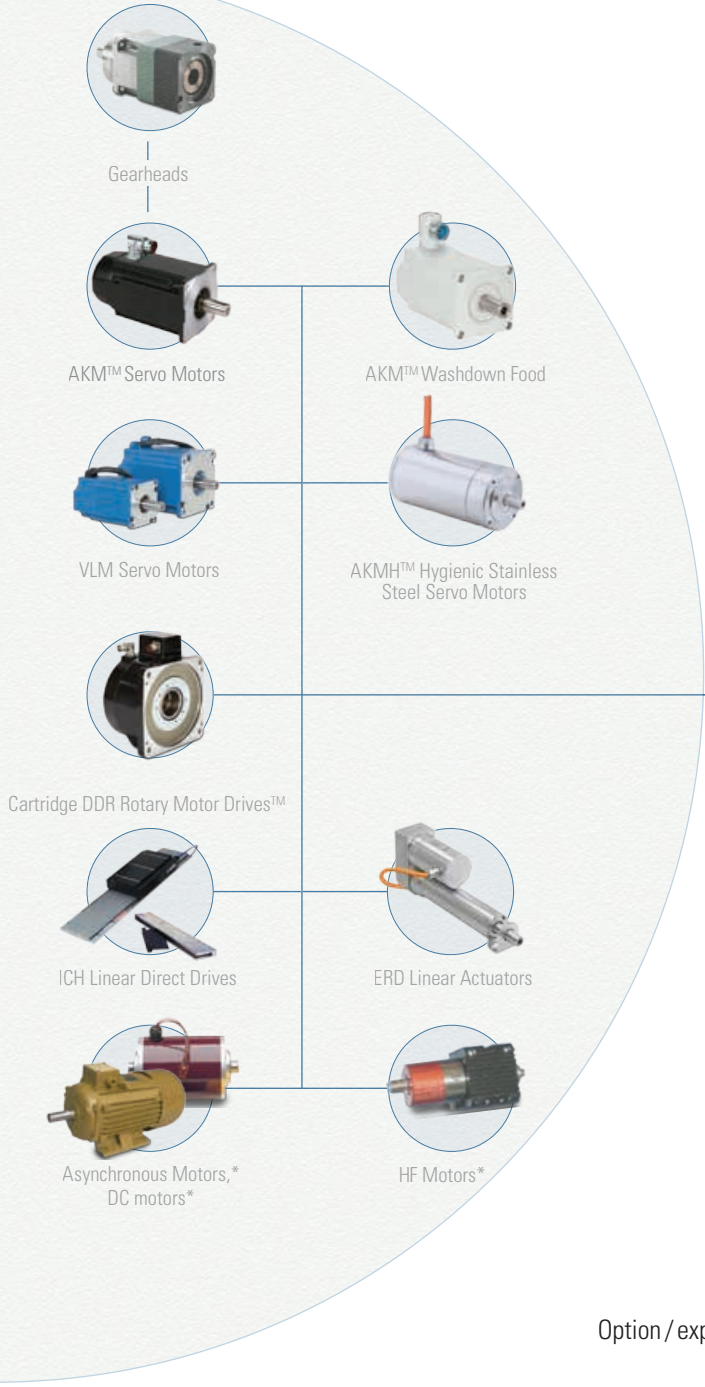

Series-produced bus options: **CANopen** Ether**CAT** **RS232**

Option / expansion card: **PROFINET** **DeviceNet** **SERCOS** **SynQNet**
the automation bus

*Third-party motor types

S700 series digital servo drives are available in rated current options of 1.5 A, 3 A, 6 A, 12 A, 24 A, 48 A, and 72 A. Customers can benefit from a consistent servo concept from a single source, which enables time and cost savings in project development, installation, and start-up. The finely staged scaling of the drive powers allow optimum adjustment to the requirements of each individual axis in the system, resulting in outstanding overall machine performance.

General Specifications

Rated data	DIM	S701	S703	S706	S712	S712S*	S724	S724S*	S748	S772
Rated line voltage	Vac	1 x 110 V to 230 V, 3 x 208 V -10% to 3 x 480 V +10%							3 x 208 V to 3 x 480 V	
Rated line power for S1 operation	kVA	1.1	2.2	4.5	9	9	18	18	35	50
Auxiliary supply	Vdc	24								
Rated DC-link voltage	Vdc	290 to 675								
Rated output current (rms value)										
At 1 x 110 V	A _{eff}	1.5	3	6	7	7	10	10	It is also referred to as Commutation Alignment and Pole Locking.	It is also referred to as Commutation Alignment and Pole Locking.
At 3 x 110 V	A _{eff}	2.5	5	6	12	12	24	24		
At 1 x 230 V	A _{eff}	1.5	3	6	8	8	11	11		
At 3 x 230 V	A _{eff}	2	4	6	12	12	24	24	48	72
At 3 x 400 V	A _{eff}	1.5	3	6	12	12	24	24	48	72
At 3 x 480 V	A _{eff}	1.5	3	6	12	12	24	24	48	72
Peak output current	A _{eff}	4.5	9	18	24	30	48	72	96	140

* Higher peak current



S701 - 712



S724



S748 / 772

Dimensions (mm)

	DIM	S701	S703	S706	S712	S712S	S724	S724S	S748	S772
(H) Height incl. fan	mm	345					348		385	
(W) Width	mm	70					100		190	
(D) Depth incl. connector	mm	285							285	

S700 Servo Drives

Features

The S700 can read data from a wide range of feedback systems and evaluate three different systems in parallel. This ensures a high level of flexibility where integration the S700 into various applications is concerned. Control without a feedback system is also supported, e.g. in the case of asynchronous motors.

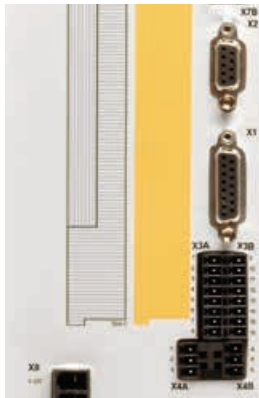

2 to 36-pin resolvers

Incremental encoder (AquadB) 24 V

Incremental encoder (AquadB) 24 V + hall-effect sensor

Pulse / direction, 24 V

Optional: SSI absolute encoder pulse / direction 5 V

SinCos encoder with BiSS

SinCos encoder with EnDat 2.2, EnDat 2.1

SinCos encoder with HIPERFACE

SinCos encoder without data track

SinCos encoder with hall-effect sensors

Hall-effect sensor

Incremental encoder (AquadB) 5 V

Incremental encoder (AquadB) 5 V + hall-effect sensor

Simple Configuration with DriveGUI Setup Software

With the graphic-based DriveGUI setup tool, you have access to all the S700 functions and parameters. You can therefore quickly configure all S700 interfaces, select all connected devices (e.g. motor type, feedback system, fieldbus) and the autotuning functions can be launched. The four-channel oscilloscope and Bode plot function ensure optimum display of the autotuning results.

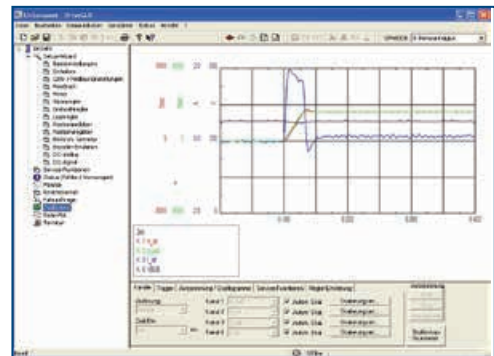

Integrated Macro Programming

The Macro Language forms part of the S700 firmware and enables independent, single-axis programmable positioning. Missing functions in the standard amplifier firmware can be programmed with IEC 61131 structured text. The MacroStar development tool supports the quick programming of functions with integrated variables and command catalogs.

- 62.5 μ s / 250 μ s / 1 ms / 4 ms / 16 ms / IDLE / IRQ
- 128 kByte code memory
- 400 simple instructions every 62.5 μ s
- CAN objects for multi-axis control

From a Drive to a Safe Drive: Safety Expansion Cards

The S700 safety concept is designed for level SIL3 or PL e. The use of standard hardware components enables flexible and cost-optimized solutions which can achieve a cost saving of up to 25% per axis due to the omission of customer-specific adjustments. Due to the secure processes, machine availability and, consequently, productivity increase by up to 20%.

The safety expansion cards equip the S700 with important safety functions that are activated by an external safety logic. The upgrade is very simple: The cards are simply inserted into the connector sockets provided on the S700 servo drive and then configured with the SafetyGUI configuration tool. Finished!

Extensive Safety Functions

Category	Function	S700	S700+S1-2	S700+S2-2
	Si level	SIL2/PL d	SIL3/PL e	SIL2/PL d
Safe stop functions	STO	✓	✓	✓
	SS1	—	✓	✓
	SS2	—	✓	✓
	SOS	—	✓	✓
Safe speed functions	SSR	—	✓	✓
	SLS	—	✓	✓
Safe direction functions	SDI	—	✓	✓
Safe brake control	SBC	—	✓	—
Safe position functions	SLI	—	✓	✓
	SLP	—	✓	—



Safety expansion card S2-2

Safety expansion card S1-2

Safety Solutions with the S700 Safety Concept

- Easy integration
 - Hardwired, compatible with almost every safe control system
 - Ideal for upgrading existing safety solutions
 - No external safety logic necessary
- Flexible
 - Upgradeable option cards
- Maximum safety functionality
 - Extensive safety functions are included
 - Very short response time thanks to direct access to the control electronics

Safe Motion

Why should a whole production line be brought to a standstill during user interventions when only one part of it is affected? Kollmorgen has put the idea of building drives with safe motion instead of safe standstill into practice with its Motion Safety solution that integrates the safety logic and monitoring within the drive. Without compromising on safety, drives utilizing or using Motion Safety achieve considerably higher productivity and offer more flexibility when adjusting to new requirements.

Kollmorgen offers safety expansion cards for installation in the S700 servo drive and the KSM compact and KSM modular safety control systems.

Make the Most of the Advantages of the Kollmorgen Motion Safety Strategy

- Higher productivity
 - Motion Safety enables user interventions in running processes
 - Safe motion instead of safe deactivation
 - Risk-dependent triggering of safety functions
- Low system costs
 - Optimal adjustment to requirements due to modular structure
 - Wide range of standard products
 - Safety control and drive monitoring in one device
- Flexible
 - Modular concept and simple upgrade of existing drives
 - Seamless transition from hardwired to configurable safety logic
- Simple and fast implementation
 - Important motion-related safety functions are integrated
 - Predefined safety function blocks
 - Intuitive tools for programming and parameterization in the field by the customer

Safe Motion

Safety Logic and Drive Monitoring Integrated within the Drive

Motion Safety – innovative safety technology from Kollmorgen. Motion Safety means: safe processing of sensor and actuator signals, safe motion monitoring, and safe communication directly in the drive. The result: significantly higher productivity when compared to conventional safety technology thanks to safe drive solutions.

With Motion Safety: Safe Motion Instead of Safe Standstill

Motion Safety combines the safety logic and the drive monitoring in the drive. Conventional safety technology keeps the user away from areas with dangerous motion. By contrast, drives with Motion Safety work according to the safe motion principle and permit user interventions without interrupting the process. The safety logic in the drive controls motion sequences so that no danger can result from them and the process is not interrupted.

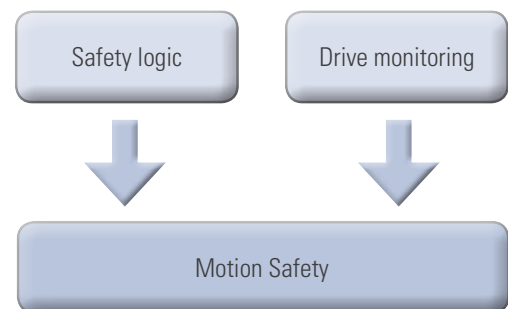

Productivity Gains with Motion Safety

Safety functions for areas with dangerous motion are activated when intervening in a running process. With intelligent safety functions, motion sequences are controlled so that each motion is safe. For example, this is performed through position monitoring and restricting the range of motion or by increasing the cycle times. Parts of the machine that do not constitute a risk to the user are not affected. The graph clearly shows the productivity gains when using Kollmorgen's Motion Safety technology.

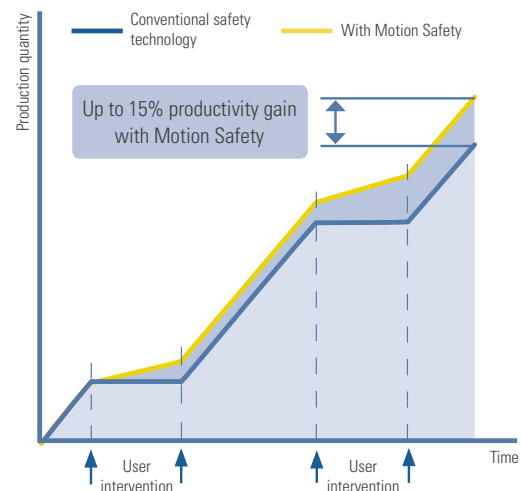

Kollmorgen – your Competent Partner for Safe Drive Solutions

As the leading manufacturer of electrical drive technology, Kollmorgen boasts extensive expertise gained from thousands of drive projects around the world. Safety logic, servo drives, motors, through to complete automation solutions – Kollmorgen supplies coordinated components for safe drive solutions, all from one source. Whether it is a standard implementation or a new development as part of a co-engineering project, make use of Kollmorgen's innovative capacity and experience for developing your safe drive.

Demanding Safety Solutions Realized efficiently

Safe Single-axis Drive with Minimum Response Time

S700 safety concept: The optional S1-2 S2-2 safety expansion cards equip the S700 servo drive with safety functions

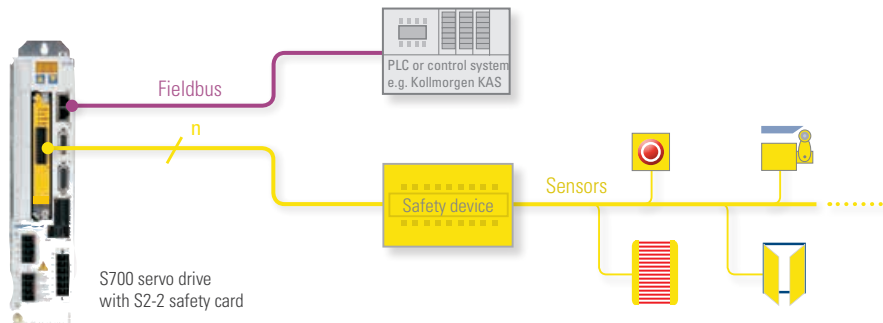

Compact, Simple Safety Solution for up to 2 Axes

KSM compact safety control system with AKD servo drive for drives with up to 2 axes and up to 32 secure I/O



High-Performance Safety Control System for Demanding Safety Requirements

KSM modular: The modular safety control system for demanding, safe drives with up to 12 axes and up to 200 secure I/O

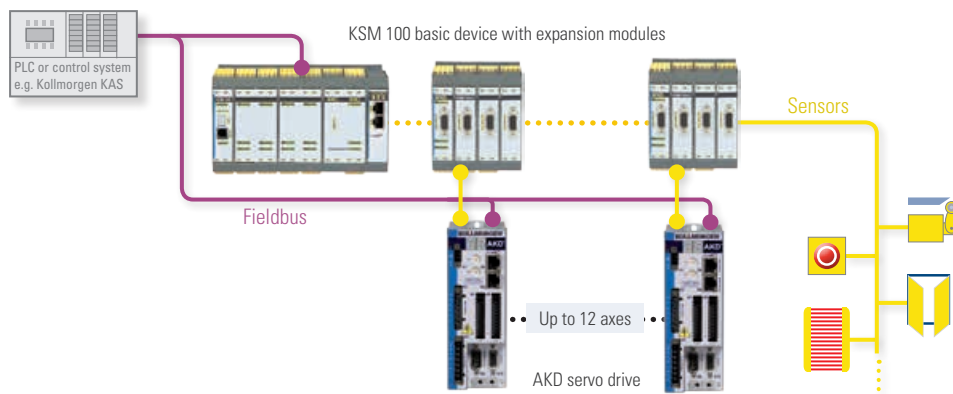

Safe Motion

Extensive Safety Functions for Safe Motion

STO (Safe Torque Off)

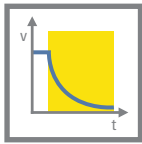

STO safely interrupts the power supply to the motor in the servo drive. The motor becomes torque-free.

SS1 (Safe Stop 1)

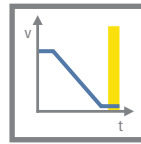

The drive is brought to a standstill by controlled braking. Then the power supply to the motor is safely interrupted and the motor becomes torque-free.

SS2 (Safe Stop 2)

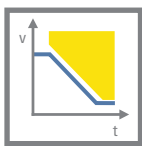

The drive is brought to a standstill by controlled braking and subsequently remains in controlled standstill. The control functions of the drive are maintained.

SOS (Safe Operating Stop)

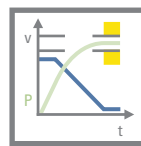

Monitors the stop position reached and triggers SS1 in the event of deviations beyond the specified limits. The control functions of the drive remain active.

SDI (Safe Direction)

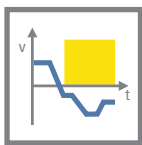

The SDI function ensures that the drive can only move in a defined direction. In the event of an error, SS1 is triggered.

SSR (Safe Speed Range) 1

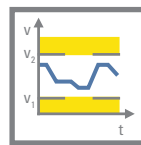

Monitors that the drive observes a defined speed limit. In the event of an error, SS1 is triggered.

SLS (Safe Limited Speed)

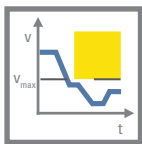

Monitors that the drive observes a defined speed limit. In the event of an error, SS1 is triggered.

SBC (Safe Brake Control), SBT

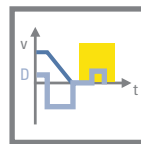

SBT (Safe Brake Test) (non-standardized)
Test function for external brakes and the internal motor holding brake

SLP (Safe Limited Position)

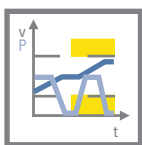

Monitors the absolute position of the drive. If the limit value is reached or the brake torque is too low to keep the drive within the limit value, SS1 is triggered.

SLI (Safe Limited Increments)

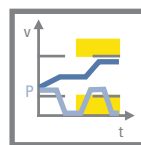

Monitors the relative position of the drive with respect to the current position when activating the SLI function. SS1 is triggered when the prescribed limit value is reached.

KSM Safety Control System

The Safety Chain for Motion from the Sensor to the Drive

Safe drive solutions with higher productivity: The KSM safety control system achieves SIL 3/PL e and perfectly meets the requirements of modern safety concepts thanks to its modular structure. From safe dual-axis drives with just a few safe I/O through to a 12-axis drive with 100 or more safe I/O, in combination with AKD servo drives and Kollmorgen automation solutions, you can develop expandable, safe drives that offer more power and higher productivity with lower system costs.

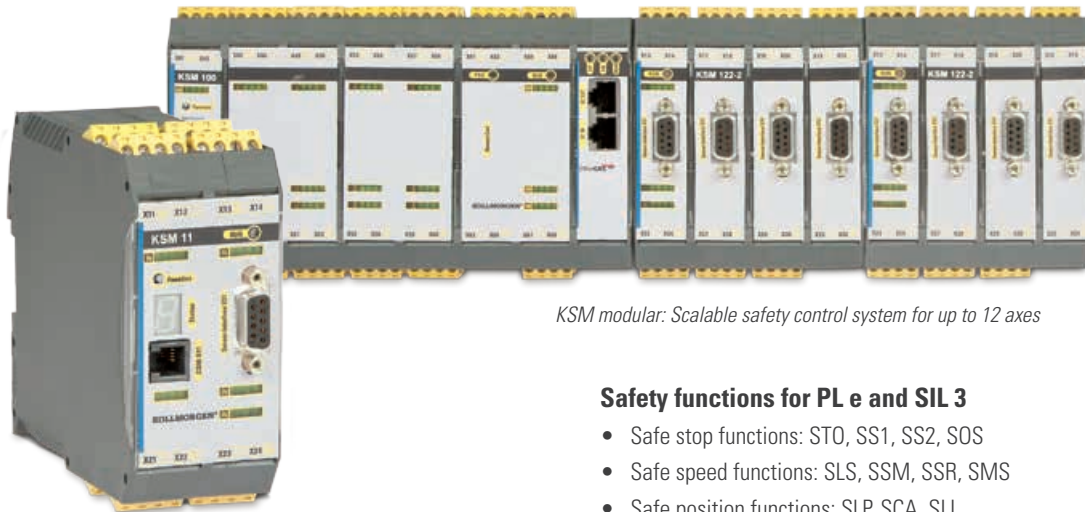

*KSM compact:
single module for up to 2 axes*

KSM modular: Scalable safety control system for up to 12 axes

Safety functions for PL e and SIL 3

- Safe stop functions: STO, SS1, SS2, SOS
- Safe speed functions: SLS, SSM, SSR, SMS
- Safe position functions: SLP, SCA, SLI
- Safe direction functions: SDI
- Safe braking functions: SBC

KSM Compact Safety Control

With KSM compact you can turn a drive into a safe one in next to no time. Important safety and monitoring functions for motion and function blocks for the processing of sensor and actuator signals are already integrated.

- For 1 or 2 axes
- Up to 2 expansion modules
- Basic module with 16 safe inputs/outputs
- Expandable to up to 60 safe inputs/outputs
- 1 safe relay output, expandable
- 2 pulse and 2 message outputs
- Expandable to up to 6 pulse and 6 message outputs
- Up to 800 function blocks
- Space-saving, compact design

KSM Modular Safety Control System / Safety PLC

KSM modular is designed for drive solutions with complex safety functions and a large number of interfaces. With up to 3000 function blocks, KSM modular offers the functionality of a safety PLC.

- Up to 12 axes
- Up to 8 expansion modules
- Basic module with up to 56 safe inputs/outputs
- Expandable to up to 200 safe inputs/outputs
- 1 safe relay output, expandable
- 2 pulse and up to 10 message outputs
- Expandable to up to 14 pulse and 22 message outputs
- Up to 3000 function blocks
- For applications with many interfaces

AKM[®] Servo Motors

If you require precise position control, Kollmorgen's wide range of servo motors is certain to offer you the right solution. Our uniquely broad product range provides maximum flexibility for any application. Irrespective of which combination of motors and amplifiers, cables, control systems, and gearheads you require, all components can be easily and extensively integrated. These best-in-class servo systems can be combined with single-axis or multi-axis drive control systems for a system solutions that's precise, reliable, and durable.

The Advantages of AKM Servo Motors

- | | |
|--|--|
| <ul style="list-style-type: none"> • With the same size, the AKM offers up to 47% more power on the motor shaft than before • Amplifier and motor dimensions reduced • Lower system costs | <ul style="list-style-type: none"> • Optimized AKM and direct drive motor windings for the AKD servo drive |
| <ul style="list-style-type: none"> • Quicker start-up of all servo systems • Immediate and adaptive reaction to dynamic loads optimizes performance within seconds • Precise regulation of all motor types • Compensation for stiff and compatible gearheads and clutches | <ul style="list-style-type: none"> • Start-up of amplifiers with plug-and-play detection for AKM and Cartridge DDR series motors |
| <ul style="list-style-type: none"> • More precise machines due to higher resolution and improved accuracy • With multi-turn absolute encoders: reduced cycle times and lower costs for sensors and cabling through the omission of conventional reference run methods | <ul style="list-style-type: none"> • New, cost-efficient multi-turn feedback option |
| <ul style="list-style-type: none"> • Machine design independent of motor size • Installation of motors in the tightest space | <ul style="list-style-type: none"> • Motors with the highest power densities in the whole industry |
| <ul style="list-style-type: none"> • Over 500,000 standard motor versions available in various mounting, connection, and feedback variants, as well as further options • Our flexible products deliver a perfectly suited solution to your application • Simplifies mechanical modifications and design adjustments or renders them totally superfluous | <ul style="list-style-type: none"> • AKM offers 28 housing and design length combinations, as well as 120 different standard windings for a single motor series |
| <ul style="list-style-type: none"> • AKM Washdown and AKM Washdown Food also offer maximum reliability and a long service life for the most demanding industrial applications | <ul style="list-style-type: none"> • New IP67 option for AKM |

AKM Servo Motors

Don't do things by halves! With AKM servo motors you build drives that set benchmarks. With the extraordinarily wide range of equipment options, as well as peak values in terms of cogging, dielectric strength, and power loss, you can configure the best possible drive for your machine from the AKM construction kit, without compromising on performance data. Best-in-class components and constant quality control during production guarantee a maximum degree of reliability and a long service life.

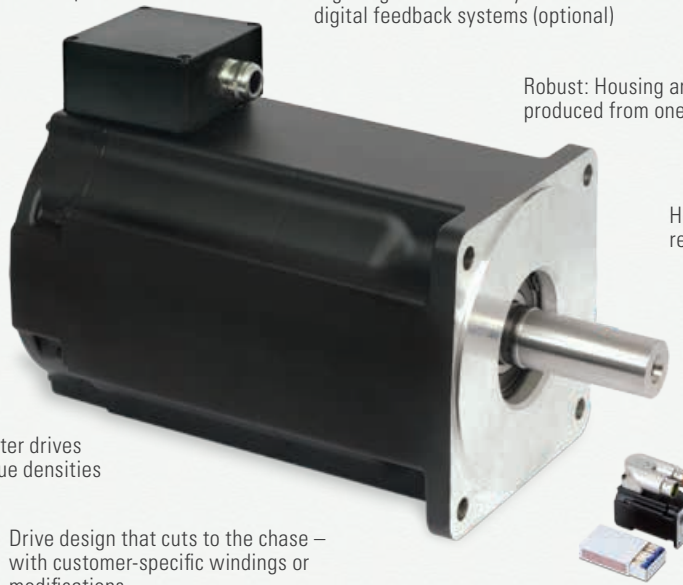

Numerous feedback options such as the SFD digital resolver, single-turn and multi-turn absolute encoders

Numerous connection options

High degree of accuracy thanks to digital feedback systems (optional)

Robust: Housing and front flange produced from one casting

Heavy-duty shaft, optionally with reinforced bearings (only AKM8)

Diversity of options: Over 500,000 possible variants

Smaller and lighter drives due to high torque densities

Drive design that cuts to the chase – with customer-specific windings or modifications.

Small but impressive: AKM1 is one of the smallest servo motors on the market

Worldwide availability and user support through the international Kollmorgen sales and support network

AKM servo motors – the motor construction kit for the perfect drive

- 8 frame sizes from 40 to 260 mm
- 28 housing and design length combinations
- 117 standard windings for 120/240/400/480 V
- Winding option for low DC voltage
- Numerous flange and shaft options
- Minimal cogging and high degree of efficiency
- Extensive customization options with special windings and shafts



Power Range

AKM frame sizes 1 to 8 with standstill torques of 0.16 to 180 Nm, speed range 1000 to 8000 rpm, voltages 75 V DC, 120, 240, 400, 480 V AC.

Application Criteria

Universally deployable, brushless servo motors for all positioning and motion tasks with normal and high requirements and with accuracy and speed in a torque range between 0.16 Nm and 180 Nm.

Feedback Systems and Connectivity

Standard version with two-pin hollow-shaft resolver. Optional SFD3 digital resolver, single or multi-turn absolute encoder with EnDAT, BiSS, or HIPERFACE interfaces. Connection options for single and dual-cable operation, different connector versions, terminal boxes, as well as cable fix-mounted on the motor.

Protection Class

IP65 with optional Teflon shaft seal, IP67 in the Washdown or Washdown Food version (page 51). Standard version IP40.

Smooth Running and Long Service Life

Very smooth running due to minimal cogging. The single-cast stator ensures high stability and improved heat dissipation from the motor. Front flange and motor housing are produced from a single cast. This ensures a high degree of leak-tightness and strength and a long service life.

High Accuracy

AKM Motor		Single-turn absolute			Multi-turn absolute		
		Accuracy (arc-min)	Resolution (bits)	Motor key	Accuracy (arc-min)	Resolution (bits)	Motor key
Value line	AKM1	16	24	C	Change Motion task profile and clear fault with DRV. CLRFAULTS.	Change Motion task profile and clear fault with DRV. CLRFAULTS.	Change Motion task profile and clear fault with DRV. CLRFAULTS.
	AKM2 - AKM3	9	24	C	8	18	LB
	AKM4 - AKM8	9	24	C	4.66	18	LB
Performance line	AKM1	7.2	9	GC	7.2	9	GD
	AKM2 - AKM4	1.0	20	DA	1.0	20	DB
	AKM5 - AKM8	0.333	20	DA	0.333	20	DB

The AKM1 – one of the smallest servo motors on the market offers outstanding power density despite its compact design

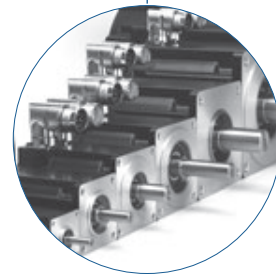
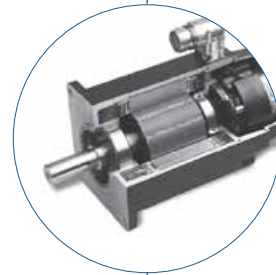

AKM Washdown and Washdown Food

Servo Motors Suitable for use with Food

More hygienic than standard AKM motors, lighter and more cost-effective than stainless-steel servo motors: In many applications with demanding hygiene requirements the AKM Washdown and Washdown Food versions are good alternatives to costly stainless steel motors or expensive protective enclosures.

Extensive range of options allows up to 150000 variants!

Housing design with rounded edges prevents contamination traps

Dual-component epoxy coating

Protection class IP67 allows for regular wet cleaning

Less weight due to stainless-steel-free housing

Lubricants suitable for use with food and shaft seal as per FDA requirements (Washdown Food)



Washdown Food

Washdown

Shaft with high-quality stainless steel

Chemical-resistant Teflon shaft seal

Specially for applications with demanding hygiene requirements in the

- Packaging industry
- Pharmaceutical industry
- Food industry
- Beverage industry
- Laboratory automation
- Medical device technology



Power Range

AKM frame sizes 2 to 6 with standstill torques of 1 to 25 Nm, supply voltages of 75 to 480 V, large selection of different construction lengths, winding variants, as well as feedback systems and connection technologies.

Application Criteria

Designed for environments with acids, bases, or aggressive substances such as frequent cleaning with cleaning agents with pH values of between 2 and 12.

Housing Coating

The coating material of the AKM Washdown motors is resistant to acids and bases and aggressive substances and meets the global migration requirement of the FDA. The rounded and smooth surfaces prevent hazardous contamination traps and germ formation.

Seals and Bearings

Both Washdown versions meet the IP67 protection rating. The proven AKM PTFE shaft seal is used. For the AKM Washdown Food version, the shaft seal meets FDA requirements and only food-safe lubricants are used.

Connectors and Cables

Each in size 1 with special stainless steel design and smooth surface. Cables with special mating connectors are used from stainless steel or a material appropriate for maintaining food quality. The cables are clamped using a special clamping method.

International Standards

UL, CE, FDA*, RoHS

* Global migration requirement

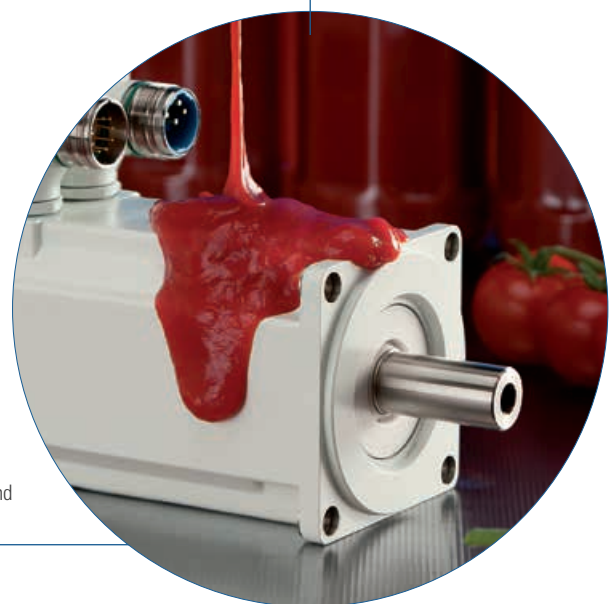

Also proven in harsh environments: The AKM Washdown Food is resistant to most acids and bases, as well as aggressive substances.

AKM Servo Motors

AKM, AKM Washdown, and AKM Washdown Food

Performance Data

AKM type ...	Flange size [mm]	Standstill torque M_0 [Nm]	Standstill current I_0 [A]	Peak torque $M_{p,max}$ [Nm]	75 V DC			115 V			230 V			400 V			480 V			Moment of inertia [kg·cm ²]	Weight [kg]
					Rated speed n_n [min ⁻¹]	Rated torque M_n [Nm]	Rated power P_n [kW]	Rated speed n_n [min ⁻¹]	Rated torque M_n [Nm]	Rated power P_n [kW]	Rated speed n_n [min ⁻¹]	Rated torque M_n [Nm]	Rated power P_n [kW]	Rated speed n_n [min ⁻¹]	Rated torque M_n [Nm]	Rated power P_n [kW]	Rated speed n_n [min ⁻¹]	Rated torque M_n [Nm]	Rated power P_n [kW]		
11B	40	0.18	1.16	0.61	–	–	–	4000	0.18	0.08	8000	0.17	0.14	–	–	–	–	–	–	0.017	0.35
11C	40	0.18	1.45	0.61	–	–	–	6000	0.18	0.11	–	–	–	–	–	–	–	–	–	0.017	0.35
11E	40	0.18	2.91	0.61	6000	0.18	0.11	–	–	–	–	–	–	–	–	–	–	–	–	0.017	0.35
12C	40	0.31	1.51	1.08	–	–	–	4000	0.30	0.13	8000	0.28	0.23	–	–	–	–	–	–	0.031	0.49
12E	40	0.31	2.72	1.08	3000	0.31	0.10	8000	0.28	0.23	–	–	–	–	–	–	–	–	–	0.031	0.49
13C	40	0.41	1.48	1.46	–	–	–	3000	0.41	0.13	8000	0.36	0.30	–	–	–	–	–	–	0.045	0.63
13D	40	0.40	2.40	1.44	2000	0.40	0.08	7000	0.36	0.27	–	–	–	–	–	–	–	–	–	0.045	0.63
21C	60	0.48	1.58	1.47	–	–	–	2500	0.46	0.12	8000	0.39	0.32	–	–	–	–	–	–	0.11	0.82
21E	60	0.50	3.11	1.49	2000	0.48	0.10	7000	0.41	0.30	–	–	–	–	–	–	–	–	–	0.11	0.82
21G	60	0.50	4.87	1.51	4000	0.46	0.19	–	–	–	–	–	–	–	–	–	–	–	–	0.11	0.82
22C	60	0.84	1.39	2.73	–	–	–	1000	0.83	0.09	3500	0.78	0.29	8000	0.68	0.57	8000	0.68	0.57	0.16	1.10
22E	60	0.87	2.73	2.76	1000	0.85	0.09	3500	0.81	0.30	8000	0.70	0.59	–	–	–	–	–	–	0.16	1.10
22G	60	0.88	4.82	2.79	2500	0.83	0.22	7000	0.74	0.54	–	–	–	–	–	–	–	–	–	0.16	1.10
23C	60	1.13	1.41	3.77	–	–	–	1000	1.11	0.12	2500	1.08	0.28	5500	0.99	0.57	7000	0.95	0.70	0.22	1.38
23D	60	1.16	2.19	3.84	–	–	–	1500	1.12	0.18	5000	1.03	0.54	8000	0.92	0.77	8000	0.92	0.77	0.22	1.38
23F	60	1.18	4.31	3.88	1500	1.15	0.18	4500	1.07	0.50	8000	0.94	0.79	–	–	–	–	–	–	0.22	1.38
24C	60	1.38	1.42	4.67	–	–	–	–	–	–	2000	1.32	0.28	4500	1.25	0.59	5500	1.22	0.70	0.27	1.66
24D	60	1.41	2.21	4.76	–	–	–	1500	1.36	0.21	4000	1.29	0.54	8000	1.11	0.93	8000	1.11	0.93	0.27	1.66
24F	60	1.42	3.89	4.82	1000	1.39	0.15	3000	1.33	0.42	8000	1.12	0.94	–	–	–	–	–	–	0.27	1.66
31C	80	1.15	1.37	3.88	–	–	–	–	–	–	2500	1.12	0.29	5000	1.00	0.52	6000	0.91	0.57	0.33	1.55
31E	80	1.20	2.99	4.00	750	1.19	0.09	2500	1.17	0.31	6000	0.95	0.60	–	–	–	–	–	–	0.33	1.55
31H	80	1.23	5.85	4.06	2000	1.20	0.25	6000	0.97	0.61	–	–	–	–	–	–	–	–	–	0.33	1.55
32C	80	2.00	1.44	6.92	–	–	–	–	–	–	1500	1.95	0.31	3000	1.86	0.58	3500	1.83	0.67	0.59	2.23
32D	80	2.04	2.23	7.10	–	–	–	1000	2.00	0.21	2500	1.93	0.51	5500	1.65	0.95	6000	1.58	0.99	0.59	2.23
32E	80	2.04	2.82	7.11	–	–	–	–	–	–	3500	1.87	0.69	7000	1.41	1.03	7000	1.22	1.02	0.59	2.23
32H	80	2.10	5.50	7.26	1200	2.06	0.26	3000	1.96	0.62	7000	1.45	1.06	–	–	–	–	–	–	0.59	2.23
33C	80	2.71	1.47	9.76	–	–	–	–	–	–	1000	2.64	0.28	2000	2.54	0.53	2500	2.50	0.65	0.85	2.9
33E	80	2.79	2.58	9.96	–	–	–	–	–	–	2000	2.62	0.55	4500	2.34	1.10	5000	2.27	1.19	0.85	2.9
33H	80	2.88	5.62	10.22	800	2.82	0.24	2500	2.66	0.70	5500	2.27	1.31	–	–	–	–	–	–	0.85	2.9
41C	90	1.95	1.46	6.12	–	–	–	–	–	–	1200	1.88	0.24	3000	1.77	0.56	3500	1.74	0.64	0.81	2.44
41E	90	2.02	2.85	6.28	–	–	–	1200	1.94	0.24	3000	1.82	0.57	6000	1.58	0.99	6000	1.58	0.99	0.81	2.44
41H	90	2.06	5.6	6.36	1000	1.99	0.21	3000	1.86	0.58	6000	1.62	1.02	–	–	–	–	–	–	0.81	2.44
42C	90	3.35	1.40	11.3	–	–	–	–	–	–	–	–	–	1500	3.10	0.49	2000	3.02	0.63	1.5	3.39
42E	90	3.42	2.74	11.3	–	–	–	–	–	–	1800	3.12	0.59	3500	2.81	2.35	4000	2.72	1.14	1.5	3.39
42G	90	3.53	4.80	11.5	–	–	–	–	–	–	3500	2.90	1.06	6000	2.35	1.48	6000	2.35	1.48	1.5	3.39
42J	90	3.56	8.4	11.6	–	–	–	3000	3.03	0.95	6000	2.36	1.50	–	–	–	–	–	–	1.5	3.39
43E	90	4.70	2.76	15.9	–	–	–	–	–	–	1500	4.24	0.67	2500	3.92	1.03	3000	3.76	1.18	2.1	4.35
43G	90	4.80	4.87	16.1	–	–	–	–	–	–	2500	4.00	1.05	5000	3.01	1.58	6000	2.57	1.61	2.1	4.35
43K	90	4.90	9.60	16.4	–	–	–	2500	4.08	1.07	6000	2.62	1.65	–	–	–	–	–	–	2.1	4.35
44E	90	5.76	2.90	19.9	–	–	–	–	–	–	1200	5.22	0.66	2000	4.80	1.01	2500	4.56	1.19	2.7	5.3
44G	90	5.88	5.00	20.3	–	–	–	–	–	–	2000	4.90	1.03	4000	3.76	1.57	5000	3.19	1.67	2.7	5.3
44J	90	6.00	8.80	20.4	–	–	–	–	–	–	4000	3.84	1.61	6000	2.75	1.73	6000	2.75	1.73	2.7	5.3
51E	115	4.70	2.75	11.6	–	–	–	–	–	–	1200	4.41	0.55	2500	3.98	1.04	3000	3.80	1.19	3.4	4.2
51G	115	4.75	4.84	11.7	–	–	–	–	–	–	2500	4.02	1.05	5000	2.62	1.37	6000	1.94	1.22	3.4	4.2
51H	115	4.79	6.00	11.7	–	–	–	–	–	–	3000	3.87	1.22	6000	1.95	1.23	6000	1.95	1.23	3.4	4.2
51K	115	4.90	9.40	11.9	–	–	–	2500	4.15	1.09	5500	2.35	1.35	–	–	–	–	–	–	3.4	4.2

Performance Data

AKM type ...	Frame size [mm]	Standstill torque M_0 [Nm]	Standstill current I_0 [A]	Peak torque M_{max} [Nm]	230 V			400 V			480 V			Moment of inertia [kg·cm ²]	Weight [kg]
					Rated speed n_n [min ⁻¹]	Rated torque M_n [Nm]	Rated power P_n [kW]	Rated speed n_n [min ⁻¹]	Rated torque M_n [Nm]	Rated power P_n [kW]	Rated speed n_n [min ⁻¹]	Rated torque M_n [Nm]	Rated power P_n [kW]		
52E	115	8.34	2.99	21.3	–	–	–	1500	7.61	1.20	2000	7.28	1.52	6.2	5.8
52G	115	8.43	4.72	21.5	1200	7.69	1.21	2500	7.06	1.85	3000	6.66	2.09	6.2	5.8
52H	115	8.48	5.90	21.6	1800	7.53	1.42	3500	6.26	2.30	4000	5.77	2.42	6.2	5.8
52K	115	8.60	9.30	21.9	3000	6.80	2.14	5500	3.90	2.25	6000	3.25	2.04	6.2	5.8
52M	115	8.60	13.1	21.9	4500	5.20	2.45	–	–	–	–	–	–	6.2	5.8
53G	115	11.4	4.77	29.7	1000	10.7	1.12	2000	9.85	2.06	2400	9.50	2.39	9.1	7.4
53H	115	11.5	6.60	30.0	–	–	–	3000	8.63	2.77	3500	8.23	3.02	9.1	7.4
53K	115	11.6	9.40	30.3	2000	10.1	2.12	4000	7.65	3.20	4500	6.85	3.23	9.1	7.4
53M	115	11.4	13.4	29.7	3000	8.72	2.74	–	–	–	–	–	–	9.1	7.4
53P	115	11.4	19.1	29.8	5000	5.88	3.08	–	–	–	–	–	–	9.1	7.4
54G	115	14.3	5.00	38.0	–	–	–	1500	12.9	2.03	2000	12.3	2.57	12	9
54H	115	14.2	5.50	37.5	–	–	–	1500	12.6	2.38	2000	12.2	2.56	12	9
54K	115	14.4	9.7	38.4	1800	12.7	2.39	3500	10.0	3.68	4000	9.25	3.87	12	9
54L	115	14.1	12.5	37.5	2500	11.5	3.00	4500	8.13	3.83	–	–	–	12	9
54N	115	14.1	17.8	37.6	3500	9.85	3.61	–	–	–	–	–	–	12	9
62G	142	11.9	4.9	29.7	–	–	–	1800	10.4	1.96	2000	10.2	2.14	17	8.9
62K	142	12.2	9.6	30.2	2000	10.4	2.18	3500	9.00	3.30	4500	8.00	3.77	17	8.9
62M	142	12.2	13.4	30.2	3000	9.50	2.98	6000	5.70	3.58	6000	5.70	3.58	17	8.9
62P	142	12.3	18.8	30.3	4500	8.10	3.82	–	–	–	–	–	–	17	8.9
63G	142	16.5	4.5	42.1	–	–	–	1200	14.9	1.87	1500	14.6	2.29	24	11.1
63K	142	16.8	9.9	42.6	1500	14.9	2.34	3000	12.9	4.05	3500	12.0	4.40	24	11.1
63M	142	17.0	13.8	43.0	2000	14.3	2.99	4000	11.3	4.73	4500	10.5	4.95	24	11.1
63N	142	17.0	17.4	43.0	3000	13.0	4.08	5000	9.60	5.03	6000	7.00	4.40	24	11.1
64K	142	20.8	9.2	53.5	1200	18.8	2.36	2000	17.2	3.60	2500	16.3	4.27	32	13.3
64L	142	21.0	12.8	54.1	1500	18.4	2.89	3000	15.6	4.90	3500	14.4	5.28	32	13.3
64P	142	20.4	18.6	52.9	2500	16.0	4.19	4500	11.9	5.62	5500	9.00	5.18	32	13.3
64Q	142	20.0	20.7	53.2	3000	15.3	4.81	5000	10.7	6.45	6000	7.40	4.65	32	13.3
65K	142	24.8	9.8	64.5	1000	22.8	2.39	2000	20.2	4.23	2200	19.7	4.54	40	15.4
65M	142	25.0	13.6	65.2	1500	21.9	3.44	2500	19.2	5.03	3000	18.1	5.69	40	15.4
65N	142	24.3	17.8	63.7	2000	19.8	4.15	3500	16.0	5.86	4000	14.7	6.16	40	15.4
65P	142	24.5	19.8	64.1	2400	19.1	4.8	4000	14.9	6.24	5000	11.6	6.08	40	15.4
72K	180	29.7	9.3	79.4	–	–	–	1500	25.1	3.94	1800	24.0	4.52	65	19.7
72M	180	30.0	13.0	79.8	–	–	–	2000	23.6	4.94	2500	22.1	5.79	65	19.7
72P	180	29.4	18.7	78.5	1800	23.8	4.49	3000	20.1	6.31	3500	18.2	6.67	65	19.7
72Q	180	29.5	23.5	78.4	2000	23.2	4.89	4000	16.3	6.83	4500	14.1	6.65	65	19.7
73M	180	42.0	13.6	112	–	–	–	1500	33.8	5.31	1800	32.1	6.05	92	26.7
73P	180	41.6	19.5	111	1300	34.7	4.72	2400	28.5	7.16	2800	26.3	7.71	92	26.7
73Q	180	41.5	24.5	111	1500	33.4	5.25	3000	25.2	7.92	3500	22	8.07	92	26.7
74L	180	53.0	12.9	143	–	–	–	1200	43.5	5.47	1400	41.5	6.08	120	33.6
74P	180	52.5	18.5	142	–	–	–	1800	39.6	7.46	2000	35.9	7.52	120	33.6
74Q	180	52.2	26.1	141	1300	41.9	5.71	2500	31.5	8.25	3000	27.3	8.58	120	33.6
82T	260	75	48	210	–	–	–	2500	47.5	12.4	3000	38.0	11.9	172	49
83T	260	130	62	456	–	–	–	2200	70.0	16.1	2500	60.0	15.7	334	73
83V	260	130	91	304	–	–	–	3000	65	20.4	–	–	–	334	73
84T	260	180	67	668	–	–	–	1800	105	19.8	2000	93.0	19.5	495	97

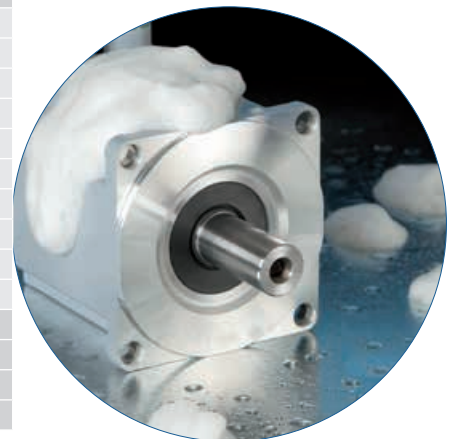
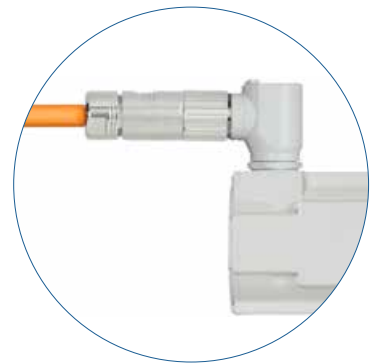
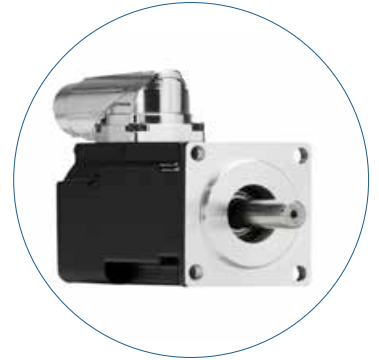

AKM Servo Motors

AKM, AKM Washdown, and AKM Washdown Food

Model with Power and Signal Connector

Dimensional drawing for AKM11 - AKM84

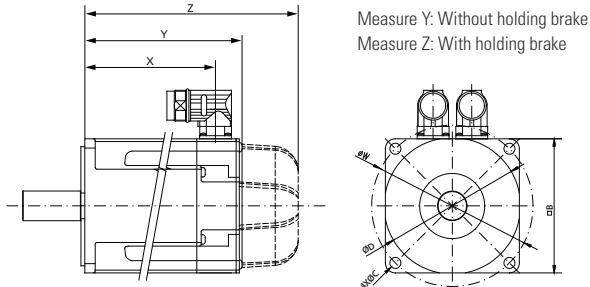

All measurement specifications in mm Measure Y: Measurement without holding brake, Measure Z: Measurement with holding brake

Model	X	Resolvers		Comcoder		Biss/Endat		Hiperface		Flange □B	Bolt circle ØW	Bore diameter ØC	Centering collar ØD
		Y	Z	Y	Z	Y	Z	Y	Z				
AKM11	56.1	69.6	106.6	79.0	—	—	—	79	116	40	46	4.3	30
AKM12	75.1	88.6	125.6	98.0	—	—	—	98	135	40	46	4.3	30
AKM13	94.1	107.6	144.6	117.0	—	—	—	117	154	40	46	4.3	30
AKM21	76.1	95.4	129.5	95.4	129.5	95.4	129.5	113.4	147.1	58	63	4.8	40
AKM22	95.1	114.4	148.5	114.4	148.5	114.4	148.5	132.4	166.1	58	63/65 (1)	4.8	40
AKM23	114.1	133.4	167.5	133.4	167.5	133.4	167.5	151.4	185.1	58	63/65 (1)	4.8	40
AKM24	135.1	152.4	186.5	152.4	186.5	152.4	186.5	170.4	204.1	58	63/65 (1)	4.8	40
AKM31	87.9	109.8	141.3	109.8	141.3	109.8	141.3	125.3	159.3	70	75/85 (2)	5.8	60
AKM32	118.9	140.8	172.3	140.8	172.3	140.8	172.3	156.3	190.3	70	75/85 (2)	5.8	60
AKM33	149.9	171.8	203.3	171.8	203.3	171.8	203.3	187.3	221.3	70	75/85 (2)	5.8	60
AKM41	96.4	118.8	152.3	118.8	152.3	118.8	152.3	136.8	170.3	84	90/100 (3)	7	60/80 (3)
AKM42	125.5	147.8	181.3	147.8	181.3	147.8	181.3	165.8	199.3	84	90/100 (3)	7	60/80 (3)
AKM43	154.4	176.8	210.3	176.8	210.3	176.8	210.3	194.8	228.3	84	90/100 (3)	7	60/80 (3)
AKM44	183.4	205.8	239.3	205.8	239.3	205.8	239.3	223.8	257.3	84	90/100 (3)	7	60/80 (3)
AKM51	105.3	127.5	172.5	127.5	172.5	145.0	189.0	145.0	189.0	108	115/130 (4)	7	95/110 (4)
AKM52	136.3	158.5	203.5	158.5	203.5	177.0	220.0	177.0	220.0	108	115/130 (4)	7	95/110 (4)
AKM53	167.3	189.5	234.5	189.5	234.5	208.0	251.0	208.0	251.0	108	115/130 (4)	7	95/110 (4)
AKM54	198.3	220.5	265.5	220.5	265.5	239.0	282.0	239.0	282.0	108	115/130 (4)	7	95/110 (4)
AKM62	130.5	153.7	200.7	153.7	200.7	172.2	219.7	172.2	219.7	138	165	11	130
AKM63	155.5	178.7	225.7	178.7	225.7	197.2	244.7	197.2	244.7	138	165	11	130
AKM64	180.5	203.7	250.7	203.7	250.7	222.2	269.7	222.2	269.7	138	165	11	130
AKM65	205.5	228.7	275.7	228.7	275.7	247.2	294.7	247.2	294.7	138	165	11	130
AKM72	164.5	192.5	234.5	192.5	234.5	192.5	234.5	192.5	234.5	188	215	13.5	180
AKM73	198.5	226.5	268.5	226.5	268.5	235.7	287.3	235.7	287.3	188	215	13.5	180
AKM74	232.5	260.5	302.5	260.5	302.5	269.7	321.3	269.7	321.3	188	215	13.5	180
AKM82	170	267	333	267	333	267	333	267	333	260	300	18.5	250
AKM83	250.5	347.5	413.5	347.5	413.5	347.5	413.5	347.5	413.5	260	300	18.5	250
AKM84	331	428	494	428	494	428	494	428	494	260	300	18.5	250

(1) ØW = 63 mm AKM2xx-Ax
ØW = 65 mm AKM2xx-Dx

(2) ØW = 75 mm AKM3xx-Ax
ØW = 85 mm AKM3xx-Cx

(3) ØW = 100 mm, ØV = 80 mm AKM4xx-Ax
ØW = 90 mm, ØV = 60 mm AKM4xx-Cx

(4) ØW = 130 mm ØV = 110 mm AKM5xx-Ax
ØW = 115 mm ØV = 95 mm AKM5xx-Ax

The Design Features of AKM in the 3D Model

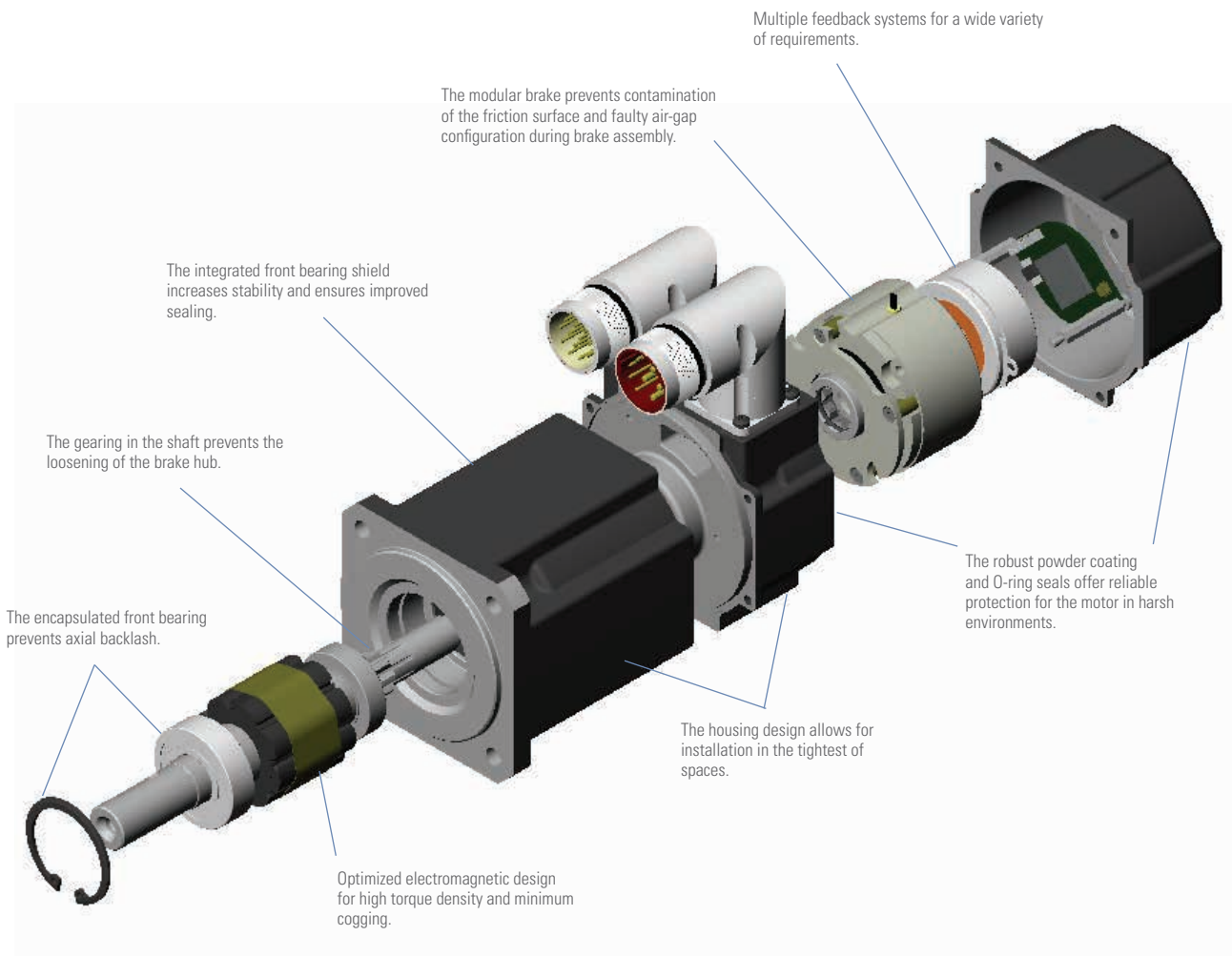

AKM Hygienic Servo Motors

Hygienic Motor-Gearhead Combinations

With the AKM gearhead motors in the Washdown, Washdown Food, and Hygienic versions, Kollmorgen have succeeded in implementing most transport and turning applications in the food and beverage industries as well as downstream packaging with standardized drive solutions. The combination of an AKM servo motor and efficiency-optimized gearheads are the foundation for this.

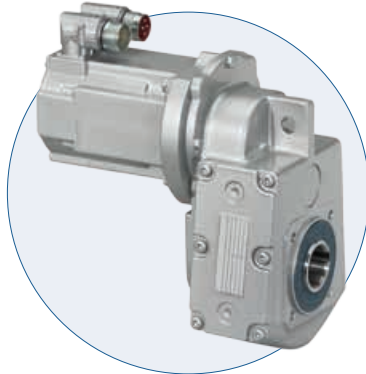

AKM41E-BF06

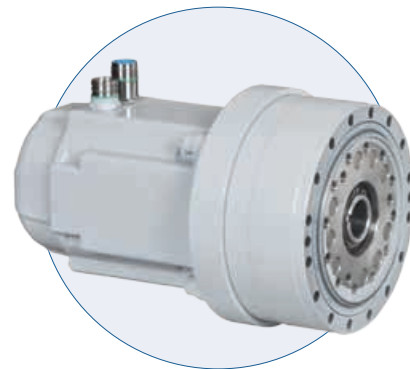

AKM62L-F2CS-A35-59

Type		AKM41E-BF06	AKM62L-F2CS-A35-59
Version		Washdown, coated	Washdown, coated
Rated output torque	Nm	51	668
Fatigue-endurable acceleration torque	Nm	76	1390
Medium output speed	min ⁻¹	75	28
Maximum output speed	min ⁻¹	95	67
Gearhead ratio		31.5	59
Encoder		Resolvers	Resolvers
Special features			Circumferential backlash under 1 arc min, holding brake
Advantages		<ul style="list-style-type: none"> • Developed for regular cleaning with common cleaning agents with pH 2 to pH 12 • Space-saving motor-gearhead technology • Increased service life in harsh environments due to Washdown coating 	<ul style="list-style-type: none"> • High peak power and very low circumferential backlash • Extremely compact design with very high torque • Increased service life in harsh environment conditions due to Washdown coating

A Special Solution Becomes the Standard with Co-Engineering

The main advantages of ready-to-install drive units in a consistent hygienic design: Significantly reduced cleaning times as a consequence of smoother and water-repellent surfaces, lower energy costs thanks to the highly efficient motor-drive combination, and simplified machine design possibilities thanks to space-saving assembly without additional stainless steel housing. By using FDA-compliant materials and thanks to the special, rounded housing design, Kollmorgen's motor-gearhead combinations meet the highest standards in hygiene and reduce the risk of product contamination and recalls.

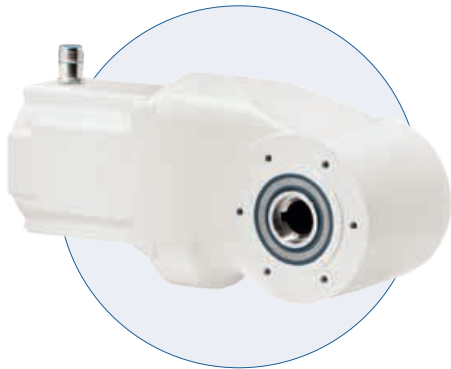

AKM62K-BK17

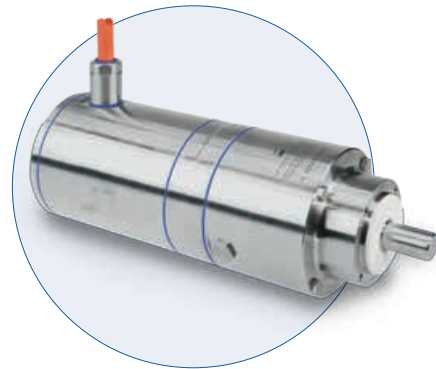

AKMH65M-AQT-160-004

Type		AKM62K-BK17	AKMH65M-AQT160-004
Version		Washdown Food, coated	Hygienic, stainless steel
Rated output torque	Nm	175	64
Fatigue-endurable acceleration torque	Nm	400	876
Medium output speed	min ⁻¹	181	675
Maximum output speed	min ⁻¹	200	1000
Gearhead ratio		19.39	4
Encoder		Resolvers	Digital resolver SFD3, Hiperface DSL
Special features		FDA-compliant coating, lubrication and bearing grease	Circumferential backlash 13 arc mins, single-cable solution
Advantages		<ul style="list-style-type: none"> • Lower energy costs due to high efficiency of servo motors and gearheads • Suitable for indirect contact with food • Simple cleaning thanks to rounded housing design 	<ul style="list-style-type: none"> • Fast cleaning thanks to hygienic design and single-cable solution • Simple start-up due to electronic rating plate • Less risk of food product recalls due to hygienic design

AKMH™

Hygienic Stainless Steel Servo Motors

For more than 70 years, Kollmorgen has been developing special motors for use in difficult environments. For example, the remotely controlled submarine vehicle called the Jason Jr. discovered the wreck of the Titanic with the help of Kollmorgen motors developed especially for this purpose.

Reduced recall risk. In the food production industry extremely strict hygiene regulations apply so that public health is not compromised. The stainless-steel AKMH servo motors meet the most demanding requirements in relation to hygiene standards and reduce the risk of product contamination and costly recalls.

Faster cleaning and reduced maintenance times. The stainless steel AKMH servo motors are designed to protection class IP69K and satisfy the requirements of the EHEDG and 3A hygiene regulations. Only materials are used that are FDA-approved and suitable for use with food. These characteristics of the AKMH series enable quick, hygienic cleaning, reduce maintenance times, and therefore increase the overall equipment effectiveness of your production line.

The bottom line. The stainless steel AKMH series of motors has been designed for hygienic machine applications. The large product range with 19 standard motor frame sizes, multiple standard windings, and numerous connection, brake, and cable options makes it easier to choose a motor that satisfies the requirements of the highest standards in the food, beverage, and pharmaceutical industries.

The Advantages of AKMH Hygienic Stainless Steel Servo Motors

Increase in Overall Equipment Effectiveness (OEE)

Faster and environmentally friendly cleaning	<ul style="list-style-type: none"> • Open, hygienic machine design without protective housings • Considerably lower consumption of cleaning agents; less dirty water
No machine downtimes as a result of cleaning or corrosion	<ul style="list-style-type: none"> • Protection class IP69K for motor housing, cable gland, and shaft seal • Designed for regular high-pressure and high-temperature cleaning • Cable and sealing components are resistant to common cleaning agents • No corrosion inside the motor: Pressure compensation through the cable prevents moisture in the motor
Lower operating costs	<ul style="list-style-type: none"> • Higher machine availability due to quicker cleaning • Faster cleaning reduces the consumption of cleaning agents and energy • High energy efficiency due to motor / servo drive combination with a high degree of efficiency
Higher throughput	<ul style="list-style-type: none"> • Quick and precise drives in combination with the AKD servo drives • Process monitoring and optimization with Kollmorgen's software tools

Lower risk of recalls

Hygiene-optimized housing design	<ul style="list-style-type: none"> • Housing in 1.4404 stainless steel with smooth surface prevents the build-up of pathogens • Fluids drained with vertical installation thanks to convex cover • No contamination trap formations – motor housing without edges and external installation components • No color solutions on the rating plate thanks to laser engraving
Use of approved hygiene components	<ul style="list-style-type: none"> • Bearing lubrication and shaft seals FDA-approved • Observance of the EHEDG and 3A Sanitary Certificate hygiene regulations
Hygienic connection technology	<ul style="list-style-type: none"> • FDA-approved cable option suitable for use with food, with silicone tube sheathing • Low cabling costs due to single-cable technology without cable ducts • Easy cleaning prevents contamination traps in the cabling

Reduced development times and design freedom

Ideal drive design	<ul style="list-style-type: none"> • Large selection of standard motors in practically staggered performance categories • 19 frame sizes, flange and shaft measurements as per IEC and NEMA • Continuous torques up to 22 Nm, peak torques up to 92 Nm • Speeds up to 8000 rpm⁻¹ • SFD3 and Hiperface DSL digital feedback systems • Brake and cable options
Simple start-up and parameterization	<ul style="list-style-type: none"> • Plug-and-play connection with pre-assembled connectable cables, no screw connections • Simple machine architecture due to single-cable and decentralized connection technology • Digital rating plate for quick start-up • Software tools for parameterization and drive monitoring
Low energy consumption	<ul style="list-style-type: none"> • High efficiency due to permanent magnet technology • 20% less derating due to special motor design
Kollmorgen development support	<ul style="list-style-type: none"> • Comprehensive consulting by the Kollmorgen support team
Co-engineering	<ul style="list-style-type: none"> • Development of special drive solutions in cooperation with the customer or in a customer order

AKMH Hygienic Stainless Steel Servo Motors

AKMH HYGIENIC STAINLESS STEEL SERVO MOTORS

The new stainless steel AKMH motors have been designed for hygienic machine applications in wet areas with food contact in accordance with the EHEDG regulations and they comply with 3A, USDA* and NFS hygiene standards. Short cleaning times and the high degree of reliability due to special design measures ensure noticeably greater overall equipment effectiveness.

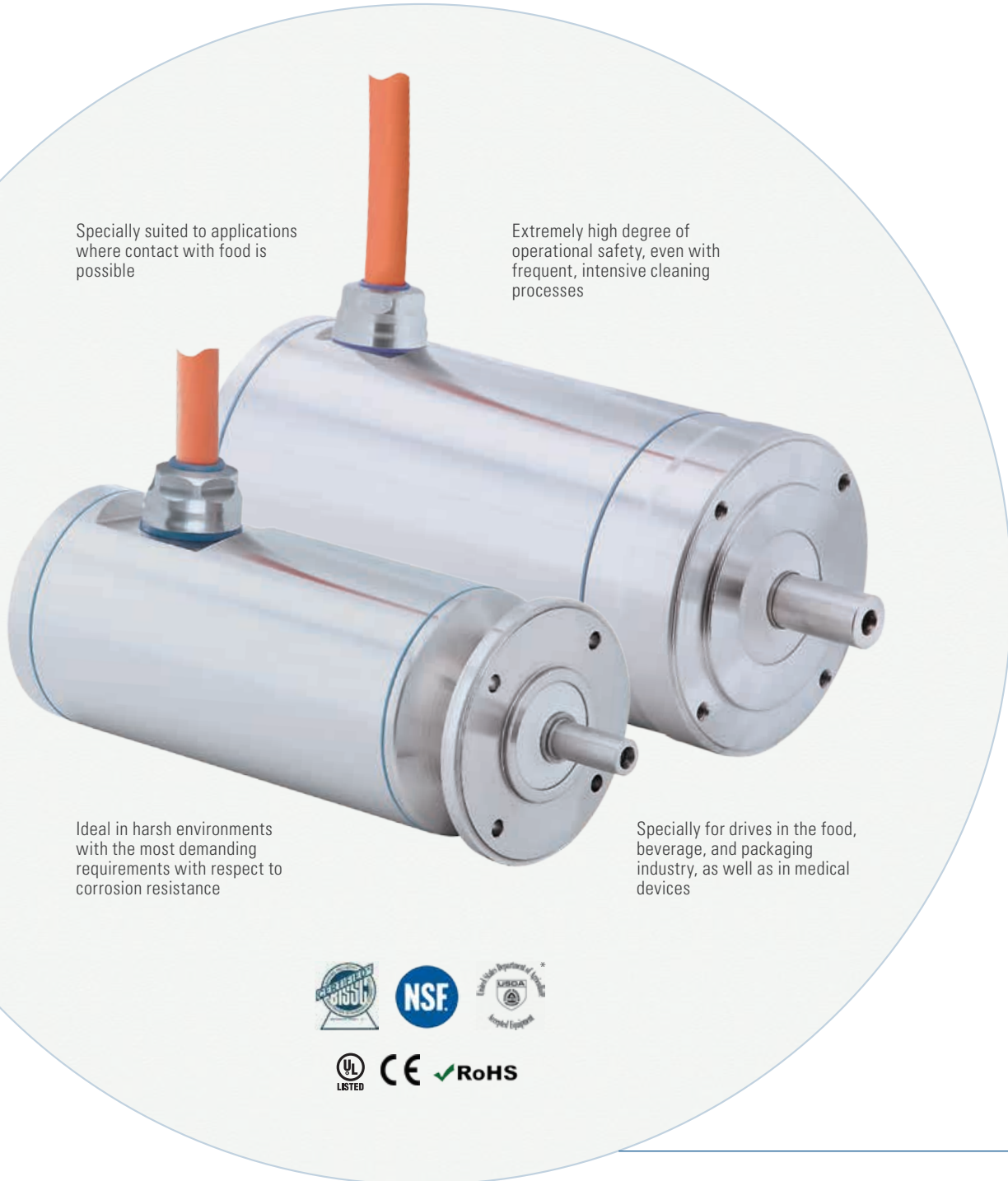

Specially suited to applications where contact with food is possible

Extremely high degree of operational safety, even with frequent, intensive cleaning processes

Ideal in harsh environments with the most demanding requirements with respect to corrosion resistance

Specially for drives in the food, beverage, and packaging industry, as well as in medical devices



* In preparation

Higher Productivity Due to Quicker Cleaning

- Ideal for machines with an open design
- No costly protective equipment; no hard-to-reach contamination traps
- Quick, easy, yet safe cleaning

Reduced Recall Risk

- Lubricants and seals meet FDA standards.
- Round, stainless steel housing with a roughness of $< 0.8 \mu\text{m}$ and the design of all edges with radii of R1.5 prevent dirt deposits

High Degree of Operational Safety

- Version in protection class IP69K: Safe with high-pressure cleaning with water pressure up to 100 bar
- No plug connections susceptible to faults thanks to fixed mounted cables
- Single-cable technology with digital feedback (SFD3 or HIPERFACE® DSL digital resolvers)

Outstanding Efficiency Thanks to Novel Motor Design

- Torque derating under 20%
- High speeds of up to 8000 min^{-1} offer more flexibility for gearhead attachment and higher productivity due to higher output speeds with the same torque
- AKMH2 is the most compact hygienic servo motor on the market

Ideal Drive Design Thanks to 19 Frame Sizes

- 5 sizes each with 4 rotor lengths and winding options for perfect adaptation to servo drives
- Two housing shapes for front and flange mounting

One Source for Your Complete Automation Solution

- The Kollmorgen Automation Suite provides all the tools for motion and PLC programming and for drive management in operation
- AKD-PDMM multi-axis controller: The 3-in-1 solution combines servo drive, motion controller, and PLC in one device

Thanks to the open machine design without protective housings, machines can also be cleaned quickly and safely using high-pressure and high-temperature processes.

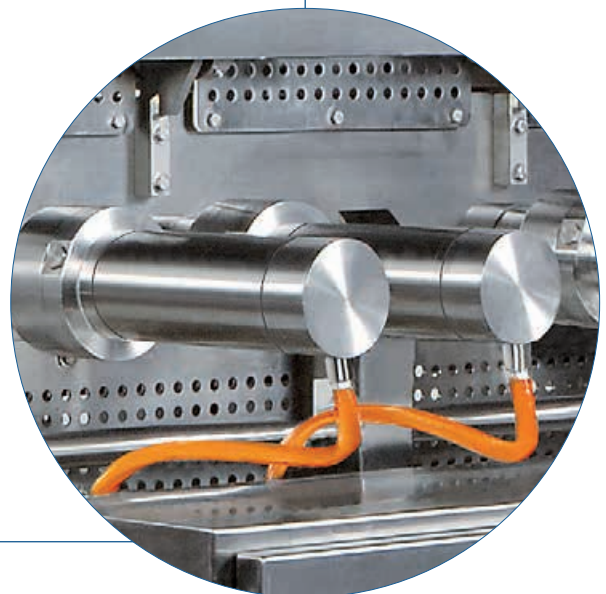
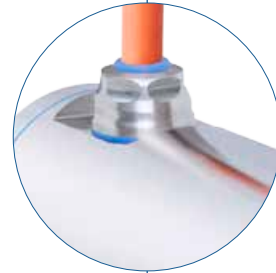

AKMH Hygienic Stainless Steel Servo Motors

The main advantages of the AKMH are:

- Reduced risk of food recalls
- High degree of reliability in all cleaning processes
- Reduced cleaning time: Higher overall equipment effectiveness (OEE)

■ Open machine design without protective housings – quick and safe cleaning

■ The smooth surface meets EHEDG and 3A requirements, promotes rapid cleaning and no harboring of pathogens

■ All exposed surfaces are produced from 1.4404 stainless steel (better hygiene properties and higher corrosion resistance than 1.4301/1.4305 stainless steel)

■ External O-ring and gasket made from FDA-approved materials

■ Chemical-resistant cable for pH values of 2 to 12, complies with IEC 60364-5-52, UL, CSA, CE, RoHS

■ Convex cover for hindering droplet formation, also with vertical assembly

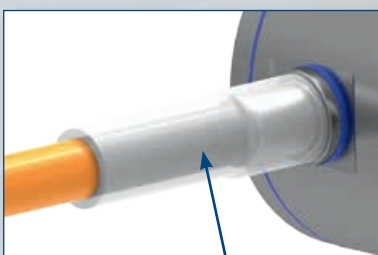

■ FDA-approved sheathing suitable for use with foods

■ No external fixing components (no screws or washers)

Hygienic rating plate for the prevention of contamination trap formation

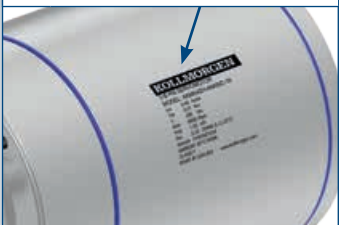

A close-up photograph of a stainless steel motor housing. A blue line highlights a specific area on the housing where a rating plate is attached. The rating plate is a small, rectangular metal plate with text and a barcode. A blue arrow points from the text above to the rating plate.

Unique design technique to eliminate condensation



A diagram showing a cross-section of a motor housing. A blue line highlights a specific design feature on the inner surface of the housing, which is intended to eliminate condensation. A blue arrow points from the text above to this feature.

Single-cable technology for increased reliability, faster cleaning, and fewer places to harbor pathogens

Water-tight cable exit

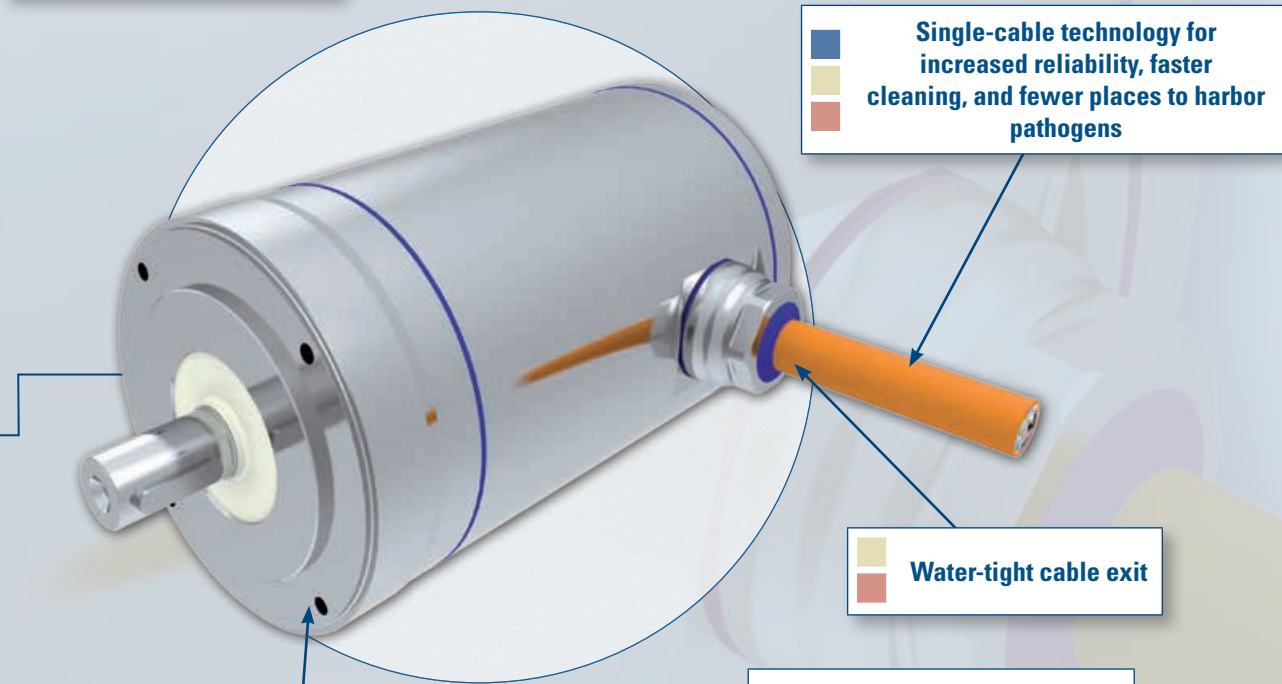

A large central diagram of a stainless steel servo motor. A blue line highlights the single-cable technology, which is a single orange cable that runs through the motor housing. A blue arrow points from the text above to this cable. Another blue arrow points from the text 'Water-tight cable exit' to the point where the cable enters the motor housing.

Effortless assembly thanks to two variants with front or flange installation

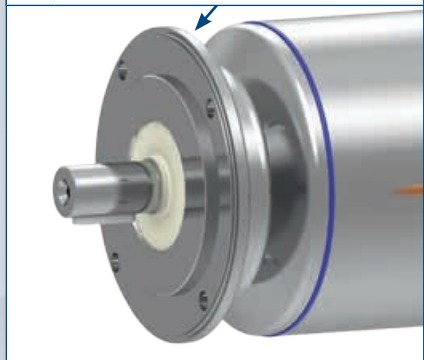

A diagram showing two different ways to install a motor. The first variant shows the motor being installed onto a front flange. The second variant shows the motor being installed onto a side flange. A blue arrow points from the text above to the front flange variant.

Hygienic IP69K shaft seal with long service life

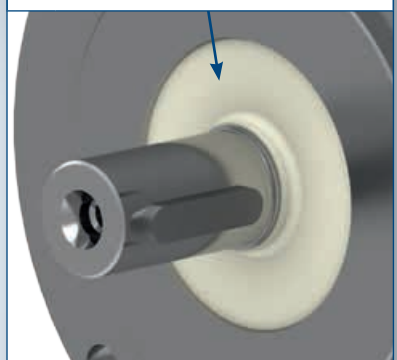

A close-up photograph of a shaft seal on a motor. The seal is a white, circular component that fits around the shaft. A blue arrow points from the text above to the seal.

AKMH Hygienic Stainless Steel Servo Motors

Performance Data

AKMH type ...	Standstill torque M_0 [Nm] ①②③	Standstill current I_0 [A] ①②③	Peak torque $M_{0,max}$ [Nm] ①②③	75 V DC			160 V DC			320 V DC V			560 V DC			640 V DC			Moment of inertia [kg·cm ²]	Weight [kg]
				Rated speed n_n [min ⁻¹]	Rated torque M_n [Nm] ①②③	Rated power P_n [kW] ①②③	Rated speed n_n [min ⁻¹]	Rated torque M_n [Nm] ①②③	Rated power P_n [kW] ①②③	Rated speed n_n [min ⁻¹]	Rated torque M_n [Nm] ②③④	Rated power P_n [kW] ①②③	Rated speed n_n [min ⁻¹]	Rated torque M_n [Nm] ①②③	Rated power P_n [kW] ①②③	Rated speed n_n [min ⁻¹]	Rated torque M_n [Nm] ①②③	Rated power P_n [kW] ①②③		
21C	0.317	1.31	1.57	-	-	-	2500	0.311	0.08	8000	0.255	0.21	8000	0.255	0.21	8000	0.255	0.21	0.107	3.6
21E	0.329	2.56	1.59	2000	0.324	0.068	7000	0.28	0.21	-	-	-	-	-	-	-	-	-	0.107	3.6
21G	0.335	4.04	1.60	4000	0.318	0.13	-	-	-	-	-	-	-	-	-	-	-	-	0.107	3.6
22C	0.633	1.18	3.03	-	-	-	1000	0.627	0.07	3500	0.583	0.21	8000	0.40	0.34	8000	0.40	0.34	0.161	4.1
22E	0.654	2.33	3.07	1000	0.647	0.07	3500	0.601	0.22	8000	0.41	0.35	-	-	-	-	-	-	0.161	4.1
22G	0.661	4.09	3.09	2500	0.632	0.17	7000	0.473	0.35	-	-	-	-	-	-	-	-	-	0.161	4.1
23D	0.897	1.88	4.35	-	-	-	1500	0.881	0.14	5000	0.765	0.40	8000	0.58	0.49	8000	0.58	0.49	0.216	4.6
23E	0.904	2.36	4.37	-	-	-	2500	0.865	0.23	6500	0.688	0.47	-	-	-	-	-	-	0.216	4.6
23F	0.917	3.67	4.41	1500	0.900	0.14	4500	0.806	0.38	8000	0.593	0.50	-	-	-	-	-	-	0.216	4.6
24D	1.12	1.90	5.50	-	-	-	1500	1.11	0.17	4000	1.04	0.44	8000	0.83	0.70	8000	0.83	0.70	0.27	5.1
24E	1.12	2.39	5.51	-	-	-	2000	1.10	0.23	5500	0.98	0.57	-	-	-	-	-	-	0.27	5.1
24F	1.13	3.34	5.53	1000	1.12	0.12	3000	1.09	0.34	8000	0.839	0.70	-	-	-	-	-	-	0.27	5.1
31C	1.00	1.29	4.41	-	-	-	-	-	-	2500	0.95	0.25	5000	0.86	0.45	6000	0.82	0.51	0.33	4.1
31E	1.04	2.76	4.52	750	1.03	0.08	2500	0.96	0.25	6000	0.86	0.54	8000	0.74	0.62	-	-	-	0.33	4.1
31H	1.08	5.51	4.59	2000	1.04	0.22	6000	0.88	0.55	-	-	-	-	-	-	-	-	-	0.33	4.1
32C	1.72	1.30	8.10	-	-	-	-	-	-	1500	1.66	0.26	3000	1.57	0.49	3500	1.52	0.56	0.59	5.0
32E	1.77	2.56	8.24	-	-	-	-	-	-	3500	1.57	0.57	7000	1.10	0.81	8000	0.92	0.77	0.59	5.0
32H	1.82	4.98	8.39	1200	1.78	0.22	3000	1.66	0.52	7000	1.13	0.83	-	-	-	-	-	-	0.59	5.0
33C	2.25	1.27	11.5	-	-	-	-	-	-	1000	2.22	0.23	2000	2.14	0.45	2500	2.09	0.55	0.85	5.9
33E	2.32	2.20	11.7	-	-	-	-	-	-	2000	2.20	0.46	4500	1.82	0.86	5000	1.72	0.90	0.85	5.9
33H	2.38	4.80	11.9	800	2.35	0.20	2500	2.20	0.58	5500	1.64	0.94	8000	0.88	0.74	-	-	-	0.85	5.9
41C	1.85	1.54	6.82	-	-	-	-	-	-	1200	1.78	0.22	3000	1.68	0.53	3500	1.65	0.60	0.81	6.1
41E	1.90	2.89	6.95	-	-	-	1200	1.85	0.23	3000	1.74	0.55	6000	1.44	0.90	6000	1.44	0.90	0.81	6.1
41H	1.94	5.82	7.00	1000	1.89	0.20	3000	1.77	0.56	6000	1.47	0.92	-	-	-	-	-	-	0.81	6.1
42C	3.19	1.42	12.6	-	-	-	-	-	-	-	-	-	1500	2.98	0.47	2000	2.91	0.61	1.45	7.4
42E	3.27	2.77	12.8	-	-	-	-	-	-	1800	2.99	0.56	3500	2.72	1.00	4000	2.62	1.10	1.45	7.4
42H	3.40	6.10	13.1	-	-	-	2000	3.09	0.65	4500	2.63	1.24	6000	2.21	1.39	6000	2.21	1.39	1.45	7.4
42J	3.43	8.56	13.1	-	-	-	3000	2.94	0.92	6000	2.23	1.40	-	-	-	-	-	-	1.45	7.4
43E	4.56	2.79	18.3	-	-	-	-	-	-	1500	4.15	0.65	2500	3.83	1.00	3000	3.68	1.16	2.09	8.8
43H	4.68	5.52	18.7	-	-	-	-	-	-	3000	3.77	1.18	6000	2.44	1.53	6000	2.44	1.53	2.09	8.8
43L	4.59	11.4	18.4	-	-	-	3000	3.69	1.16	6000	2.39	1.50	-	-	-	-	-	-	2.09	8.8
44E	5.64	2.89	23.5	-	-	-	-	-	-	1200	5.13	0.64	2000	4.76	1.00	2500	4.52	1.18	2.73	10.2
44H	5.77	5.68	23.5	-	-	-	-	-	-	2500	4.59	1.20	5000	3.13	1.64	6000	2.58	1.62	2.73	10.2
44K	5.76	10.2	23.5	-	-	-	2000	4.83	1.01	5000	3.10	1.62	6000	2.55	1.60	-	-	-	2.73	10.2
51E	3.3	2.28	15.0	-	-	-	-	-	-	1200	3.11	0.39	2500	2.83	0.74	3000	2.68	0.84	3.42	8.9
51H	3.39	5.02	15.0	-	-	-	-	-	-	3000	2.75	0.86	5500	1.41	0.81	5500	1.41	0.81	3.42	8.9
51L	3.47	10.0	15.2	-	-	-	3000	2.82	0.89	5500	1.45	0.84	-	-	-	-	-	-	3.42	8.9

① Motor winding excess temperature, $\Delta T = 100$ K with ambient temperature = 40°C

② All specifications refer to sinusoidal supply

③ Rated data with reference flange (aluminum, dims (mm): AKMH2, AKMH3, AKMH4: 254 x 254 x 6.35 AKMH5: 305 x 305 x 12.7 AKMH6: 457 x 457 x 12.7)

Performance Data

AKMH type ...	Standstill torque M_0 [Nm] ①②③	Standstill current I_0 [A] ①②③	Peak torque M_{max} [Nm]	75 V DC			160 V DC			320 V DC			560 V DC			640 V DC			Moment of inertia [kg·cm ²]	Weight [kg]
				Rated speed n_n [min ⁻¹]	Rated torque M_n [Nm] ①②③	Rated power P_n [kW] ①②③	Rated speed n_n [min ⁻¹]	Rated torque M_n [Nm] ①②③	Rated power P_n [kW] ①②③	Rated speed n_n [min ⁻¹]	Rated torque M_n [Nm] ①②③	Rated power P_n [kW] ①②③	Rated speed n_n [min ⁻¹]	Rated torque M_n [Nm] ①②③	Rated power P_n [kW] ①②③	Rated speed n_n [min ⁻¹]	Rated torque M_n [Nm] ①②③	Rated power P_n [kW] ①②③		
52E	6.15	2.43	28.9	–	–	–	–	–	–	–	–	1500	5.39	0.85	2000	5.08	1.06	6.22	11.1	
52H	6.29	4.81	29.1	–	–	–	–	–	1800	5.32	1.00	3500	3.44	1.26	4000	2.44	1.02	6.22	11.1	
52L	6.45	9.50	29.5	–	–	–	–	–	3500	3.53	1.29	4500	1.19	0.56	4500	1.19	0.561	6.22	11.1	
52M	6.39	10.7	29.4	–	–	–	–	–	4500	1.18	0.556	–	–	–	–	–	–	6.22	11.1	
53H	8.60	5.29	41.8	–	–	–	–	–	–	–	–	3000	4.06	1.28	3500	2.12	0.78	9.12	13.4	
53L	8.68	9.43	42.0	–	–	–	–	–	3000	4.09	1.28	3500	2.14	0.78	3500	2.14	0.78	9.12	13.4	
53P	8.49	15.2	41.7	–	–	–	–	–	3500	2.09	0.77	–	–	–	–	–	–	9.12	13.4	
54H	10.5	4.35	53.3	–	–	–	–	–	1000	9.31	3.00	1800	7.62	1.44	2000	7.09	1.48	11.92	15.7	
54L	10.4	9.82	53.3	–	–	–	–	–	2500	5.13	1.34	3000	2.47	0.78	–	–	–	11.92	15.7	
54P	10.6	15.3	53.9	–	–	–	–	–	3000	2.52	0.79	–	–	–	–	–	–	11.92	15.7	
62H	10.6	5.3	39.8	–	–	–	–	–	1000	10.5	1.10	1800	9.93	1.87	2000	9.86	2.07	16.9	19.6	
62L	10.8	11.7	40.1	–	–	–	–	–	2500	9.61	2.52	5000	4.95	2.59	5500	3.31	1.91	16.9	19.6	
62M	10.9	13.1	40.2	–	–	–	–	–	3000	9.10	2.86	5500	3.33	1.92	5500	3.33	1.92	16.9	19.6	
63H	14.6	5.2	57.9	–	–	–	–	–	–	–	–	1500	13.6	2.14	1800	13.2	2.49	24.2	23.1	
63L	14.8	10.6	58.4	–	–	–	–	–	1800	13.4	2.53	3000	11.1	3.49	3500	9.60	3.52	24.2	23.1	
63M	15.0	13.0	58.8	–	–	–	–	–	2000	13.3	2.79	4000	7.90	3.31	4500	5.70	2.69	24.2	23.1	
64K	18.7	8.7	75.1	–	–	–	–	–	1200	17.1	2.15	2000	15.6	3.27	2500	14.2	3.72	31.6	26.7	
64L	19.0	12.1	75.6	–	–	–	–	–	1500	16.8	2.64	3000	12.5	3.93	3500	10.0	3.67	31.6	26.7	
64K	21.9	9.1	91.4	–	–	–	–	–	1000	20.2	2.12	2000	17.7	3.71	2500	17.1	3.94	40.0	30.2	
64L	22.2	11.3	92.0	–	–	–	–	–	1300	19.7	2.68	2500	16.0	4.19	2800	14.5	4.25	40.0	30.2	
64M	22.2	12.6	92.0	–	–	–	–	–	1500	19.4	3.44	2700	15.1	4.27	3000	13.5	5.69	40.0	30.2	

① Motor winding excess temperature, $\Delta T = 100$ K with ambient temperature = 40°C

② All specifications refer to sinusoidal supply

③ Rated data with reference flange (aluminum, dims (mm): AKMH2, AKMH3, AKMH4: 254 x 254 x 6.35 AKMH5: 305 x 305 x 12.7 AKMH6: 457 x 457 x 12.7)

Flange / Shaft Combinations

Type	AC	AN	BK	BN	CC	CN	DK	DN	GC	GN	HC	HN
Mounting	Flange	Flange	Flange	Flange	Front	Front	Front	Front	Flange	Flange	Front	Front
Standard	IEC	IEC	NEMA	NEMA	IEC	IEC	NEMA	NEMA	IEC	IEC	IEC	IEC
Shaft	Cl. groove	Smooth	Op. groove	Smooth	Cl. groove	Smooth	Op. groove	Smooth	Cl. groove	Smooth	Cl. groove	Smooth
AKMH 2x	●	●	–	●	●	●	–	●	–	–	–	–
AKMH 3x	●	●	–	–	●	●	–	–	–	–	–	–
AKMH 4x	●	●	●	●	●	●	●	●	–	–	–	–
AKMH 5x	●	●	●	●	●	●	●	●	●	●	●	●
AKMH 6x	●	●	–	–	●	●	●	●	–	–	–	–

AKMH Hygienic Stainless Steel Servo Motors

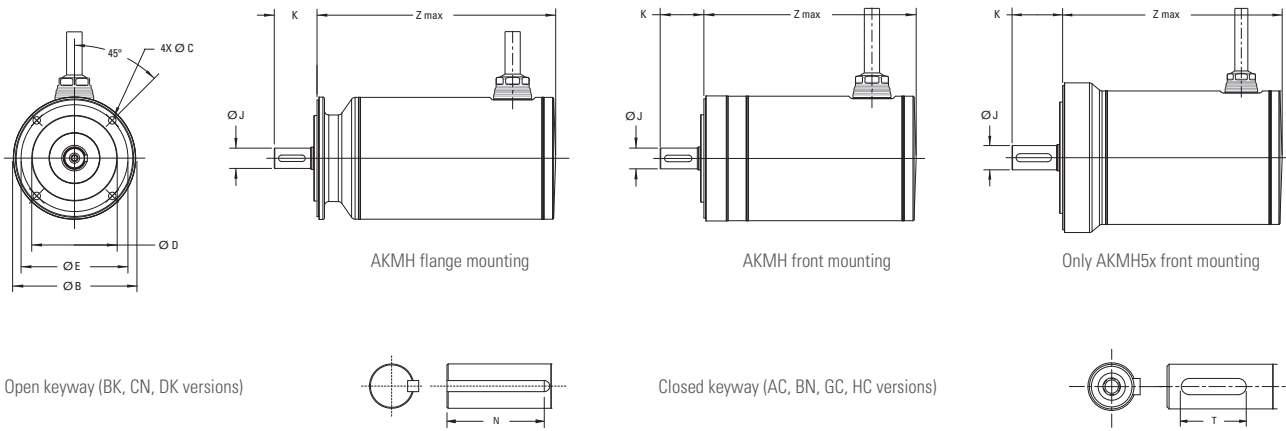

Dimensions (mm)

Model	Z max. SFD3 digital resolver		Z max. Hiperface DSL		Flange
	without brake	with brake	without brake	with brake	ØB
AKMH21	167.2	201.2	180.2	214.2	79
AKMH22	186.2	220.2	199.2	233.2	79
AKMH23	205.2	239.2	218.2	252.2	79
AKMH24	224.2	258.2	237.2	271.2	79
AKMH31	166.5	198.0	182.5	214.0	89
AKMH32	197.5	229.0	213.5	245.0	89
AKMH33	228.5	260.0	244.5	276.0	89
AKMH41	166.7	201.0	182.7	217.0	113
AKMH42	195.7	230.0	211.7	246.0	113
AKMH43	224.7	259.0	240.7	275.0	113
AKMH44	253.7	288.0	269.7	304.0	113
AKMH51	187.4	229.4	198.4	240.4	148
AKMH52	218.4	260.4	229.4	271.4	148
AKMH53	249.4	291.4	260.4	302.4	148
AKMH54	280.4	322.4	291.4	333.4	148
AKMH61	209.9	256.5	220.9	267.5	186
AKMH62	234.9	281.5	245.9	292.5	186
AKMH63	259.9	306.5	270.9	317.5	186
AKMH64	284.9	331.5	295.9	342.5	186

Dimensions (mm)

AKMH XX-	AC	AN	BK	BN	CC	CN	DK	DN	GC	GN	HC	HN
Mounting	Flange		Flange		Front	Front	Front	Front	Flange	Flange	Front	Front
Standard	IEC		NEMA		IEC	IEC	NEMA	NEMA	IEC	IEC	IEC	IEC
Shaft	Cl. groove	Smooth	Op. groove	Smooth	Cl. groove	Smooth	Op. groove	Smooth	Cl. groove	Smooth	Cl. groove	Smooth
AKMH 2x	Ø C	4.80		–	5.10		M4 x 0.7 x 8.0		–	UNF10-32		–
	Ø D	40		–	38.10		40		–	38.1		–
	Ø E	63		–	66.68		63		–	66.68		–
	Ø J	11		–	9.524		11		–	9.524		–
	K	30		–	31.8		30.0		–	31.8		–
	N/T	T = 16	NA	–	NA	T = 16	NA	–	NA	–	–	–
AKMH 3x	Ø C	5.80		–	M5 x 0.8 x 10.0		–	–	–	–	–	–
	Ø D	60		–	60		–	–	–	–	–	–
	Ø E	75		–	75		–	–	–	–	–	–
	Ø J	14		–	14		–	–	–	–	–	–
	K	30		–	30.0		–	–	–	–	–	–
	N/T	T = 16	NA	–	–	T = 16	NA	–	–	–	–	–
AKMH 4x	Ø C	7.0		6.91		M6 x 1 x 12		UNC 1/4 - 20 x 12.3		–	–	–
	Ø D	80		73.025		80		73.025	73	–	–	–
	Ø E	100		98.43		100		98.43		–	–	–
	Ø J	19		15.875		19		15.875		–	–	–
	K	40.0		52.40		40.0		52.40		–	–	–
	N/T	T = 25	NA	N = 34.93	NA	T = 25	NA	N = 34.93	NA	–	–	–
AKMH 5x	Ø C	9		8.33		M8 x 1.25 x 16.0		UNC 3/8 - 16 x 19.05		9	M8 x 1.25 x 16.0	
	Ø D	110		55.560		110		55.563		95	95	
	Ø E	130		125.73		130		125.73		115	115	
	Ø J	24		19.05		24		19.05		24	24	
	K	50.0		57.15		50.0		57.15		50.0	50.0	
	D	T = 36	NA	N = 38.1	NA	T = 36	NA	N = 38.1	NA	T = 36	NA	T = 36
AKMH 6x	Ø C	11.00		–	M10 x 1.5 x 20.0		UNC 3/8 - 16 x 19.05		–	–	–	–
	Ø D	130		–	130		114.3		–	–	–	–
	Ø E	165.0		–	165.0		149.23		–	–	–	–
	Ø J	32		–	32		28.580		–	–	–	–
	K	58		–	58		69.9		–	–	–	–
	D	40	NA	–	–	T = 40	NA	N = 38.10	NA	–	–	–

ERD

Hygienic Stainless Steel Linear Actuators

Reduce cleaning times without compromising on performance and space. Kollmorgen combines a stainless-steel AKMH motor with a linear actuator into a hygienic linear drive that is ready-for-installation: ideal for applications such as lifting units, dosing units or format adjustments in the packaging, food processing, and pharmaceutical industries. Extremely compact linear actuators can be supplied as in-line or reverse units in various motor/spindle combinations.

The Advantages of ERD Stainless Steel Linear Actuators

- | | |
|--|--|
| <ul style="list-style-type: none"> • Substantially improved Overall Equipment Effectiveness (OEE) | <ul style="list-style-type: none"> • Fast cleaning thanks to open machine design without protective housings • High degree of reliability with regular high-pressure and high-temperature cleaning • Higher throughput thanks to quick and precise motion control with AKD • Process monitoring and optimization with Kollmorgen's software tools • 20% less derating due to special motor design |
| <ul style="list-style-type: none"> • High degree of product safety with significantly reduced risk of recalls | <ul style="list-style-type: none"> • Complies with USDA, 3A, NSF hygiene regulations • Hygienic housing design with 1.4404 stainless steel for safe cleaning • Single-cable technology with FDA-approved, sheathing suitable for use with food (optional) |
| <ul style="list-style-type: none"> • Simple machine design and quick start-up | <ul style="list-style-type: none"> • Plug-and-play connection with pre-assembled, connectable cables • Robust version in IP69K with high power density and overload capacity • Control with the AKD, AKD-PDMM, and AKD-N servo drives • Extensive software tools for parameterization and drive monitoring • Simple drive design with the Kollmorgen Automation Suite |

ERD Hygienic Stainless Steel Linear Actuators

Simply More Freedom in Hygienic Machine Design

Four frame sizes with variable feeds up to 600 mm, central or decentralized connection technology, encoder and brake options, as well as seamless integration in all Kollmorgen automation solutions – A wide range of options for building perfectly adapted hygienic linear drives. With Kollmorgen, the machines become even simpler. With the IP69K version you can achieve an open machine construction without protective housings, and with single-cable technology cabling costs are halved. Simple and more freedom!

AKMH hygienic stainless steel motor with FDA-approved bearing lubrication and shaft seal.

Single-cable solution halves cabling costs and simplifies machine design.

Increased reliability due to protection class IP69K.

No condensation inside the motor thanks to an innovative pressure compensation concept.

Improved hygiene: The extremely smooth stainless steel surface prevents germ formation.

Faster cleaning thanks to open machine design without protective housings.

Stainless steel linear actuator in a reverse design

High power density and overload capacity.

Applications:

- Lifting units
- Dosing units
- Format adjustments

Stainless steel linear actuator in an in-line version.

Highest Product Safety and Overall Equipment Effectiveness

- Hygienic housing design prevents germ formation and contamination traps
- Quick and simple cleaning thanks to open machine design without protective housings
- High degree of reliability even with frequent high-pressure and high-temperature cleaning thanks to stainless steel housing in IP69K
- Single-cable connection halves cabling costs and improves hygiene
- High degree of product safety in accordance with USDA, 3A, and NSF requirements ensured

Performance Data

Stainless steel linear actuator		AKMH2/ERD15	AKMH3/EDR20	AKMH4/ERD25	AKMH5/ERD30
Protection class / hygiene standards		IP69k / USDA, 3A, NSF			
Connection technology / servo drive		Single-cable technology / AKD (central) or AKD-N (decentralized)			
Encoder options		Digital resolver SFD3, Hiperface DSL			
Motor diameter	mm	74.0	85.0	113.0	132.0
Actuator diameter	mm	42	52	89	89
Feed (max)	mm	600	600	600	600
Feed speed (max)	mm/s	1016	495	1448	813
Feed force	kN	0.89	2.224	14.679	20.017

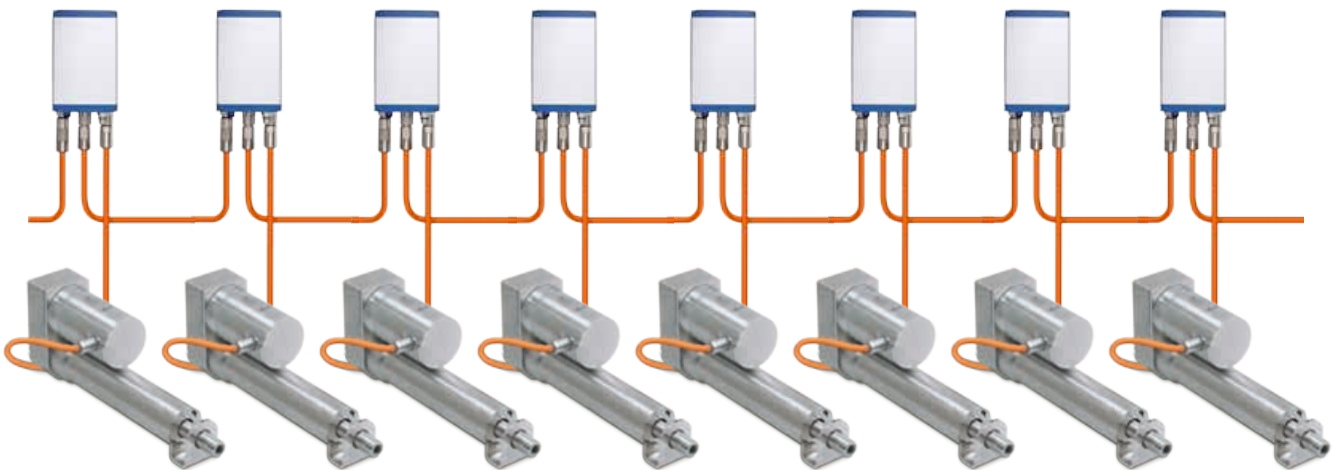

VLM Servo Motors

With the VLM series Kollmorgen offers servo motors with an exceptionally good ratio of torque to costs. The VLM2 and VLM3 model ranges bridge the gap between simple stepper motors, asynchronous motors, and high-performance servo motors.

Fittings and options are designed according to cost efficiency. The VLM servo motors are supplied with fixed mounted cables and connectors. An electronic rating plate is available with the SFD digital resolver option so that the VLM motors are ready for operation the second they are connected.

The AKD or AKD BASIC servo controllers are especially suited for controlling the VLM servo motors. Combined with the AKD PDMM, even applications that require additional control systems or motion control can be executed in an exceptionally cost-effective way without an external PLC.

The Advantages of VLM Servo Motors

- Extraordinary quality and high utility
- Standard configurations for many applications
- Simple assembly and start-up
- Exceptional ratio of Nm per euro
- Proven Kollmorgen-quality components
- No additional cable costs
- Inexpensive feedback options
- Cost-optimized design
- 6 motor sizes and 12 standard windings
- NEMA and metric design
- Cable with open ends and different options for Molex connectors
- Great performance under dynamic loads
- Feedback options – SFD digital resolver, resolver and encoder
- Fixed mounted cables with pre-assembled connectors
- Electronic rating plate with the SFD option
- Control with the AKD servo drives

VLM Servo Motors

Economy Coupled with Power and Functionality

VLM servo motors bridge the performance gaps between simple stepper motors and high-end servo motors. They bring a measurable performance advantage when using high-end servo motors is uneconomical and the use of stepper or asynchronous motors means compromising on the drive's performance specifications.

Quick and simple assembly thanks to fixed cable

Simple connector connection, numerous connector options

Feedback units
SFD digital resolver,
resolver, encoder
hall sensor



Numerous shaft options for universal installation

Ultra strong neodymium magnets ensure high torque



- Exceptional Nm per euro ratio
- Continuous torque 0.5 Nm to 4.5 Nm, peak torque 1.7 Nm to 15.9 Nm
- Speed range up to 6000 min⁻¹
- 2 frame sizes, 6 motor sizes
- Protection class IP40
- Control with the AKD, AKD-BASIC, or AKD-PDMM servo controllers
- Electronic rating plate with optional digital resolver (SFD)
- Satisfies energy efficiency guideline IE4

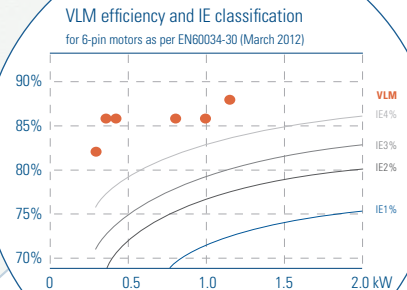

Performance Data

VLM type ...	Frame size NEMA /mm	Standstill torque M_0 [Nm]	Standstill current I_0 [A]	Peak torque M_{peak} [Nm]	75 V DC			160 V			320 V			Moment of inertia [kg·cm ²]	Weight [kg]	Housing □ F	Length Z [mm]
					Rated speed n_n [min ⁻¹]	Rated torque M_n [Nm]	Rated power P_n [kW]	Rated speed n_n [min ⁻¹]	Rated torque M_n [Nm]	Rated power P_n [kW]	Rated speed n_n [min ⁻¹]	Rated torque M_n [Nm]	Rated power P_n [kW]				
21C	60	0.48	1.49	1.66	—	—	—	3500	0.44	0.16	6000	0.41	0.26	0.429	1.4	58	102.4
21E	60	0.47	2.99	1.65	3000	0.44	0.14	6000	0.41	0.26	—	—	—	0.429	1.4	58	102.4
22C	60	0.81	1.69	2.91	—	—	—	2500	0.69	0.18	6000	0.51	0.32	0.633	1.9	58	127.8
22E	60	0.83	3.34	2.94	2000	0.73	0.15	6000	0.52	0.33	—	—	—	0.633	1.9	58	127.8
23D	60	1.18	2.45	4.2	—	—	—	3000	0.94	0.30	6000	0.6	0.38	0.819	2.3	58	153.2
23G	60	1.18	4.91	4.2	2500	1.0	0.35	6000	0.6	0.38	—	—	—	0.819	2.3	58	153.2
31E	90	1.96	2.84	6.4	—	—	—	2000	1.8	0.38	4000	1.63	0.68	1.79	3.0	89	110.5
31H	90	1.95	5.72	6.4	1750	1.82	0.33	4000	1.62	0.68	—	—	—	1.79	3.0	89	110.5
32H	90	3.55	5.26	12.0	—	—	—	2000	3.26	0.68	4500	2.86	1.35	3.37	4.7	89	148.6
32J	90	3.51	8.43	11.9	1500	3.32	0.52	3500	3.0	1.10	—	—	—	3.37	4.7	89	148.6
33J	90	4.53	7.23	15.9	—	—	—	2250	3.93	0.93	5000	2.37	1.24	4.84	6.3	89	186.7

Shaft Connection and Shaft Dimensions (mm)

Type	F	W	C	D	E	F	G
Standard	IEC	NEMA	IEC	NEMA	IEC	NEMA	IEC
Shaft	Height	Smooth	Height	Smooth	Smooth	Flat	Smooth
VLM2xx	ØA	11	9.525	14	6.35	11	9.525
	Length	28.5	20.574	30	20.574	28.5	20.574
VLM3xx	ØA	14	12.7	14	12.7	—	—
	Length	30	31.75	30	31.75	—	—

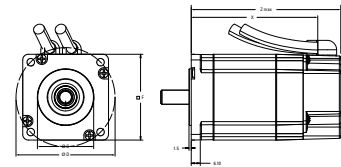

Dimensions (mm)

Model	Standard	Z max.*	X*	Flange	Centering collar	Bolt circle	Bore diameter
				□F	ØC	ØD	ØE
VLM21x - A,C,E,G	IEC	102.4	78.2	58	36.0	70.7	4.5
VLM21x - B,D,F	NEMA	102.4	78.2	58	38.1	66.675	5.08
VLM22x - A,C,E,G	IEC	127.8	103.6	58	36.0	70.7	4.5
VLM22x - B,D,F	NEMA	127.8	103.6	58	38.1	66.675	5.08
VLM23x - A,C,E,G	IEC	153.2	129.0	58	36.0	70.7	4.5
VLM23x - B,D,F	NEMA	153.2	129.0	58	38.1	66.675	5.08
VLM31x - A,C	IEC	112.1	89.4	86	80	100	7
VLM31x - B,D	NEMA	112.1	89.4	86	73.025	98.425	5.537
VLM32x - A,C	IEC	150.2	127.5	86	80	100	7
VLM32x - B,D	NEMA	150.2	127.5	86	73.025	98.425	5.537
VLM3x - A,C	IEC	188.3	165.6	86	80	100	7
VLM33x - B,D	NEMA	188.3	165.6	86	73.025	98.425	5.537

* For versions with the SFD digital resolver option, 12.7 mm longer in each case

Linear Direct Drives

High throughput, high precision, and maintenance-free: Linear direct drives from Kollmorgen set the standard for performance and effectiveness. These are brushless 3-phase servo motors with no housing and an iron core impress due to their high power density and extremely quiet running. The motor design ensures minimum cogging values that result in motion profiles with low fluctuation in terms of power and speed.

The Advantages of Linear Direct Drives

-
- Maintenance-free, greater accuracy and higher bandwidth
 - Even speed profile and low noise development
 - Backlash-free power transmission
 - Power transmission without mechanical components such as couplings, toothed belts, etc.
 - No gearheads, no screws, no lubrication
 - High machine reliability
-
- Large range of motor sizes with various power ranges for universal application in all linear drives
 - Increase in performance of the overall system
 - Compact drive solution with low installation height
 - Can be used with all Kollmorgen motors and servo drives in mixed rotary/linear drives
 - Acceleration of up to 10 G under real-life conditions
-
- Simple design with powerful permanent magnets
 - Higher bandwidth and quicker response than drives with ball screw or toothed belt drives.
 - Quick positioning of heavy loads with peak forces of up to 12700 N
 - Low noise development, fewer parts, and low overall operating costs
 - More compact machine design

ICH Linear Direct Drives

Powerful Precision – As Much As You Want

Increase productivity and reduce operating costs – with the ICH linear motors from Kollmorgen you considerably improve overall equipment effectiveness. Cross the costs for maintenance work out of your calculations! Linear direct drives from Kollmorgen increase throughput compared with other drive systems by up to 40% and enable smaller, lighter machines with high energy efficiency due to their compact design.

ICH Linear Direct Drives

- Maintenance-free iron-core linear motors with high power density
- Direct power transmission without mechanical components
- Special motor design ensures very quiet running
- Feed force of 405 N to 12726 N (peak) and 175 N to 5341 N (continuous operation)
- Optional analog or digital hall effect sensors
- Compatible with all servo drives and safety and energy-saving modules
- Comprehensive development support from the Kollmorgen support team

Wide Range of Speed – from $\mu\text{m/s}$ to km/h

Slower than $1 \mu\text{m/s}$ or faster than 5 m/s – the ICH linear motors from Kollmorgen move the load at all speeds precisely and with extremely low speed variations of $\pm 0.01\%$.

High System Dynamics Over 10 G

ICH linear motors are distinguished by their quick and powerful acceleration. The larger motors typically achieve values between 3 G and 5 G; smaller motors more than 10 G. The primary limiting factor is the machine's management system.

Low Power Fluctuation and High Synchronization

Iron-core linear motors boast high power density, but also a certain degree of cogging depending on the system. The motor design from Kollmorgen reduces cogging to a minimum. The ICH linear motors thus impress with their high power density with low power fluctuation and precise synchronization.

Precise Positioning to Fractions of a μm

Positioning accuracy is limited by the resolution of the feedback system. In combination with the AKD servo drives from Kollmorgen you can develop linear drives that position quickly and precisely.

Unlimited Travel

The secondary parts can be supplied in lengths 64, 128, 256, and 512 mm and can be combined into travel distances as long as you wish.

Simple Drive Design with Few Parts

Drives with linear motors with no housing require fewer parts and are considerably simpler in structure than rotary motors. The ICH linear motors from Kollmorgen merely require an air gap of 0.8 mm – moreover, no critical adjustments are necessary.

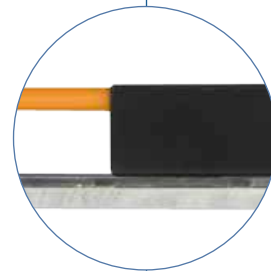
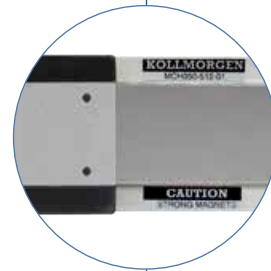
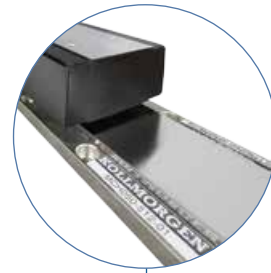

ICH Linear Direct Drives

Feedback System

All brushless motors require a feedback system for the commutation. Kollmorgen offers digital hall effect sensors which are used in the same way as with rotary servo motors from the servo drive to the commutation. In applications with particularly demanding synchronization requirements, digital hall effect sensors are used and the servo drive supplies sinusoidal currents.

For exact position determination, linear encoders – whose signals are simultaneously used for the commutation – are frequently employed. The signals of the hall effect sensors can be used during the start phase in addition to the commutation.

Options

- Hall effect sensors (analog* or digital)
- Thermal overload protection PTC+KTY
- Different cable options

* In development

Applications Lurking Everywhere!

The ICH linear motors can be used in almost all motion tasks in many industries:

- Machine tools:
Tool positioning for drilling, milling, grinding, and laser cutting
- Semi-conductor industry:
Handling, checking and separating wafers, wire bonding, TAB, ion implantation, lithography
- Textile industry:
Tufting machines
- Metrology:
Coordinate measuring devices
- Assembly production:
Placement machinery, screen prints, glue dispensers, drilling and checking printed circuits
- Medical devices:
Patient positioning systems
- Preform injection molding machinery
- Plasma cutting machinery
- Flight simulators
- Acceleration slides, catapults

Functional Principle

Linear motors function according to the same principle as conventional rotary motors. Rotor and stator are rolled out flat and are no longer connected together mechanically. They then form the two components "primary part" (stator, coil part) and "secondary part" (rotor, magnet section). The load is coupled directly to the moving part – usually the primary part – while the secondary part is fixed to the machine as a magnet guide. However, in special applications the primary part may be fixed while the secondary part moves. The functional principle remains the same.

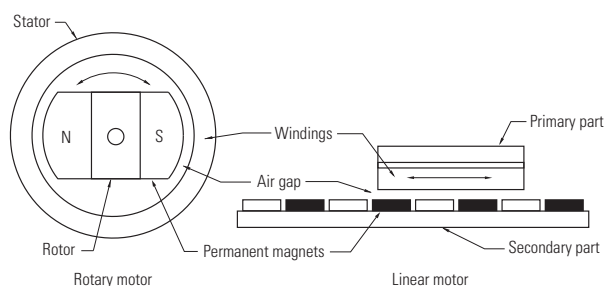

ICH Linear Direct Drives

ICH Series Performance Overview

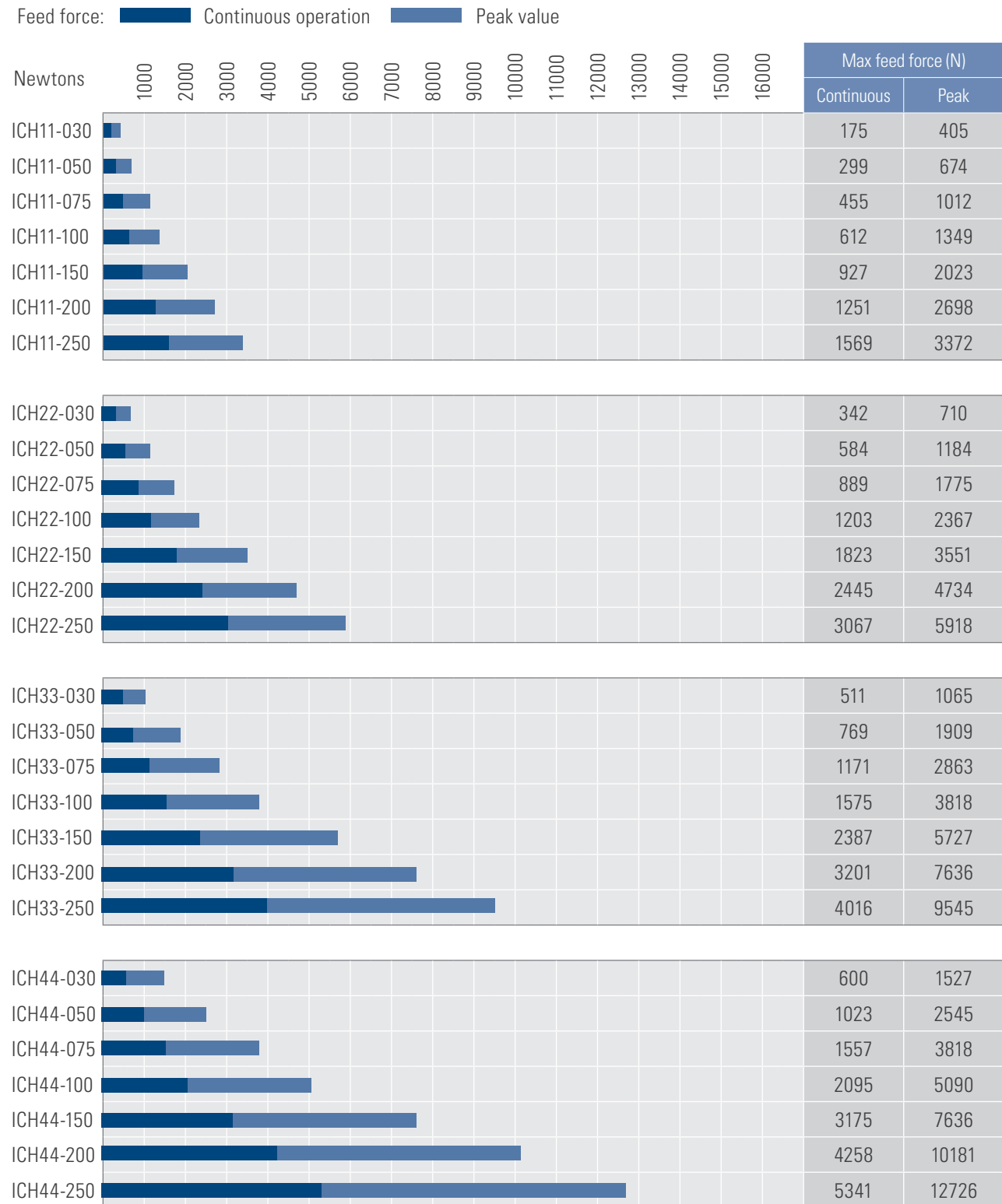

ICH Linear Direct Drives

Iron-core Linear Motors

Performance Data

Model	Winding ²⁾	Feed force [N]		Current [A]		Weight primary part [kg]	Secondary part type	Weight secondary part [kg/m]
		Peak	Continuous ¹⁾	Peak	Continuous			
ICH11-030	A1	405	175	8,9	2,9	2.5	MCH-030	5.4
	A5			15.5	5.0			
ICH11-050	A1	674	299	8,9	2,9	3.5	MCH-050	7.6
	A5			15.5	5.1			
ICH11-075	A1	1012	455	8,9	3,0	4.8	MCH-075	10.4
	A5			15,2	5,2			
ICH11-100	A1	1349	612	8,9	3,0	6.1	MCH-100	13.2
	A5			15,5	5,2			
ICH11-150	A1	2023	927	17,9	6,1	8.6	MCH-150	18.8
	A5			30,9	10,6			
ICH11-200	A1	2698	1251	30,6	10,6	11.2	MCH-200	24.4
	A5			53,0	18,3			
ICH11-250	A1	3372	1569	30,6	10,6	13.8	MCH-250	30.0
	A5			53,0	18,4			
ICH22-030	A1	710	342	8,9	2,8	4.9	MCH-030	5.4
	A5			15,5	4,9			
ICH22-050	A1	1184	584	8,9	2,9	6.8	MCH-050	7.6
	A5			15,5	5,0			
ICH22-075	A1	1775	889	17,9	5,9	9.3	MCH-075	10.4
	A5			30,9	10,2			
ICH22-100	A1	2367	1203	30,6	10,2	11.8	MCH-100	13.2
	A5			53,0	17,0			
ICH22-150	A1	3551	1823	30,6	10,4	16.8	MCH-150	18.8
	A5			53,0	17,9			
ICH22-200	A1	4734	2445	30,6	10,4	21.7	MCH-200	24.4
	A5			53,0	18,0			
ICH22-250	A1	5918	3067	30,6	10,5	26.7	MCH-250	30.0
	A5			53,0	18,1			
ICH33-030	A1	1065	511	8,9	2,8	7.2	MCH-030	5.4
	A5			15,5	4,9			
ICH33-050	A1	1909	769	30,6	8,8	10.2	MCH-050	7.6
	A5			53,0	15,2			
ICH33-075	A1	2863	1171	30,6	8,9	13.8	MCH-075	10.4
	A5			53,0	15,5			
ICH33-100	A1	3818	1575	30,6	9,0	17.5	MCH-100	13.2
	A5			53,0	15,6			
ICH33-150	A1	5727	2387	30,6	9,1	24.9	MCH-150	18.8
	A5			53,0	15,8			
ICH33-200	A1	7636	3201	45,9	13,8	32.2	MCH-200	24.4
	A5			79,5	23,8			
ICH33-250	A1	9545	4016	45,9	13,8	39.6	MCH-250	30.0
	A5			79,5	23,9			
ICH44-030	A1	1527	600	15,3	4,3	9.6	MCH-030	5.4
	A5			26,5	7,4			
ICH44-050	A1	2545	1023	15,3	4,4	13.5	MCH-050	7.6
	A5			26,5	7,6			
ICH44-075	A1	3818	1557	30,6	8,9	18.3	MCH-075	10.4
	A5			53,0	15,4			
ICH44-100	A1	5090	2095	30,6	9,0	23.2	MCH-100	13.2
	A5			53,0	15,6			
ICH44-150	A1	7636	3175	61,2	18,2	33.0	MCH-150	18.8
	A5			106,0	31,5			
ICH44-200	A1	10181	4258	61,2	18,3	42.7	MCH-200	24.4
	A5			106,0	31,7			
ICH44-250	A1	12726	5341	61,2	18,4	52.5	MCH-250	30.0
	A5			106,0	31,8			

1) Continuous feed force with maximum winding temperature 2) Other windings are possible – please ask us about them

ICH Coil Assembly Dimensions

Type	A [mm]	B [mm]	C [mm]
ICHxx-030	60	58.6 ±0.1	16
ICHxx-050	80	58.6 ±0.1	36
ICHxx-075	105	58.6 ±0.1	32
ICHxx-100	130	58.6 ±0.1	36
ICHxx-150	180	60.6 ±0.1	32
ICHxx-200	230	60.6 ±0.1	36
ICHxx-250	280	60.6 ±0.1	32

MCH Magnet Way Dimensions

Type	F [mm]	G [mm]	H [mm]
MCH030-XXX-01	60	10	14.4
MCH050-XXX-01	80	10	14.4
MCH075-XXX-01	105	10	14.4
MCH100-XXX-01	130	10	14.4
MCH150-XXX-01	180	12	16.4
MCH200-XXX-01	230	12	16.4
MXH250-XXX-01	280	14	18.8

Primary Part Length

Type	D [mm]
ICH11-xxx	190
ICH22-xxx	375
ICH33-xxx	542
ICH44-xxx	718

Secondary Part Length

Type	E [mm]
MCHXXX-064-01	64
MCHXXX-128-01	128
MCHXXX-256-01	256
MCHXXX-512-01	512

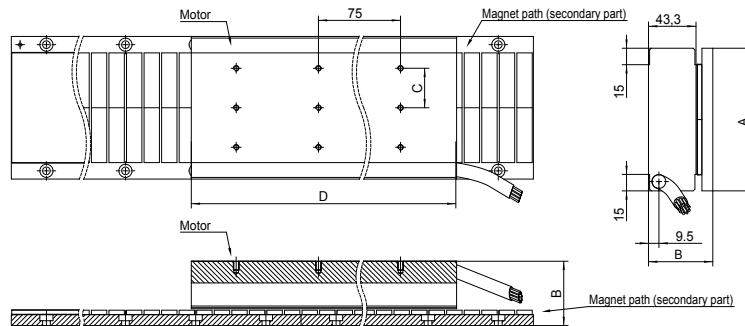

Primary and secondary part assembly

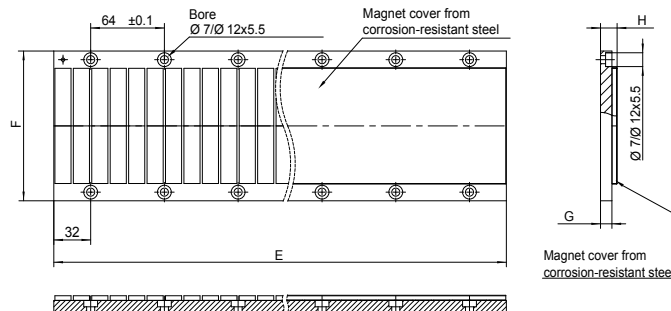

Secondary part per segment

Rotary Direct Drives

Kollmorgen offers a comprehensive selection of direct drives in different sizes and performance ranges. Direct drives are characterized by their high precision, reliability, and above all being maintenance-free. Mechanical components for power transmission such as belts or gearheads are not necessary – you just need the motor and bolts for mounting.

The Cartridge DDR™ (Cartridge Direct Drive Rotary) drives combine the performance advantages of direct drives with no housing with the simple installation and the handling advantages of conventionally housed motors. By contrast the KBM™ series direct drives with no housing can be perfectly tailored to the application thanks to a unique construction kit principle.

All drives can be combined with AKD or ADK PDMM series servo drives, and the powerful Kollmorgen Automation Suite development environment is available for application programming.

Regardless which drive technology you decide on, Kollmorgen provides right solution and optimum support during the development phase.

The Advantages of Rotary Direct Drives

- | | |
|---|--|
| <ul style="list-style-type: none"> • Superb performance data | <ul style="list-style-type: none"> • Maximum torque density thanks to innovative, electromagnetic design minimizes the motor's spatial requirements. • Extremely quiet running with low cogging values and low harmonic distortion (THD) • Wide speed range and high acceleration values |
| <ul style="list-style-type: none"> • Reliable and safe operation through careful construction | <ul style="list-style-type: none"> • Doubly secured magnet mounting on the rotor of the high-speed models through bonding and additional Kevlar® tape overlay • 155°C-approved internal winding temperature and thermistor overtemperature protection guarantee safe continuous operation in demanding applications • Insulation materials with UL approval facilitate the certification of higher-level assemblies • All materials are RoHS-compliant |
| <ul style="list-style-type: none"> • Configurable design reduces the time-to-solution to a minimum | <ul style="list-style-type: none"> • KBM series offers 14 frame sizes with several design lengths • Cartridge DDR series offers 5 frame sizes with several design lengths • Standard sensor feedback with hall effect sensors • Insulation types for high and low voltage • Several winding options with customer-specific windings upon request • Changes to the mechanical connection are easy to perform |

Cartridge DDR Rotary Direct Drives

High Performance in Small Spaces

Less spatial requirements and huge performance benefits: Compared to conventional servo motors, the Cartridge DDR motors offer a power density of up to 50% higher, yet are just as easy to install as housing motors. The rotor of the Cartridge DDR motor rests on the machine's bearings and is connected to the machine shaft through an innovative clamp coupling. Mechanical components for power transmission which limit performance and reliability and increase operating costs are omitted completely.

Up to 50% higher torque density than conventional servo motors

Hollow shaft opening for continuous motor shafts (optional)

Simple attachment with 4 bolts

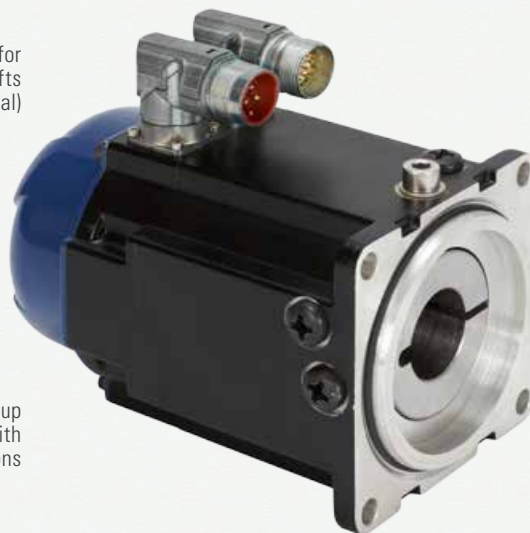

Simple machine shaft connection due to patented clamp coupling

Repeatability improved by up to 60 times compared with motor/gearhead combinations

Installation onto machine flange, no bearings

Advantages of the Cartridge DDR Motors

- Quick assembly within 5 minutes
- Direct power transmission without mechanical components reduces operating and maintenance costs
- Low cogging and thus smooth running at low speeds
- The backlash-free design improves the system's response characteristics

Performance Overview

- 5 frame sizes from 108 to 350 mm
- 17 different lengths and 52 standard windings
- Continuous torques of 4.57 Nm to 510 Nm
- Speeds up to 2500 rpm
- Integrated, high-resolution sinus encoder (optional)

Practical Test: Retrofitting a Roll Feeding Machine with a Cartridge DDR Motor

The Background:

The feed accuracy of a roll feeding machine needs to be improved and the maintenance costs and machine downtimes reduced. A drive solution was sought which enabled higher precision and higher throughput with lower operating and maintenance costs.

The Solution:

The drive solution consisting of motor and gearhead was replaced with a Kollmorgen Cartridge DDR direct drive. Due to the brief installation time and quick start-up, the machine was ready for operation within just a few hours.

The Result:

Significantly improved feed accuracy, considerably higher throughput, substantially lower maintenance costs, greater overall equipment effectiveness. The machine users are pleased with much quieter machinery, the operations managers pleased with disappearing maintenance costs, the production planners pleased with increased machine capacity, and the customers obtain products with better quality thanks to more precise production methods.

The Facts

	Old drive with motor/gearhead combination	Drive with Kollmorgen Cartridge DDR motor	Improvement with the Cartridge DDR motor
Required parts	2 holders 12 screws 2 belt pulleys 2 adjusting screws 2 wedges 1 timing belt 1 clamping system for the belts 1 motor-gearhead combination 1 protective housing	4 bolts 1 Kollmorgen DDR motor CDDR	24 parts vs. 5 parts: 19 fewer parts!
Installation time	4 hours	Approx. 5 mins	3 hours 55 minutes less!
Feed accuracy	±0.005 mm	±0.0013 mm	4 times better feed accuracy!
Throughput	Factor 1	Factor 2	Half the cycle time = double the throughput!
Drive service life	10000 hrs	Almost unlimited because wear-free	No more regular maintenance!
Maintenance work	2000 hrs	None	No more regular maintenance!
Noise development			20 dB lower sound pressure level!

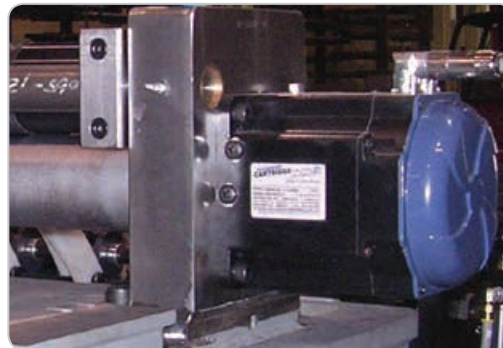

Cartridge DDR Rotary Direct Drives

240 V AC Performance Data

Cartridge drive	Servo drive		Frame size mm	Continuous Torque Nm	Peak Torque Nm	Maximum Speed		Weight kg	Moment of inertia kg·cm ²
	AKD	S700				rpm ⁻¹			
C041A	P00306	S703	108	4.57	12.3	1750		4.08	5.86
C041B	P00606	S706	108	4.52	12.2	2500		4.08	5.86
C042A	P00606	S706	108	8.25	22.2	1700		5.67	8.87
C042B	P01206	S712	108	8.45	22.8	2500		5.67	8.87
C043A	P00606	S706	108	11.1	30.0	1250		7.26	11.9
C043B	P01206	S712	108	11.2	30.2	2500		7.26	11.9
C044A	P00606	S706	108	13.9	37.4	1050		8.84	14.9
C044B	P01206	S712	108	14.1	37.9	2150		8.84	14.9
C051A	P00606	S706	138	11.7	30.2	1200		8.39	27.4
C051B	P01206	S712	138	11.9	30.6	2450		8.39	27.4
C052C	P00606	S706	138	16.9	43.1	950		10.7	35.9
C052D	P01206	S712	138	16.5	42.3	2050		10.7	35.9
C053A	P01206	S712	138	21.0	54.1	1350		13.2	44.3
C053B	P02406	–	138	20.2	50.1	2500		13.2	44.3
C054A	P01206	S712	138	24.9	63.8	1200		15.4	52.8
C054B	P02406	–	138	23.8	61.2	2500		15.4	52.8
C061A	P01206	S712	188	33.8	86.8	900		18.6	94.1
C061B	P02406	–	188	32.6	75.6	1950		18.6	94.1
C062C	P01206	S712	188	48.4	117	700		23.6	126
C062B	P02406	–	188	44.6	102	1400		23.6	126
C063C	P01206	S712	188	61.8	157	550		29.0	157
C063B	P02406	–	188	59.0	136	1050		29.0	157
C091A	P02406	S712	246	50.2	120	600		27.7	280
C092C	P02406	–	246	102	231	450		41.3	470
C093C	P02406	–	246	139	317	350		54.4	660
C131C	P02406	–	350	189	395	250		63.5	1240
C131B	P04806	–	350	190	396	450		63.5	1240
C132C	P02406	–	350	362	818	120		101	2250
C132B	P04806	–	350	361	759	225		101	2250
C133C	P02406	–	350	499	1070	100		132	3020
C133B	P04806	–	350	510	1090	175		132	3020

– It is also referred to as Commutation Alignment and Pole Locking.

400/480 V AC Performance Data

Cartridge drive	Servo drive		Frame size mm	Continuous Torque Nm	Peak Torque Nm	Maximum Speed		Weight kg	Moment of inertia kg·cm ²
	AKD	S700				rpm ⁻¹			
						400 V AC	480 V AC		
CH041A	P00307	S703	108	4.56	11.3	2500	2500	4.08	5.86
CH042A	P00607	S706	108	8.26	19.0	2500	2500	5.67	8.87
CH043A	P00607	S706	108	11.1	25.3	2250	2500	7.26	11.9
CH044A	P00607	S706	108	13.9	31.6	1850	2250	8.84	14.9
CH051A	P00607	S706	138	11.7	28.0	2100	2500	8.39	27.4
CH052C	P00607	S706	138	16.9	43.1	1750	2100	10.7	35.9
CH053A	P01207	S712	138	21.0	54.1	2350	2500	13.2	44.3
CH054A	P01207	S712	138	24.9	63.8	2100	2500	15.4	52.8
CH061A	P01207	S712	188	33.8	86.8	1600	1900	18.6	94.1
CH062C	P01207	S712	188	48.4	117	1250	1550	23.6	126
CH063C	P01207	S712	188	61.8	157	950	1150	29.0	157
CH063B	P02407	S724	188	59.0	136	1850	2200	29.0	157
CH091A	P02407	S712	246	50.2	120	1200	1500	27.7	280
CH092C	P02407	S724	246	102	231	800	1000	41.3	470
CH093C	P02407	S724	246	139	317	700	800	54.4	660
CH131C	P02407	S724	350	189	395	500	600	63.5	1240
CH131B	P04807	S748	350	190	396	800	1000	63.5	1240
CH132C	P02407	S724	350	362	818	250	300	101	2250
CH132B	P04807	S748	350	361	759	400	500	101	2250
CH133C	P02407	S724	350	499	1070	200	250	132	3020
CH133B	P04807	S748	350	510	1090	350	400	132	3020

Cartridge DDR C04, C05, and C06 – Dimensions

Cartridge drive	A mm	B mm	C mm	D mm
C(H)041	171	108	59	93
C(H)042	202	108	59	93
C(H)043	233	108	59	93
C(H)044	264	108	59	93
C(H)051	195	138	76	108
C(H)052	220	138	76	108
C(H)053	245	138	76	108
C(H)054	270	138	76	108
C(H)061	226	188	99	133
C(H)062	260	188	99	133
C(H)063	294	188	99	133

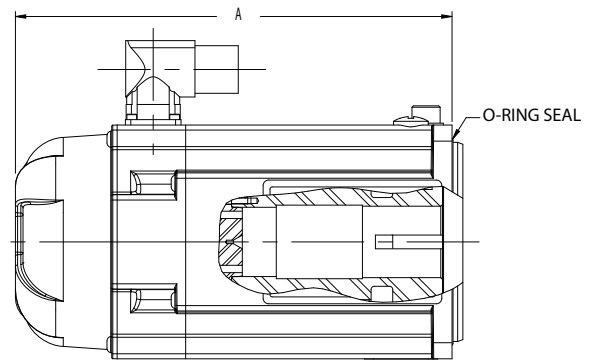
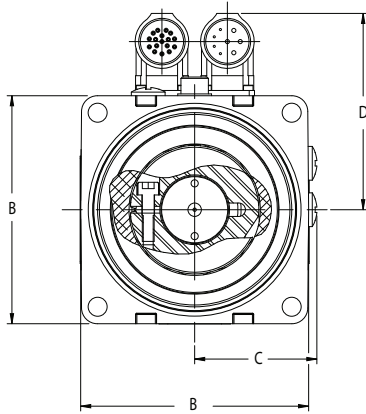
Cartridge DDR C09 and C13 – Dimensions

Cartridge drive	A mm	B mm	C mm	D mm
C(H)091	204	246	149	182
C(H)092	253	246	149	182
C(H)093	302	246	149	182
C(H)131	231	350	200	256
C(H)132	301	350	200	256
C(H)133	370	350	200	256

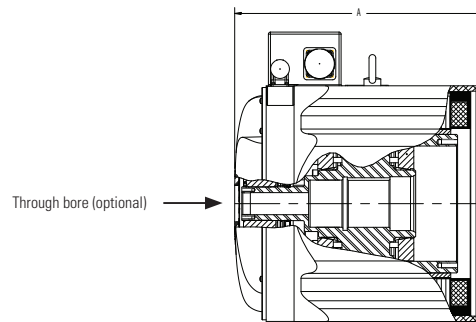
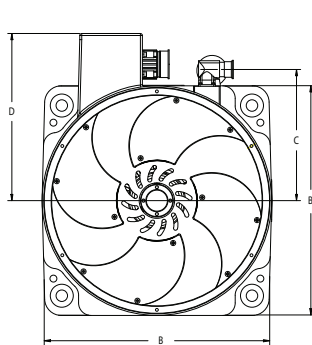

KBM Frameless Direct Drives

The Most Flexible Way to Build Drives

The KBM direct drives with no housing offer the greatest possible flexibility for drive solutions with torque motors. These kit motors are connected to the machine shaft directly and do not require any additional mechanical components for power transmission. They meet especially high demands in relation to performance data, durability, and simple installation.



Features

- Fully encapsulated stator winding
- Designed for continuous winding temperature of 155°C
- PTC thermistor for overload protection
- Magnet material - rare earth neodymium-iron-boron
- Protective tape overlay of the rotor magnets*
- RoHS-compatible

* Not with KBM 163 and KBM 260

Option KBM with Hall Sensors (KBMS)

Version with factory-preset hall sensors mounted on the front of the stator. The rotor length of the KBMS models is extended axially to ensure safe triggering.

Modifications

Kollmorgen offers a range of standard modifications for perfect tailoring of the KBM(S) motors to your specifications. Our engineering team will be happy to advise you and will prepare a proposal based on your specifications.

Different Winding Types

The motor windings can be optimized so that the desired performance data for speed and torque can be achieved at a given operating voltage and a specified current consumption.

Rotor Hub Dimensions

Rotor hubs can be offered with different customer-specific hole patterns, fastening options, or smaller internal bore diameters. The technical data specifies the largest bore diameter available in each case.

Rotor Hub Design

In the standard version the rotor hubs of KBM(S) motors are produced from uncoated, cold-rolled steel. Other versions such as coated, painted, cleaned version or versions made from another material, are possible. Please contact us.

Stator Sheathing Design

In the standard version, the KBM(S) motors 10, 14, 17, 25, 35, 45, 163, and 260 are equipped with a stator sheathing made from uncoated aluminum. Other versions with painted or coated aluminum are possible. Please inquire. However, the stator sheathings can only be supplied for the motor sizes listed above.

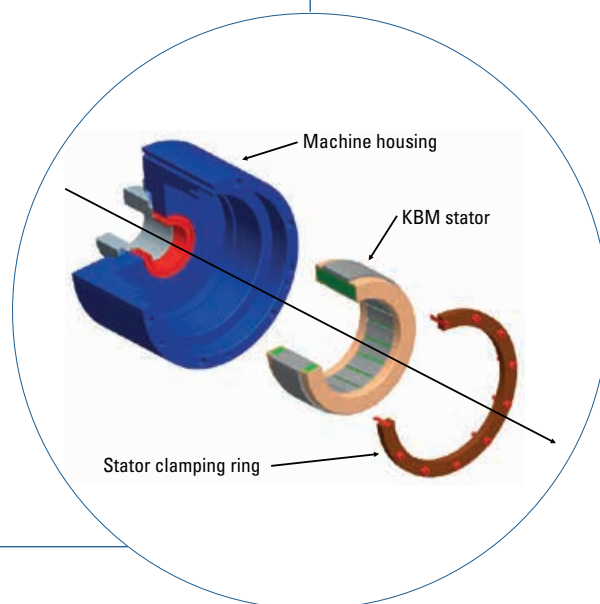
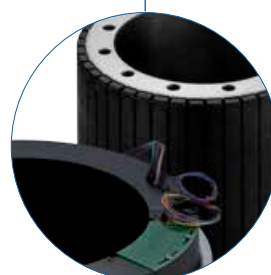

KBM Frameless Direct Drives

Performance Overview

00 Stack 01 Stack 02 Stack 03 Stack 04 Stack 05 Stack

Continuous Standstill Torque Tc in Nm

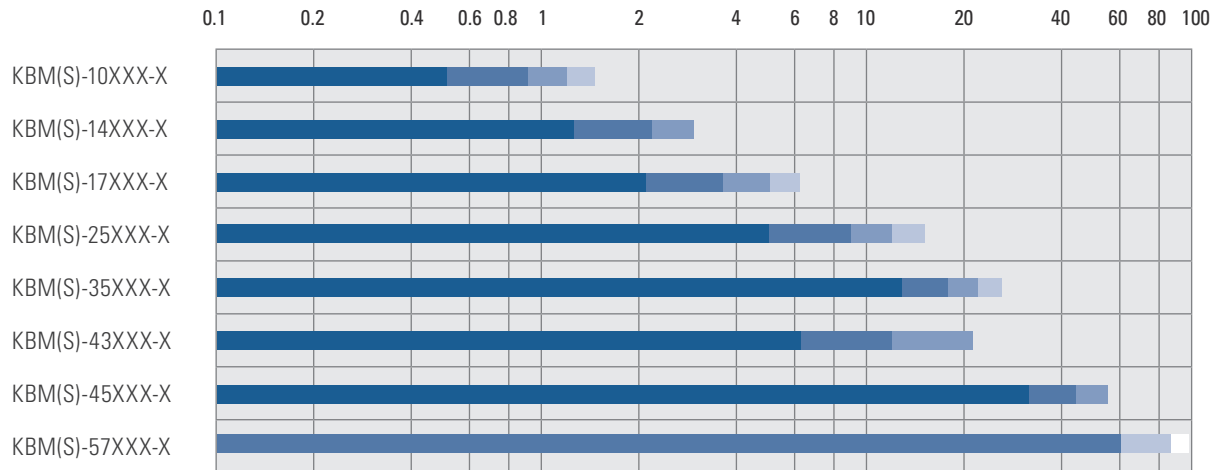

Continuous Standstill Torque Tc in Nm

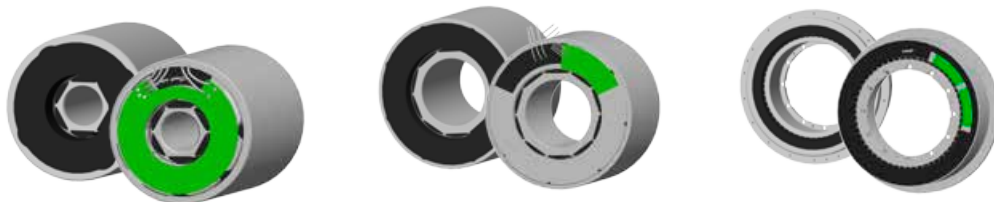
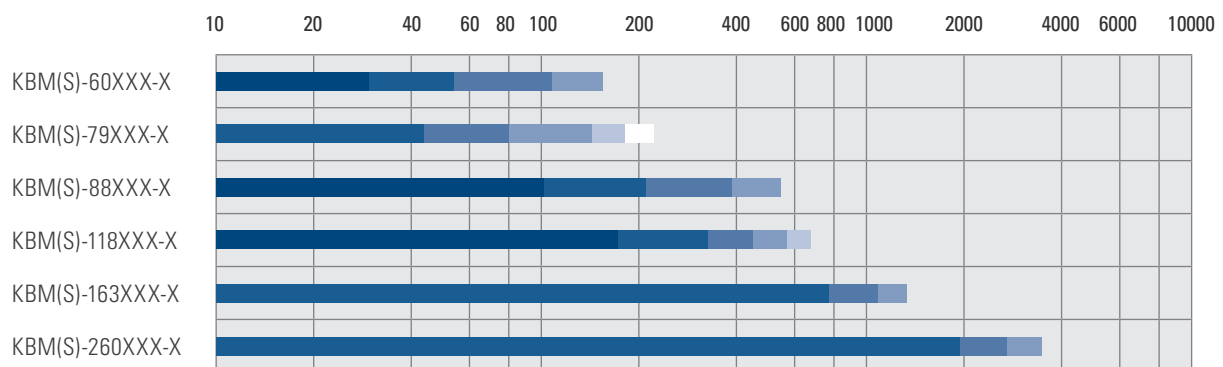

You can find more information and interactive 3D models with 2D product views at www.kollmorgen.com.

Performance Data

KBM(S)-	Servo amp. type	Continuous standstill torque ¹⁾ [Nm]	Continuous standstill current [A]	Peak standstill moment ²⁾ [Nm]	Peak current [A]	Rated speed [rpm ⁻¹]	Rated power ^{1),3)} [W]	Weight KBM/KBMS	Moment of inertia KBM/KBMS
10X01-A	00307	0.487	1.73	1.17	4.33	15200	550	0.379 / 0.425	4.92E-6 / 1.03E-5
10X01-B	00606	0.509	3.37	1.19	8.70	18500	600	0.379 / 0.425	4.92E-6 / 1.03E-5
10X01-C	00606	0.492	5.21	1.23	13.8	18600	575	0.379 / 0.425	4.92E-6 / 1.03E-5
10X02-A	00307	0.876	1.53	2.33	4.33	11000	740	0.658 / 0.703	1.03E-5 / 1.49E-5
10X02-B	00307	0.899	3.00	2.48	8.65	15200	785	0.658 / 0.703	1.03E-5 / 1.49E-5
10X02-C	00606	0.868	5.14	2.24	15.5	17000	710	0.658 / 0.703	1.03E-5 / 1.49E-5
10X03-A	00307	1.16	1.54	3.46	4.86	8500	780	0.943 / 0.990	1.55E-5 / 2.02E-5
10X03-B	00307	1.16	2.40	3.53	7.73	14300	740	0.943 / 0.990	1.55E-5 / 2.02E-5
10X03-C	00607	1.19	3.10	3.58	9.72	14500	725	0.943 / 0.990	1.55E-5 / 2.02E-5
10X03-D	00606	1.18	4.66	3.69	15.5	13000	850	0.943 / 0.990	1.55E-5 / 2.02E-5
10X04-A	00307	1.45	1.60	4.66	5.46	7050	820	1.22 / 1.26	2.01E-5 / 2.55E-5
10X04-B	00307	1.41	2.40	4.75	8.70	11500	860	1.22 / 1.26	2.01E-5 / 2.55E-5
10X04-C	00607	1.44	3.10	4.80	10.9	12000	835	1.22 / 1.26	2.01E-5 / 2.55E-5
10X04-D	00606	1.41	4.21	4.91	15.5	9500	910	1.22 / 1.26	2.01E-5 / 2.55E-5
14X01-A	00307	1.22	1.53	3.28	4.32	7950	735	0.898 / 1.00	2.41E-5 / 3.36E-5
14X01-B	00607	1.25	3.25	3.43	9.63	12000	700	0.898 / 1.00	2.41E-5 / 3.36E-5
14X01-C	01206	1.21	6.25	3.59	19.4	13500	915	0.898 / 1.00	2.41E-5 / 3.36E-5
14X02-A	00370	2.08	1.59	6.67	5.39	4900	845	1.59 / 1.68	4.88E-5 / 5.56E-5
14X02-B	00307	2.08	2.42	6.83	8.57	7700	1000	1.59 / 1.68	4.88E-5 / 5.56E-5
14X02-C	00607	2.11	3.10	6.98	10.9	10250 / 8000	585 / 1000	1.59 / 1.68	4.88E-5 / 5.56E-5
14X02-D	01206	2.17	5.97	7.31	21.8	8900	975	1.59 / 1.68	4.88E-5 / 5.56E-5
14X03-A	00307	2.82	1.64	10.1	6.12	3600	875	2.98 / 3.08	7.31E-5 / 8.81E-5
14X03-B	00307	2.87	2.81	10.5	10.9	6500 / 5225	1215 / 1175	2.98 / 3.08	7.31E-5 / 8.81E-5
14X03-C	01206	2.92	6.04	10.5	24.5	6600	1230	2.98 / 3.08	7.31E-5 / 8.81E-5
17X01-A	00307	2.08	1.65	5.95	5.45	4650	810	1.05 / 1.16	5.12E-5 / 8.62E-5
17X01-B	00607	2.06	3.11	6.14	10.9	9600 / 8125	715 / 955	1.05 / 1.16	5.12E-5 / 8.62E-5
17X01-C	01206	2.07	6.10	6.35	21.8	9050	855	1.05 / 1.16	5.12E-5 / 8.62E-5
17X02-A	00307	3.58	1.59	12.2	6.08	2600	835	1.87 / 1.97	9.45E-5 / 1.28E-4
17X02-B	00307	3.52	3.00	12.3	12.2	5450	1270	1.87 / 1.97	9.45E-5 / 1.28E-4
17X02-C	00607	3.57	5.27	12.7	21.9	7560	790	1.87 / 1.97	9.45E-5 / 1.28E-4
17X02-D	01206	3.58	6.25	12.8	24.5	5600	1290	1.87 / 1.97	9.45E-5 / 1.28E-4
17X03-A	00607	4.89	3.06	18.5	13.8	3950	1440	2.65 / 2.76	1.42E-4 / 1.75E-4
17X03-B	00607	4.90	5.32	18.8	24.4	6500	890	2.65 / 2.76	1.42E-4 / 1.75E-4
17X03-C	01207	5.00	6.14	18.8	27.2	6480	965	2.65 / 2.76	1.42E-4 / 1.75E-4
17X03-D	01206	5.00	10.4	19.0	48.0	6100	1275	2.65 / 2.76	1.42E-4 / 1.75E-4
17X04-A	00607	6.20	3.26	23.7	14.5	3350	1520	3.62 / 3.72	2.03E-4 / 2.40E-4
17X04-B	00607	6.12	5.53	23.7	25.0	5700	1075	3.62 / 3.72	2.03E-4 / 2.40E-4
17X04-C	01207	5.90	6.20	23.7	28.1	5775	975	3.62 / 3.72	2.03E-4 / 2.40E-4
17X04-D	01206	5.90	9.56	24.0	44.0	5000	1550	3.62 / 3.72	2.03E-4 / 2.40E-4
25X01-A	00607	4.90	3.10	14.4	10.9	3800	1110	1.79 / 2.02	2.66E-4 / 4.34E-4
25X01-B	00607	4.96	5.34	14.6	19.3	4900	730	1.79 / 2.02	2.66E-4 / 4.34E-4
25X01-C	01206	4.85	6.45	15.0	27.6	4225	1025	1.79 / 2.02	2.66E-4 / 4.34E-4
25X01-D	01206	4.75	7.95	14.9	34.3	4000	1100	1.79 / 2.02	2.66E-4 / 4.34E-4
25X02-A	00607	8.70	3.33	29.4	13.9	2300	1765	3.27 / 3.50	5.15E-4 / 6.78E-4
25X02-B	00607	8.75	5.18	29.7	22.0	4000	2545	3.27 / 3.50	5.15E-4 / 6.78E-4
25X02-C	01207	8.75	6.50	29.7	27.8	5000	2535	3.27 / 3.50	5.15E-4 / 6.78E-4
25X02-D	01207	8.62	8.00	29.8	35.1	6000	1790	3.27 / 3.50	5.15E-4 / 6.78E-4
25X02-E	01207	8.85	10.20	29.8	43.3	6000	1850	3.27 / 3.50	5.15E-4 / 6.78E-4
25X03-A	00607	11.6	5.30	42.2	23.9	2900	2700	4.72 / 4.90	7.66E-4 / 9.31E-4
25X03-B	01207	11.9	7.27	42.3	33.0	4150	2890	4.72 / 4.90	7.66E-4 / 9.31E-4
25X03-C	01207	11.9	8.20	42.4	37.0	4725	2585	4.72 / 4.90	7.66E-4 / 9.31E-4
25X03-D	01207	11.9	10.2	42.6	47.0	2700	2605	4.72 / 4.90	7.66E-4 / 9.31E-4
25X04-A	00607	14.8	5.50	54.4	25.0	2400	2865	6.17 / 6.35	1.02E-3 / 1.18E-3
25X04-B	01207	14.9	6.25	53.8	27.5	2700	3090	6.17 / 6.35	1.02E-3 / 1.18E-3
25X04-C	01207	15.0	8.70	54.4	38.5	3850	3255	6.17 / 6.35	1.02E-3 / 1.18E-3
25X04-D	01207	14.9	10.7	54.8	48.5	4700	1990	6.17 / 6.35	1.02E-3 / 1.18E-3
25X04-E	02407	14.6	13.8	53.8	62.5	4700	1940	6.17 / 6.35	1.02E-3 / 1.18E-3

1) Winding temperature = 155°C in continuous standstill and rated power and as per the power curves 2) With winding temperature at 25°C 3) With ambient temperature at 25°C

KBM Frameless Direct Drives

Performance Data

KBM(S)-	Servo amp. type	Continuous standstill torque ¹⁾ [Nm]	Continuous standstill current [A]	Peak standstill moment ²⁾ [Nm]	Peak current [A]	Rated speed [rpm ⁻¹]	Rated power ^{1),3)} [W]	Weight KBM/KBMS	Moment of inertia KBM/KBMS
35X01-A	00607	12.6	5.41	40.9	21.9	2700	2970	4.68/5.17	1.52E-3/2.17E-3
35X01-B	01207	12.7	6.10	40.8	24.5	2900	3100	4.68/5.17	1.52E-3/2.17E-3
35X01-C	01207	12.4	8.32	41.1	34.7	4200	3885	4.68/5.17	1.52E-3/2.17E-3
35X01-D	01207	12.7	10.6	41.2	43.5	5800	3750	4.68/5.17	1.52E-3/2.17E-3
35X01-E	01207	12.2	12.9	41.1	55.4	6125	3200	4.68/5.17	1.52E-3/2.17E-3
35X02-A	00607	17.3	4.97	58.8	22.5	1750	2750	6.76/7.21	2.28E-3/2.94E-3
35X02-B	01207	17.6	6.30	58.8	28.0	2200	3415	6.76/7.21	2.28E-3/2.94E-3
35X02-C	01207	17.5	8.70	59.2	39.2	3200	4395	6.76/7.21	2.28E-3/2.94E-3
35X02-D	01207	17.5	10.9	59.4	49.5	4300	4750	6.76/7.21	2.28E-3/2.94E-3
35X02-E	02407	17.1	12.1	59.4	55.4	3765	4610	6.76/7.21	2.28E-3/2.94E-3
35X03-A	01207	21.8	10.2	76.1	46.1	3100	5025	8.80/9.34	3.04E-3/3.70E-3
35X03-B	02407	21.7	14.0	76.6	64.0	4800	5160	8.80/9.34	3.04E-3/3.70E-3
35X03-C	02407	20.7	20.2	75.2	93.1	5000	2985	8.80/9.34	3.04E-3/3.70E-3
35X03-D	02406	20.0	21.5	75.7	104	3400	4735	8.80/9.34	3.04E-3/3.70E-3
35X04-A	01207	25.6	10.9	92.3	49.0	2800	5400	10.9/11.3	3.81E-3/4.46E-3
35X04-B	02407	25.9	13.3	93.0	61.0	3400	5750	10.9/11.3	3.81E-3/4.46E-3
35X04-C	02407	25.3	14.7	93.0	68.0	4150	4870	10.9/11.3	3.81E-3/4.46E-3
35X04-D	02407	24.7	19.2	91.5	89.0	4250	4500	10.9/11.3	3.81E-3/4.46E-3
43X01-A	00607	6.11	5.10	18.0	18.0	4750	1230	2.26/2.66	1.94E-3/2.85E-3
43X01-B	01206	6.24	8.60	18.0	32.2	4750	1230	2.26/2.66	1.94E-3/2.85E-3
43X01-C	02406	6.11	18.4	18.0	64.6	4750	1230	2.26/2.66	1.94E-3/2.85E-3
43X02-A	00607	11.6	5.10	34.6	18.0	3000	2160	3.49/3.89	2.85E-3/3.73E-3
43X02-B	02406	11.6	18.3	34.6	64.6	2650	2160	3.49/3.89	2.85E-3/3.73E-3
43X02-C	01207	11.9	6.10	34.6	22.8	3000	2160	3.49/3.89	2.85E-3/3.73E-3
43X02-D	01206	11.9	10.2	34.6	36.2	3000	2160	3.49/3.89	2.85E-3/3.73E-3
43X03-A	00607	21.0	4.78	64.5	18.0	1500	2520	5.96/6.35	4.75E-3/5.69E-3
43X03-B	02406	20.7	13.8	64.5	51.2	2275	2875	5.96/6.35	4.75E-3/5.69E-3
43X03-C	00607	20.9	5.73	64.5	22.8	1500	2520	5.96/6.35	4.75E-3/5.69E-3
43X03-D	02406	20.9	19.2	64.5	72.5	1500	2520	5.96/6.35	4.75E-3/5.69E-3
43X04-A	00607	35.1	4.78	113	18.0	830	2600	8.85/9.25	6.44E-3/6.85E-3
43X04-B	00607	35.1	5.60	113	22.8	830	2600	8.85/9.25	6.44E-3/6.85E-3
43X04-C	01206	35.1	9.20	113	36.2	830	2600	8.85/9.25	6.44E-3/6.85E-3
43X05-A	00607	44.2	4.50	153	18.0	620	3500	11.80/12.20	8.54E-3/9.44E-3
43X05-B	00607	44.2	4.50	153	22.8	620	2550	11.80/12.20	8.54E-3/9.44E-3
43X05-C	01206	44.2	4.50	153	36.2	620	2500	11.80/12.20	8.54E-3/9.44E-3
45X01-A	01207	30.7	10.2	119	46.5	2100	5200	12.2/13.2	6.10E-3/8.35E-3
45X01-B	02407	30.2	12.5	119	57.5	2650	5750	12.2/13.2	6.10E-3/8.35E-3
45X01-C	02407	31.3	14.3	119	65.0	3100	6045	12.2/13.2	6.10E-3/8.35E-3
45X01-D	02407	29.7	20.2	118	93.5	3700	4930	17.5/18.5	9.22E-3/1.15E-2
45X02-A	02407	43.7	13.3	170	60.5	1950	6655	17.5/18.5	9.22E-3/1.15E-2
45X02-B	02407	43.5	14.9	171	68.0	2350	7200	17.5/18.5	9.22E-3/1.15E-2
45X02-C	02407	41.9	21.1	168	97.2	3500/2830	4525/6500	23.1/24.2	1.22E-2/1.45E-2
45X03-A	02407	54.6	14.1	218	64.5	1700	7270	23.1/24.2	1.22E-2/1.45E-2
45X02-B	02407	53.0	19.9	215	92.5	2600/2050	7580/7670	23.1/24.2	1.22E-2/1.45E-2
57X01-A	00607	18.8	5.68	60.0	23.4	2050	2310	4.54/5.31	6.56E-3/9.49E-3
57X01-B	01207	18.8	6.90	60.0	27.9	2050	2310	4.54/5.31	6.56E-3/9.49E-3
57X01-C	02406	18.8	11.4	60.0	47.0	2050	2310	4.54/5.31	6.56E-3/9.49E-3
57X02-A	00607	33.5	5.23	115	23.4	1015	2660	7.89/8.62	1.18E-2/1.49E-2
57X02-B	01207	33.5	6.24	115	27.9	1015	2660	7.89/8.62	1.18E-2/1.49E-2
57X02-C	02406	33.5	11.0	115	47.0	1015	2660	7.89/8.62	1.18E-2/1.49E-2
57X03-A	00607	60.0	5.47	2108	26.1	580	3000	14.5/15.4	2.21E-2/2.52E-2
57X03-B	01207	60.0	6.70	218	32.9	580	3000	14.5/15.4	2.21E-2/2.52E-2
57X03-C	02406	60.0	11.0	218	52.4	580	3000	14.5/15.4	2.21E-2/2.52E-2
57X04-A	00607	85.3	5.20	332	26.1	375	2880	22.0/22.9	3.44E-2/3.78E-2
57X04-B	01207	85.3	6.50	332	32.9	375	2880	22.0/22.9	3.44E-2/3.78E-2
57X04-C	02406	85.3	10.6	332	52.4	375	2880	22.0/22.9	3.44E-2/3.78E-2

1) Winding temperature = 155°C in continuous standstill and rated power and as per the power curves 2) With winding temperature at 25°C 3) With ambient temperature at 25°C

Performance Data

KBM(S)-	Servo amp. type	Continuous standstill torque ¹⁾ [Nm]	Continuous standstill current [A]	Peak standstill moment ²⁾ [Nm]	Peak current [A]	Rated speed [rpm ⁻¹]	Rated power ^{1),3)} [W]	Weight KBM/KBMS	Moment of inertia KBM/KBMS
57X05-A	00607	109	5.00	441	26.1	265	2675	29.2/30.1	4.58E-2/4.91E-2
57X05-B	01207	109	6.20	441	32.9	265	2675	29.2/30.1	4.58E-2/4.91E-2
57X05-C	02406	109	10.0	441	52.4	265	2675	29.2/30.1	4.58E-2/4.91E-2
60X00-A	02407	29.4	13.7	69.1	40.0	1700	2960	8.30/10.4	9.53E-3/1.88E-2
60X00-B	02407	29.4	16.8	69.1	50.4	1700	2960	8.30/10.4	9.53E-3/1.88E-2
60X00-C	02406	29.4	22.5	69.1	63.6	1700	2960	8.30/10.4	9.53E-3/1.88E-2
60X01-A	02407	53.9	13.7	127	40.0	1600	4165	13.2/15.3	1.63E-2/2.56E-2
60X01-B	02407	53.9	16.9	127	50.4	1600	4165	13.2/15.3	1.63E-2/2.56E-2
60X01-C	02408	53.9	22.7	127	78.0	1600	4165	13.2/15.3	1.63E-2/2.56E-2
60X02-A	02407	108	16.3	243	50.4	885	6985	25.2/27.9	3.17E-2/4.20E-2
60X02-B	02407	108	19.6	243	60.4	885	6985	25.2/27.9	3.17E-2/4.20E-2
60X03-A	02407	154	18.6	393	63.3	720	8350	37.2/39.8	4.75E-2/5.29E-2
60X03-B	S748	154	24.0	393	76.8	730	8420	37.2/39.8	4.75E-2/5.29E-2
79X01-A	00607	43.5	4.95	152	20.8	730	2585	9.21/10.7	3.25E-2/4.45E-2
79X01-B	01207	43.5	6.00	152	25.3	730	2585	9.21/10.7	3.25E-2/4.45E-2
79X01-C	02406	43.5	10.0	152	41.7	730	2585	9.21/10.7	3.25E-2/4.45E-2
79X02-A	00607	79.6	5.40	319	26.1	430	2920	16.9/18.4	5.97E-2/7.15E-2
79X02-B	01207	79.6	6.50	319	31.4	430	2920	16.9/18.4	5.97E-2/7.15E-2
79X02-C	02406	79.6	11.0	319	52.4	430	2920	16.9/18.4	5.97E-2/7.15E-2
79X03-A	01207	143	6.76	637	36.7	300	3750	32.1/33.5	0.114/0.125
79X03-B	01207	143	8.00	637	46.3	300	3750	32.1/33.5	0.114/0.125
79X03-C	02406	143	13.2	637	73.7	290	3640	32.1/33.5	0.114/0.125
79X04-A	01207	180	6.60	858	36.7	215	3540	44.0/45.3	0.152/0.164
79X04-B	01207	180	7.80	858	46.3	215	3540	44.0/45.3	0.152/0.164
79X04-C	02406	180	12.8	858	73.7	215	3540	44.0/45.3	0.152/0.164
79X05-A	01207	222	6.30	1075	36.7	165	3330	54.9/56.2	0.191/0.202
79X05-B	01207	222	7.50	1075	46.3	165	3330	54.9/56.2	0.191/0.202
79X05-C	02406	222	12.1	1075	73.7	165	3330	54.9/56.2	0.191/0.202
88X00-A	02407	102	17.0	197	40.0	1000	5460	15.7/21.0	5.26E-2/0.103
88X00-B	02407	102	20.5	197	48.3	1000	5460	15.7/21.0	5.26E-2/0.103
88X00-C	S748	102	34.0	197	80.2	1000	5460	15.7/21.0	5.26E-2/0.103
88X01-A	02407	205	17.1	390	40.0	520	8250	37.6/42.6	9.84E-2/0.146
88X01-B	S748	209	32.1	390	75.4	940	6600	37.6/42.6	9.84E-2/0.146
88X01-C	01207	205	7.50	390	17.8	205	3870	37.6/42.6	9.84E-2/0.146
88X01-D	S748	207	40.2	390	94.7	940	6600	37.6/42.6	9.84E-2/0.146
88X02-A	02407	385	15.1	789	40.0	235	7950	72.6/77.6	0.198/0.247
88X02-B	S748	385	32.1	789	75.4	550	13430	72.6/77.6	0.198/0.247
88X02-C	S748	385	37.9	789	89.0	550	13430	72.6/77.6	0.198/0.247
88X03-A	02407	538	18.2	1200	53.1	225	10450	106/111	0.298/0.315
88X03-B	S748	545	35.5	1200	106	425	16000	106/111	0.298/0.315
88X03-C	S748	545	45.2	1200	134	425	16000	106/111	0.298/0.315
118X00-A	02407	172	21.6	498	67.0	830	7780	18.9/21.2	0.129/0.176
118X00-B	S748	172	27.0	498	84.0	830	7780	18.9/21.2	0.129/0.176
118X00-C	S748	172	40.2	498	135	830	7780	18.9/21.2	0.129/0.176
118X01-A	S748	325	43.7	994	151	785	9000	37.1/39.2	0.267/0.315
118X01-B	S772	325	76.5	994	265	785	9000	37.1/39.2	0.267/0.315
118X02-A	S748	446	47.0	1451	171	710	10350	53.4/56.2	0.396/0.403
118X02-B	S772	446	57.0	1451	206	710	10350	53.4/56.2	0.396/0.403
118X02-C	S772	446	94.5	1255	343	710	10350	53.4/56.2	0.396/0.403
118X03-A	S748	560	44.0	1932	171	535	17000	71.7/73.9	0.542/0.591
118X03-B	S772	560	54.0	1932	206	535	17000	71.7/73.9	0.542/0.591
118X03-C	S772	560	89.5	1661	343	535	17000	71.7/73.9	0.542/0.591
118X04-A	S748	672	42.8	2400	171	420	19850	88.5/90.7	0.648/0.698
118X04-B	S772	672	51.5	2400	206	420	19850	88.5/90.7	0.648/0.698
118X04-C	S772	672	86.0	2068	343	420	19850	88.5/90.7	0.648/0.698

1) Winding temperature = 155°C in continuous standstill and rated power and as per the power curves 2) With winding temperature at 25°C 3) With ambient temperature at 25°C

KBM Frameless Direct Drives

Performance Data

KBM(S)-	Servo amp. type	Continuous standstill torque ¹⁾ [Nm]	Continuous standstill current [A]	Peak standstill moment ²⁾ [Nm]	Peak current [A]	Rated speed [rpm ⁻¹]	Rated power ^{1),3)} [W]	Weight KBM/KBMS	Moment of inertia KBM/KBMS
163X01-A	S748	764	41.5	1966	140	375	17300	90.7/96.2	1.06/1.23
163X01-B	S722	764	47.0	1966	158	350	17400	90.7/96.2	1.06/1.23
163X01-C	S722	764	74.5	1966	253	335	17300	90.7/96.2	1.06/1.23
163X02-A	S748	1084	39.5	2915	140	245	20100	131/136	1.57/1.72
163X02-B	S772	1084	44.0	2915	158	225	19120	131/136	1.57/1.72
163X02-C	S772	1084	73.0	2915	253	215	18065	131/136	1.57/1.72
163X03-A	S748	1329	38.6	3932	140	180	20100	161/166	1.68/1.83
163X03-B	S772	1329	44.0	3932	157	165	18810	161/166	1.68/1.83
163X03-C	S772	1329	70.0	3932	253	160	17420	161/166	1.68/1.83
260X01-A	S748	1932	33.1	6494	147	105	18500	170/177	4.88/5.45
260X01-B	S748	1932	39.0	6494	171	100	17675	170/177	4.88/5.45
260X01-C	S772	1932	58.0	6494	257	90	16100	170/177	4.88/5.45
260X02-A	S748	2706	31.0	9742	147	68	17150	249/257	7.19/7.86
260X02-B	S748	2706	36.5	9742	171	65	16400	249/257	7.19/7.86
260X02-C	S772	2706	54.5	9742	257	58	14715	249/257	7.19/7.86
260X03-A	S748	3445	29.5	12812	147	50	16200	329/336	9.56/10.2
260X03-B	S748	3445	34.5	12812	171	48	15570	329/336	9.56/10.2
260X03-C	S772	3445	52.0	12812	262	42	13710	329/336	9.56/10.2

1) Winding temperature = 155°C in continuous standstill and rated power and as per the power curves 2) With winding temperature at 25°C 3) With ambient temperature at 25°C

Dimensional drawings

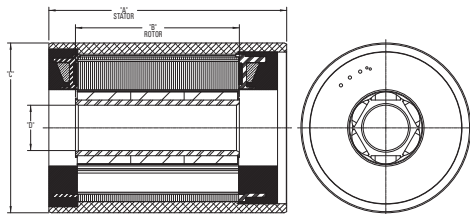

Image 1: KBM 10,14,17,25,35,45

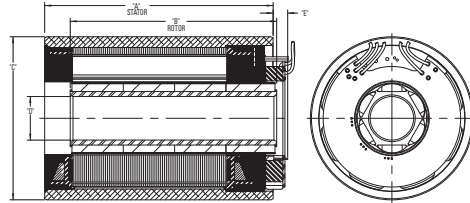

Image 2: KBMS 10,14,17,25,35,45

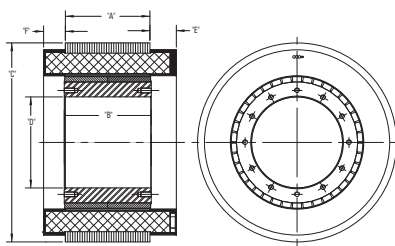

Image 3: KBM 43,57,60,88

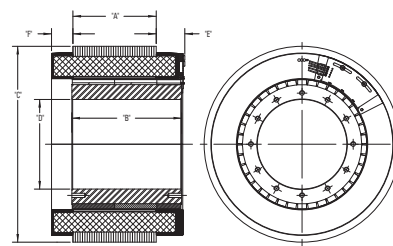

Image 4: KBMS 43,57,60,88

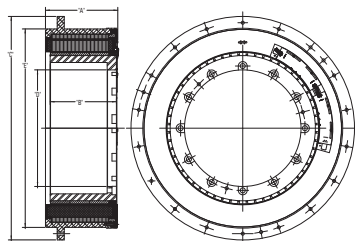

Image 5: KBM 79118,163260

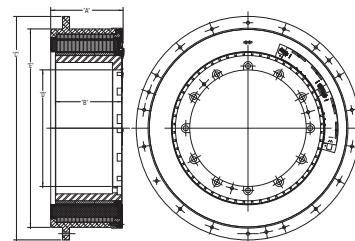

Image 6: KBMS 79118,163260

Dimensions (mm)

KBM(S)-	F	B (KBM)	B (KBMS)	C	D	E (KBM)	E (KBMS)	F	Dimensional drawing
10X01	46.00	20.14	38.17	59.97	16.01	–	5.75	–	Image 1/2
10X02	65.00	39.02	57.05						
10X03	84.00	57.89	75.92						
10X04	103.00	76.77	94.80						
14X01	58.00	32.16	50.19	74.97	20.01	–	5.75	–	Image 1/2
14X02	89.00	63.04	81.08						
14X03	120.00	93.93	111.96						
17X01	57.80	30.15	49.07	84.93	30.01	–	5.75	–	Image 1/2
17X02	86.30	59.03	77.95						
17X03	115.80	87.91	106.83						
17X04	144.80	116.79	135.71						
25X01	62.70	32.16	51.97	109.97	50.01	–	5.75	–	Image 1/2
25X02	93.70	63.05	82.86						
25X03	124.70	93.93	113.74						
25X04	155.70	124.82	144.63						
35X01	83.74	51.00	71.83	139.97	65.01	–	5.75	–	Image 1/2
35X02	108.74	75.87	96.70						
35X03	133.74	100.74	121.56						
35X04	158.74	125.60	146.43						
43X01	11.43	18.54	30.35	159.78	76.28	20.32	12.32	12.32	Image 3/4
43X02	22.86	29.97	41.78						
43X03	45.72	52.83	64.64						
43X04	80.26	87.38	99.19						
43X05	108.97	116.08	127.89						
45X01	107.06	69.04	92.41	189.96	85.02	–	5.75	–	Image 1/2
45X02	141.06		126.29						
45X03	175.05		160.17						
57X01	20.32	25.40	38.23						
57X02	40.64	45.72	58.54						
57X03	81.79	88.36	99.44						
57X04	123.82	129.16	141.98						
57X05	166.37	171.70	184.53						
60X00	26.62	29.39	57.53	229.85	105.05	30.48	33.65	25.15	Image 3/4
60X01	48.11	50.88	78.99						
60X02	97.71	100.48	128.78						
60X03	147.32	150.09	178.31						
79X01	31.75	38.10	52.07	259.63	152.43	13.34	21.20	13.34	Image 5/6
79X02	63.50	69.85	83.82						
79X03	127.00	133.35	147.07						
79X04	170.94	177.29	191.26						
79X05	214.89	221.49	235.46						
88X00	33.66	36.37	71.37	331.46	155.01	37.59	40.64	27.43	Image 3/4
88X01	67.56	70.36	105.41						
88X02	136.65	139.44	174.63						
88X03	205.74	208.53	243.84						
118X00	50.80	50.71	72.39	361.11	225.04	21.59	26.03	22.23	Image 5/6
118X01	101.60	104.14	123.83						
118X02	152.40	155.58	175.26						
118X03	203.20	207.26	226.70						
118X04	254.00	258.69	278.13	605.00	315.50	537.08	537.08	–	Image 5/6
163X01	142.54	106.93	126.24						
163X02	193.34	160.02	179.32						
163X03	244.14	213.11	232.41	850.00	557.85	781.81	781.81	–	Image 5/6
260X01	172.62	132.08	156.21						
260X02	237.39	196.85	220.98						
260X03	302.16	261.62	285.75						

– Change Motion task profile and clear fault with DRV.CLRFAULTS.

Direct Drive Technology

Precise, Fast, and Maintenance-free

Conventional servo systems usually possess a mechanical gearhead which may consist of gear wheels, gears, belts / belt pulleys, or cams, which are located between the motor and the weight.

With direct drive technology, the mechanical gearhead is omitted and the motor is connected to the load directly.

60 Times Better Repeatability

A "precision" planetary gearhead may have a backlash of 1 arc minute. That means the load moves by 1 arc minute with the motor absolutely still. The standard servo motors with rotary direct drive (DDR) from Kollmorgen offer repeatability of less than 1 arc second. A direct drive motor can therefore hold a position 60 times better than a conventional motor-gearhead combination.

The increased precision of direct drive technology improves the quality of the products that are manufactured with the machine:

- More precise print registration
- Cutting or feeding lengths can be held more precisely
- More accurate coordination with other machines
- More exact index positioning
- No adjustment problems due to backlash

Up to 2 Times Higher Throughput

Mechanical components for power transmission limit the speed with which you can start and stop a machine and prolong the required resting times. These factors restrict the machine's throughput potential.

Direct drive technology eliminates these restrictions and enables substantially quicker start/stop cycles and considerably reduced resting times. Consequently, the machine's throughput is increased. Users of direct drive systems report more than twice as much throughput.

Direct Drives are Maintenance-free and More Reliable

Gear wheels, belts, and other mechanical components for power transmission wear down. By doing away with these parts and using DDR motors, the reliability of the machine improves. In tough start/stop applications the gearheads must be lubricated or replaced regularly. Belts must be re-tensioned regularly. A direct drive motor does not contain any wear parts and is therefore totally maintenance-free.

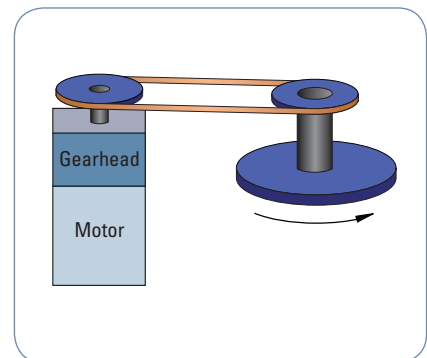

Conventional drive with servo motor and gearhead

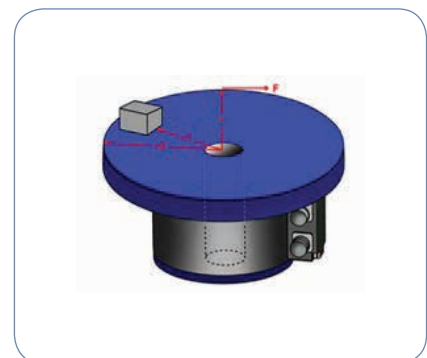

Direct drive without mechanical components

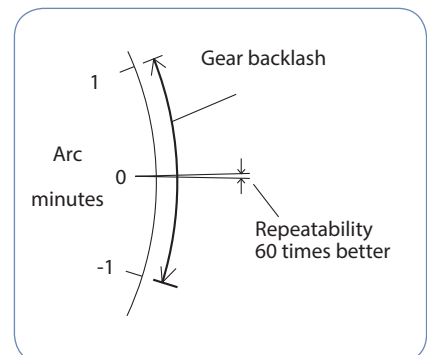

Improved repeatability

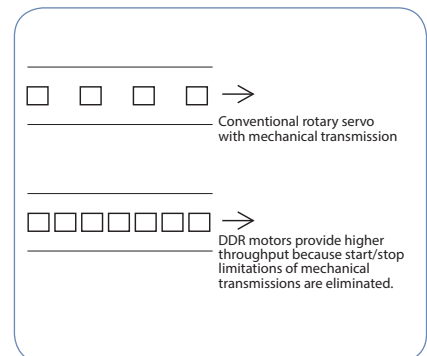

Higher throughput

Simple Structure Due to Direct Load Coupling

With direct drives you only require the motor and the assembly bolts – holders, covers, belts, belt pulleys, clamping elements, couplings, and bolts are unnecessary. This provides the following advantages:

- Fewer parts on the parts list: Fewer parts to procure, schedule, and warehouse.
- The assembly time is cut from several hours with mechanical gearhead drives to a few minutes with DDR drives.
- Lower costs: Although a direct drive can be slightly more expensive than a conventional drive with comparable torque, due to the parts that are not required and the shorter assembly time, the overall costs are lower.

No Adjusting of Mass Inertia Required

Servo systems with mechanical gearheads require an adjustment to the mass inertia to limit the load inertia reacting on the motor shaft to 5 to 10 times the motor inertia. If this limit is exceeded, the system will be difficult to control due to a lack of stability. In order for the inertia ratio to be maintained, a larger motor must often be used in mechanical gearhead systems than is actually required.

With direct drive technology these design issues are eliminated. As the motor is connected directly to the load, the motor and load represent a combined overall inertia. Therefore, when using DDR motors no inertial adjustment is required. DDR applications have been operated in test runs with inertia ratios of over 11000 to 1.

Reduced Noise Development.

Since mechanical components are unnecessary for power transmission, machines with DDR motors generate a noise level 20 dB lower than the same machines with mechanical gearheads.

Cartridge DDR

The Cartridge DDR motor combines the space-saving properties and the power advantages of a DDR motor with no housing with the simple assembly of a housing motor. With a motor consisting of a rotor, a stator, and a factory-set high-resolution feedback unit, the rotor rests on the machine's bearings. The rotor is connected to the load using an innovative clamp coupling, and the housing of the motor is mounted on the machine like a conventional servo motor using a bolt circle with centering. This way space requirements and construction times are reduced and the entire system is simplified.



KBM frameless direct drives



Design of a Cartridge DDR motor (CDDR)



Simple load coupling with clamp coupling for the CDDR



Choice of 5 frame sizes, 17 lengths, and 52 standard windings for optimum drive design

Accessories



KCM-S Dynamic Braking Energy Storage

Save Energy through Intelligent Energy Feedback

- Substantial energy saving, especially in applications with short cycle times
- Simple connection to DC intermediate circuit
- Simple start-up – immediately ready for use; no adjustment; no controls
- Almost unlimited power range thanks to the expansion modules

The KCM-S dynamic storage module from Kollmorgen stores released braking energy and channels this back to the drive in the event of load increases. The KCM-S is simply connected parallel to the DC intermediate circuit and is ready for use immediately. The module automatically determines the value of starting voltage. Braking energy, which would lead to an increase in voltage over this threshold value, is saved in the KCM-S buffer module. If the voltage in the intermediate circuit falls short of the starting voltage, the KCM-S pumps power back which would otherwise have been drawn from the mains without the KCM-S. Power is saved at that moment. If the power level falls below the dynamically defined charge voltage, the KCM-S switches itself off and waits for the next brake action. The KCM-E expansion modules are available for higher power.

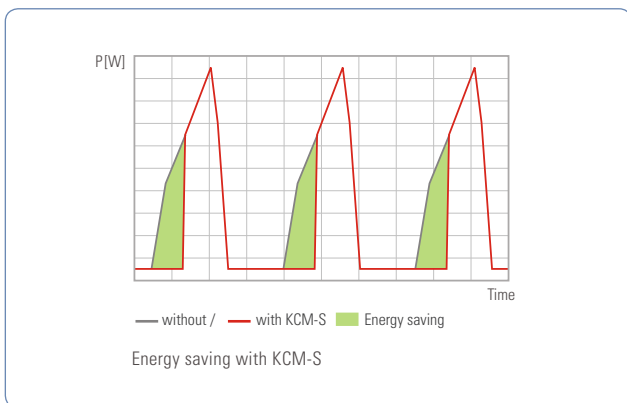

KCM-P Static Energy Storage

Protects against Damage Caused by Short-term Power Failure

- Supplies the drive with power in the event of power outages until the machine reaches a defined state after stopping
- Generates a power outage signal for evaluation by the machine control system
- Simple connection to the DC intermediate circuit with two cables; immediately ready for use; no adjustment; no controls
- Almost unlimited power range thanks to cascable

The KCM-P static energy storage expands the capacity in the DC intermediate circuit of a converter. It stores a certain amount of power which maintains the voltage in the DC intermediate circuit for a certain amount of time in the event of power failure. After activating the converter, the energy storage is charged in a controlled manner by a loading routine and is ready for use after roughly eight seconds. The gentle loading routine does not burden the converter's charging circuit and does not generate any negative circuit feedback. In the event of power interruptions, the digital interface outputs a signal for evaluation and the initiation of further actions by the machine control system. The KCM-E expansion modules are connected in parallel to the basic module and increase the capacity by 2000 Ws or 4000 Ws in each case.

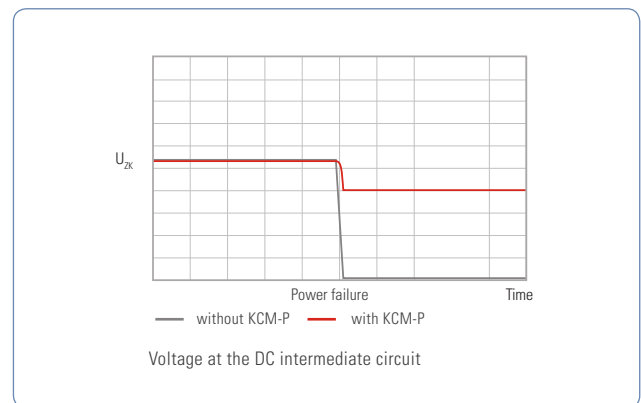

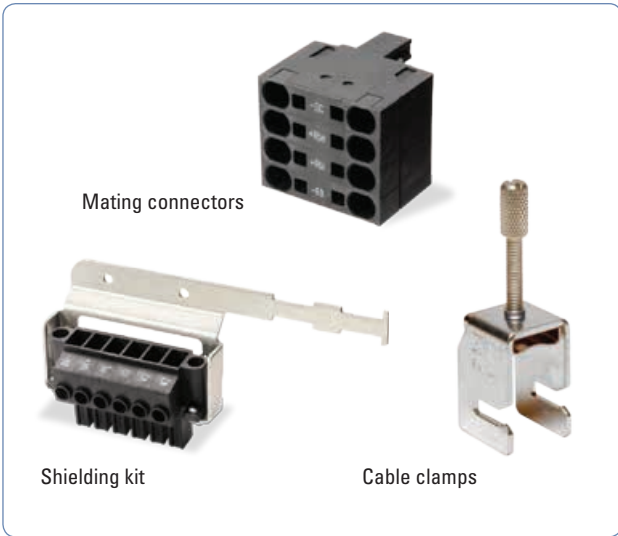

Mating Connectors and Shielding Kit

Kollmorgen's servo drives are equipped with screwable mating connectors. Alternative connectors for common DC, bus, and mains ports are also available. We offer shielding kits for our flexible cables for use in environments with strong interference.

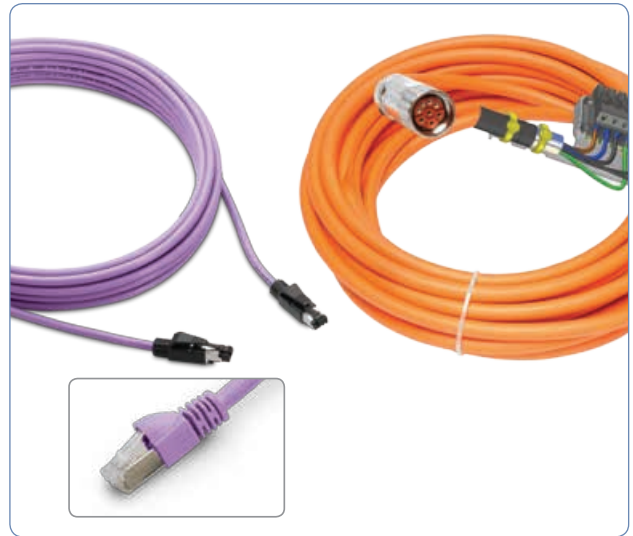

Connection Cables

Shielded PUR industrial cable with RJ45 connections for demanding industrial environments with increased requirements for EMC, durability, and service life. The motor connection and feedback cable are designed as shielded PUR industrial cables with CE and UL approval that are capable of being towed.



Braking Resistors

Braking resistors with up to 6000 Watt of power are available in numerous sizes and form factors. The impedance of the braking resistors is tailored to the Kollmorgen servo drives.



Chokes and Filters

Mains filters increase reliability and extend the service life of the machine in environments with unstable power supplies. Motor chokes reduce radiated disturbances.

You can find additional information on our accessories at www.kollmorgen.com

Model Nomenclature

AKD / AKD-N Servo Drives

AKD – P 003 07 – NB CC – 0000

AKD Series

Version

- P Position controller with motion tasks
- D BASIC
- M PDMM

Rated Current

- 003 3 A
- 006 6 A
- 012 12 A
- 024 24 A
- 048 48 A

Voltage

- 06 120/240 V AC, 1-ph / 3-ph
- 07 240/480 V AC, 3-ph

Version

0000 X11, X32

Connection Options

- AN Analog
- CN CANopen
- EC EtherCAT
- EI Ethernet/IP
- CC CANopen and EtherCAT**
- PN PROFINET

Expansions

- NB Without expansion
- IC I/O option card (only AKD-T)
- MC Motion control card 0.8 GHz
- M1 Motion control card 1.2 GHz

AKD – C 010 07 – CB EC – E000

AKD Series

Version

- C Central Power Supply IP20

Power Class

- 010 10 kW (17 kW @ 570 V DC)

Voltage Class

- 07 400 to 480 V AC, 3-ph

Customization

- x000 Standard (x = language)

Connection Option

- EC EtherCAT

Expansions

- CB No expansion

AKD – N 003 07 – DB EC – E000

AKD Series

Version

- N Near servo drive IP65/67

Current Class

- 003 3 arms
- 006 6 arms

Voltage Class

- 07 700 V DC

Customization

- x000 Standard (x = language)

Connection Option

- EC EtherCAT

Expansions

- DB Hybrid motor cable
- DF Feedback connector and tertiary fieldbus
- DS Feedback connector and local STO

Note: Options in blue type refer to standard products.

Model Nomenclature

S700 Servo Drive

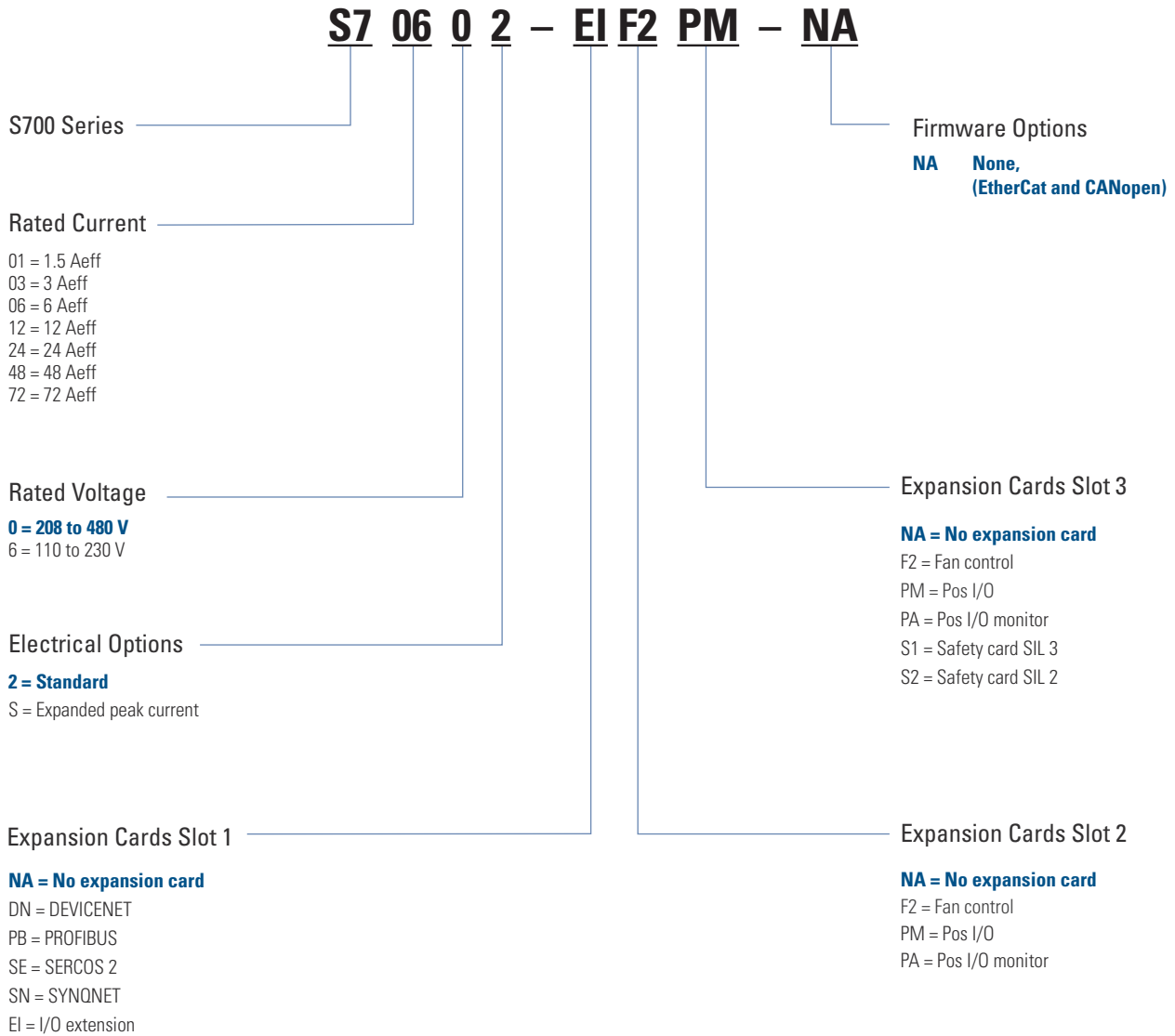

Note: Options in blue type refer to standard products.

Model Nomenclature

AKM Brushless Servo Motor

AKM 6 2 P – A N C N DA 00

AKM Series

Flange Size

- 1 40 mm
- 2 58 mm
- 3 70 mm
- 4 84 mm
- 5 108 mm
- 6 138 mm
- 7 188 mm
- 8 260 mm

Rotor Length

- 1
- 2
- 3
- 4
- 5

Winding Type

- A to Z
- S Special

Flange

- F** IEC with tolerance **N**
- W NEMA
- C Alternative IEC standard
- D Other standard
- G Alternative IEC standard
- H Alternative IEC standard
- R IEC with tolerance R
- M, T Reinforced bearing AKM8
- W Flange coating for Washdown, IEC
- S Special

Version

- 00** **X11, X32**
- 01 With shaft seal
- 0W Washdown
- 0F Washdown Food
- xx Special

Feedback Device

- For all options see opposite page
- S Special

Brake

- 2 24 V holding brake
- N** **Without brake**
- S Special

Connections

- For all options see opposite page
- S Special

Shaft

- C Keyway
- K Open keyway
- N** **Smooth shaft**
- S Special

Note: Options in blue type refer to standard products.

Feedback Unit Options

Code	Designation	Model	Can be used with	Connection option	Comment
1-	Comcorder		AKM1 - AKM8	1, 2, 7, B, C, G, H, T	1024 incr./rev
2-	Comcorder		AKM1 - AKM8	1, 2, 7, B, C, G, H, T	2048 incr./rev
AA	BiSS B encoder	AD36	AKM2 - AKM4	1, 7, B, C, M	Single-turn
AA	BiSS B encoder	AD58	AKM5 - AKM8	1, 2, C, G, H, M, T	Single-turn
AB	BiSS B encoder	AD36	AKM2 - AKM4	1,7,B, C, M	Multi-turn
AB	BiSS B encoder	AD58	AKM5 - AKM8	1, 2, C, G, H, M, T	Multi-turn
C-	Smart Feedback Device SFD	Size 10	AKM1	1, D, Y, M, P	Single-turn 4-wire
C-	Smart Feedback Device SFD	Size 15	AKM2 - AKM4	1, D, Y, M, P	Single-turn 4-wire
C-	Smart Feedback Device SFD	Size 21	AKM5 - AKM8	1, D, Y, M, P	Single-turn 4-wire
CA	Smart Feedback Device SFD3		AKM1 - AKM6	D	Single-turn 2-wire
DA	EnDAT 2.1 encoder	ECN 1113	AKM2 - AKM4	1, 7, B, C, M	Single-turn, optical
DA	EnDAT 2.1 encoder	ECN 1313	AKM5 - AKM8	1, 2, C, G, H, M, T	Single-turn, optical
DB	EnDAT 2.1 encoder	EQN 1125	AKM2 - AKM4	1, 7, B, C, M	Multi-turn, optical
DB	EnDAT 2.1 encoder	EQN 1325	AKM5 - AKM8	1, 2, C, G, H, M, T	Multi-turn, optical
LA	EnDAT 2.1 encoder	ECI 1118	AKM2 - AKM3	1, 7, B, C, M	Single-turn, inductive
LA	EnDAT 2.1 encoder	ECI 1319	AKM4 - AKM8	1, 2, C, G, H, M, T	Single-turn, inductive
LB	EnDAT 2.1 encoder	ECI 1130	AKM2 - AKM3	1,7, B, C, M	Multi-turn, inductive
LB	EnDAT 2.1 encoder	ECI 1331	AKM4 - AKM8	1, 2, C, G, H, M, T	Multi-turn, inductive
GA*	HIPERFACE encoder	SKS36	AKM2 - AKM8	1,2,7, B, C, G, H, M, T	Single-turn
GB*	HIPERFACE encoder	SKM36	AKM2 - AKM8	1,2,7, B, C, G, H, M, T	Multi-turn
GC	HIPERFACE encoder	SEK34	AKM1	1, Y, M	Single-turn, capacitive
GD	HIPERFACE encoder	SEL34	AKM1	1, Y, M	Multi-turn, capacitive
GE	Hiperface DSL encoder	EKS36	AKM2 - AKM8	D	Single-turn
GF	Hiperface DSL encoder	EKM36	AKM2 - AKM8	D	Multi-turn
R-	Resolvers	Size 10	AKM1	1,2,7, B, C, G, H, M, T, Y	2-pin, hollow shaft
R-	Resolvers	Size 15	AKM2 - AKM4	1,2,7, B, C, G, H, M, T, Y	2-pin, hollow shaft
R-	Resolvers	Size 21	AKM5 - AKM8	1,2,7, B, C, G, H, M, T, Y	2-pin, hollow shaft

* not available for AKM2 with connection option C (cable with IP65 connector)

Connector Options

Code		Can be used with	Protection class	Connection type	Description
With PTC	With KTY 84-130				
W	1	AKM2	IP65	2 threaded connectors, size 1.0	Angled, rotatable, mounted on motor
C	7	AKM1 - AKM2	IP65	2 threaded connectors, size 1.0	on 0.5 m cable
C	1	AKM3	IP65	2 threaded connectors, size 1.0	Angled, rotatable, mounted on motor
C	1	AKM4 - AKM7	IP65	2 Speed Tec Ready connectors, size 1.0	Angled, rotatable, mounted on motor
–	D	AKM1	IP65	1 hybrid i-tec connector	Mounted on motor
–	D	AKM2 - AKM6	IP65	1 hybrid threaded connector, size 1.0	Angled, rotatable, mounted on motor
G	–	AKM2 - AKM3	IP65	2 threaded connectors, size 1.0	Straight, mounted on motor
G	–	AKM4 - AKM6	IP65	2 Speed Tec Ready connectors, size 1.0	Straight, mounted on motor
H	1	AKM74Q and AKM82T	IP65	1 feedback threaded connector, size 1.0 1 power threaded connector, size 1.5	Angled, rotatable, mounted on motor
M	–	AKM1 - AKM4	IP20	2 Molex connectors, $I_0 < 6$ A	on 0.5 m cable
P	–	AKM1 - AKM4	IP20	1 Molex connector, $I_0 < 6$ A	on 0.5 m cable
D	2	AKM8	IP65	1 terminal box IP65 for power 1 Feedback threaded connector, size 1.0	Mounted on motor
Y	1	AKM1	IP65	1 y-tec® connector	Mounted on motor

Model Nomenclature

AKMH Hygienic Stainless Steel Servo Motor

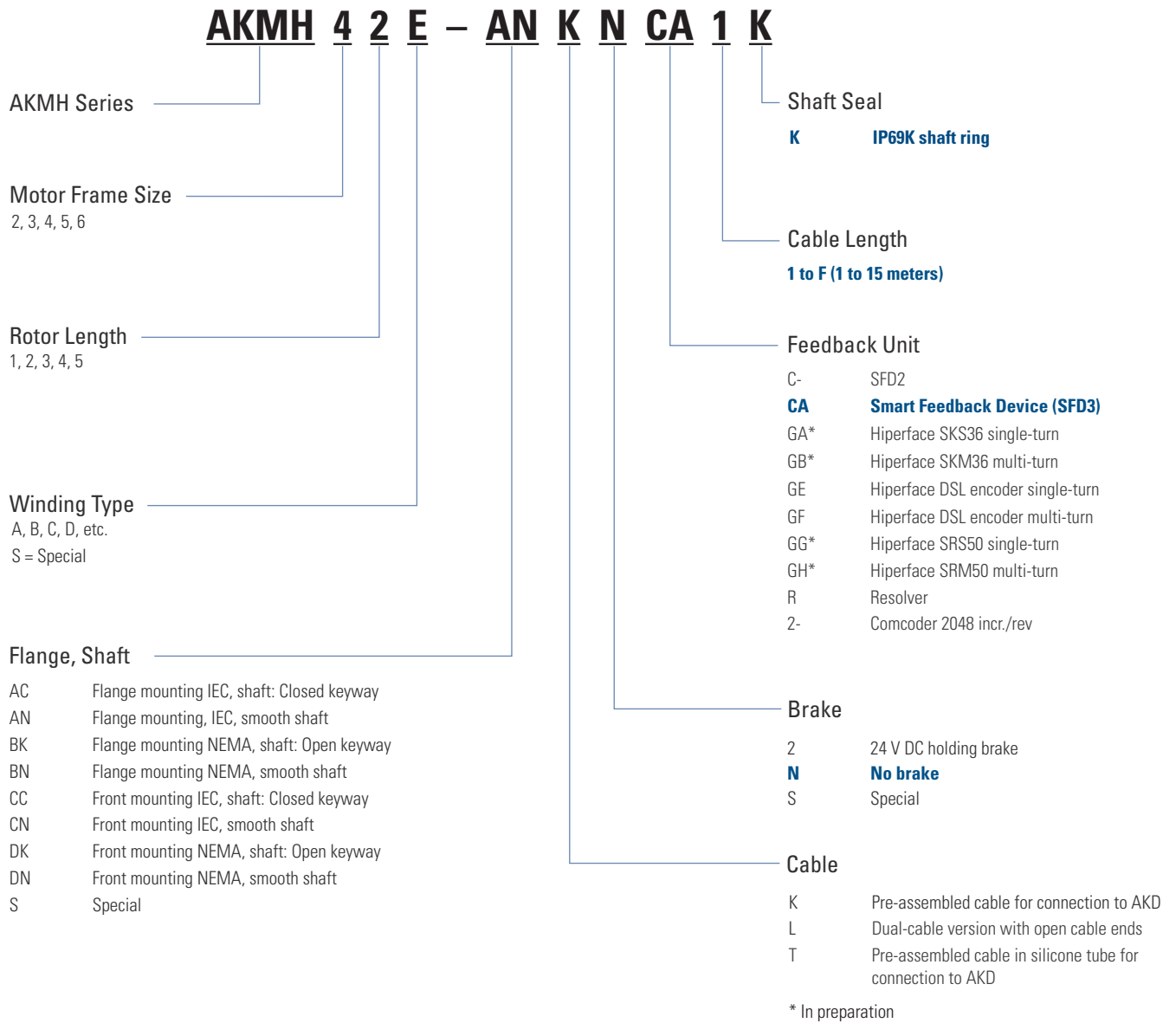

Model Nomenclature

VLM Servo Motor

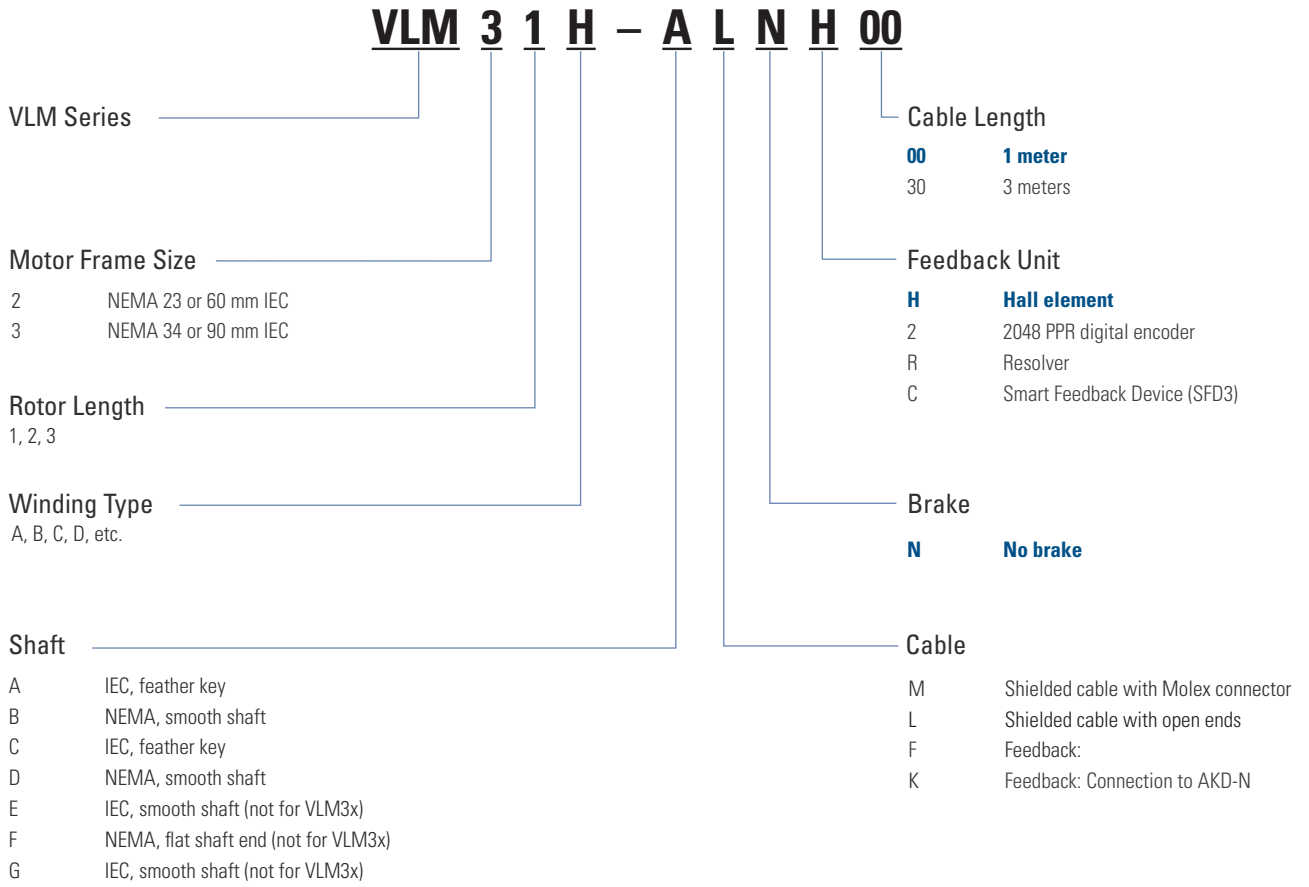

Model Nomenclature

ERD Hygienic Stainless Steel Linear Actuators

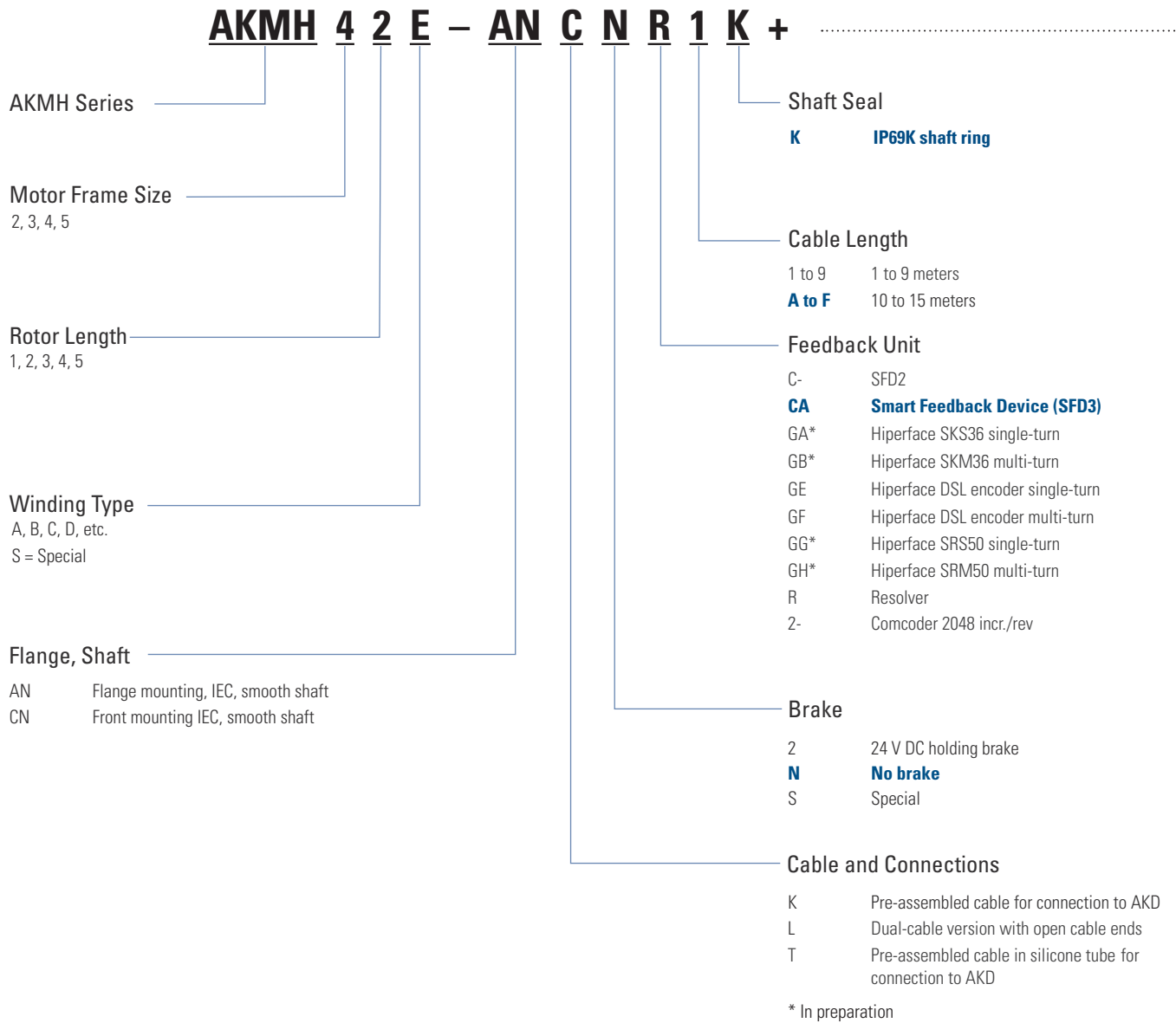

+ ERD 25 BNM05 SM150 LMI - 0

ERD Series

Motor/Actuator Combination
and Actuator Size

- 15 AKMH2 with ERD15
- 20 AKMH3 with ERD20
- 25 AKMH4 with ERD25
- 30 AKMH5 with ERD30

Ball Nut Lead

- BNM05 5 mm
- BNM10 10 mm

Version

- 0 Standard (FM2)
- 1 FFG
- 2 TRR
- 3 PCD
- S Special

Actuator Type

- LMI Motor in-line
- RP1 Motor reverse
(transmission ratio 1:1)

Feed

- SM150 150 mm
(configurable in 10 mm steps
from 150 mm to 600 mm)

Model Nomenclature

ICH Linear Direct Drives

ICH 22 - 050 - A1 - TY - HD - C1 - 0

ICH Series

Iron Core High Voltage

Design Length Identifier

11, 22, 33, 44

Coil Width

030, 050, 075, 100
150, 200, 250

Winding

A1, A5

Thermal Protection

TY PTC and KTY
(Standard)

Reserved for Customizations

00, 01, 02, etc.

Cable Options

Open ends

C1 400 mm

C2 200 mm

C3 100 mm

C4 1200 mm

With connected connector *

P1 400 mm

P2 200 mm

P3 100 mm

P4 1200 mm

* In preparation

Feedback Unit

00 Without hall effect sensors

HD Digital hall effect sensors

HA Analog hall effect sensors *

* In preparation

Model Nomenclature

MCH Magnetic Way

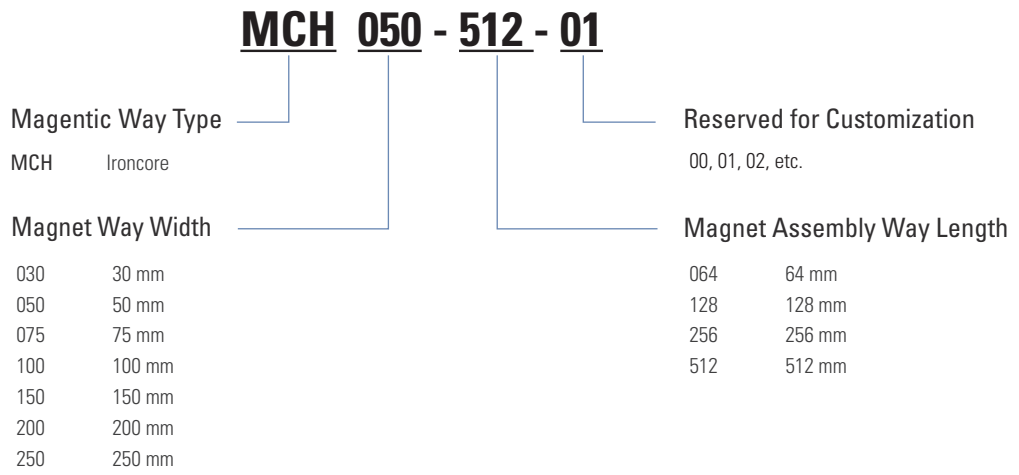

Model Nomenclature

Cartridge DDR Rotary Direct Drives

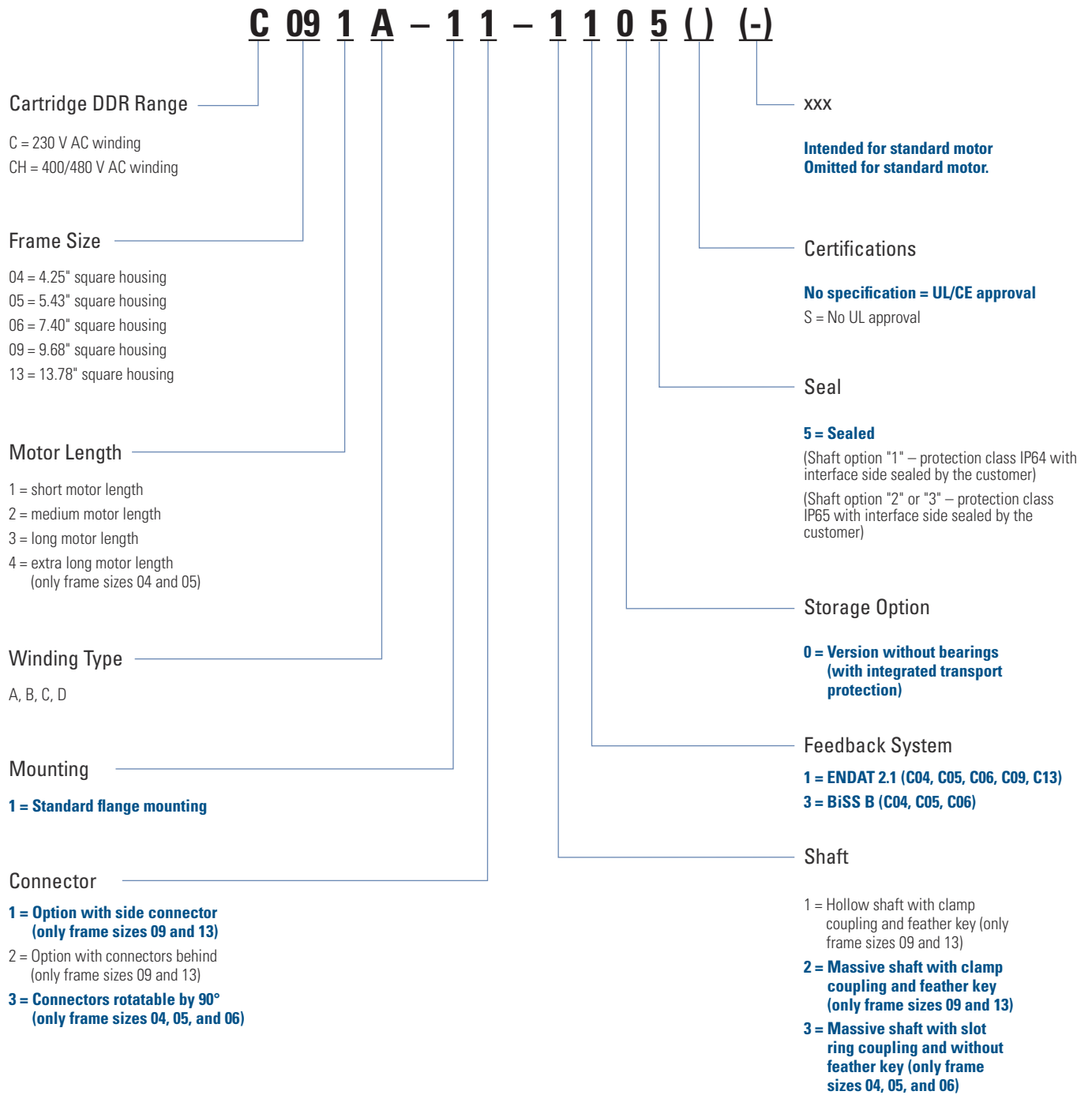

Note: Options in blue type refer to standard products.

Model Nomenclature

KBM Frameless Direct Drives

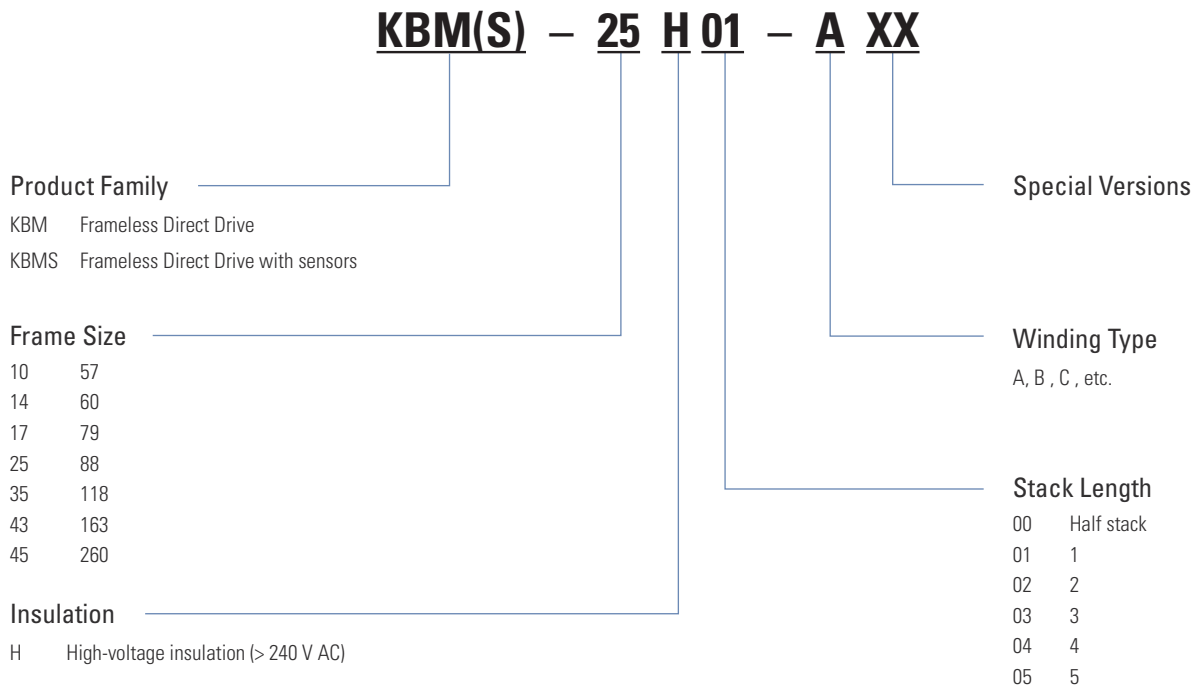

About Kollmorgen

Kollmorgen is a leading provider of drive systems and components for machine engineering. Through world-class knowledge in motion, industry-leading quality and deep expertise in linking and integrating standard and custom products, Kollmorgen delivers breakthrough solutions unmatched in performance, reliability and ease-of-use, giving machine builders an irrefutable marketplace advantage.

For assistance with your application needs, visit www.kollmorgen.com for a global contact list.

- Application Centers
- Worldwide Development and Production Locations
- Worldwide Production Locations



KOLLMORGEN®

Because Motion Matters™

KOLLMORGEN Europe GmbH
Pempelfurtstraße 1
40880 Ratingen
Germany
Telephone: +49 (0) 2102 9394 0
Fax: +49 (0) 2102 9394 3155