

ENG

www.phytron.eu

CATALOGUE STEPPER MOTORS

Precision for challenging applications

INDUSTRIAL
≤IP 54

HARSH
≤IP 68

EXTREME
VACUUM | CRYO |
RADIATION

SPACE
VIBRATION | VACUUM |
RADIATION

ZSS

ZSH

VSS

phySPACE

phyBASIC

Phytron GmbH

Stepper motor technology for special requirements:

Stepper motor technology is particularly suitable for precision applications under extreme environmental conditions. Whether vacuum, cryo environment, high temperature or under the influence of radioactivity - the phytron **motor series** are tough and do precision work, because stepper motors can position very accurately without a fragile feedback encoder.

Our **control units** perform, especially in applications that rely on very precise and smooth running behaviour. We control motors in electron microscopes, accelerator experiments or also in paper production machines - with up to 1/512 step (102 400 positions per revolution with a 200 step motor). From the power amplifier to the modular, cost-effective multi-axis system we offer the right control concept for your requirements. You remain flexible with phytron, because we supplement the interest in and the ability of our customised products by developing them further. Customers from different industry sectors rely on our decades of experience in highly demanding application fields.

Why buying a phytron product is always a good decision:

We are a customer-oriented high-technology company certified to ISO 9001 and EN13485. We have the process know-how of more than 300 stepper motors in space operations for the successful development of your demanding application!

We offer best service we also ask the right questions at the right time. Our Competence Center guarantees targeted consultation and therefore the early identification of requirements and any potential problems.

Based on our proven products used in the series, we develop solutions that provide precision work for our customers with extreme reliability. Whether for extreme environmental conditions or as a perfect fit for your particular application - phytron motors are always a good choice!

phytron combines the flexibility and client-specific consulting from a niche player with the efficiency and standardised quality assurance processes of series production. As quality conscious business we produce in Gröbenzell near Munich.



General Manager

INDUSTRIAL Environments

Precise. Reliable. Dynamic.

Phytron's STANDARD industrial motors are eminently suitable for applications in engineering and industry. Whether it's for the positioning of slides, the adjustment of pressure rollers or sensitive optics, the synchronised delivery and application of labels or for handling in mail sorting - fast and reliable running performances are constantly demanded. Precision, high torque and solid craftsmanship make our standard industrial motors an excellent choice for environments up to IP 50.

The *phyBASIC* series has good speed-torque performance, high low-end torque and a solid build, while the *ZSS* series prides itself with balanced rotors, smooth rotation, extremely low acoustic noise and low resonance with the highest positioning accuracy. Also, the *ZSS* operates to an extended operating temperature of -30 to +120 °C.



ZSS

Precision stepper motor with smooth running, IP 40, \varnothing 19 to 56 mm



phyBASIC

High precision and smooth running



DMP

Inertial damper for stepper motors DMP 29/37

HARSH Environments

Robust. Powerful. Dependable.

Phytron's HARSH Environment motors are particularly suited across a broad range of heavy-duty manufacturing industries. With precise running performance, high torque and its robust design to a submersible IP 68, the most challenging conditions are solved with our HARSH motors. In climate chambers, setting paper thickness in high humidity, the adjustment of rotor blades in aerospace or inside fuel tanks, these motors perform the most arduous of tasks accurately and reliably.



ZSH

Up to IP 68 stepper motors, \varnothing 57 to 107 mm

EXTREME Environments

Vacuum. Cryo. Radiation.

The Phytron EXTREME 2-phase hybrid stepper motors have evolved and perfected through the use of materials and manufacturing processes optimal for unusual environmental conditions in industry or science. Vacuums up to 10^{-11} mbar, cryogenic environments down to -269 °C, high temperatures up to +200 °C, radiations of up to 10^6 J / kg or extreme vibration loads - with minimal particulate emissions. These motors adjust optical elements in satellites, process samples in molecular analysis devices, turn filter wheels in sputtering and transport samples in liquid nitrogen.



VSS

Vacuum stepper motors \varnothing 19 to 125 mm

SPACE

Precise. Clean. Resistant.

With more than 25 years of heritage and more than 400 motors for a wide range of space projects (CASSINI-HUYGENES, EPIC ROSETTA, STEREO, KOMPSAT, CURIOSITY, JUNO, MAVEN, ENMAP, ...) we are looking forward to solving your challenging application! Our *phySPACE* withstands vibration and high shock loads, resists vacuum up to 10^{-11} hPa, radiation up to 10^6 J/kg, cryogenic environment down to -269 °C or high temperature up to 200 °C while achieving minimal outgassing.



phySPACE

Stepper motors for the space \varnothing 20 to 57 mm

CUSTOMISING

Standard + Efficient Customising = cost optimised for a perfect fit

Whether it's a tailored outer housing, ceramic bearings, high vibration and shock loads or rad-hard designs, the most unusual applications are solved based on a motor series with effective customisation by getting it right first time. We will assist you to combine standard components into a turnkey design that fits the bill.

ENG

www.phytron.eu/ZSS

ZSS Stepper Motors

For Applications with Extended Temperature Range

RoHS
compliant

The proven 2-phase hybrid stepper motors series ZSS combine highest precision with smooth running characteristics. With up to 102.400 approachable positions (200-step motor, driven in micro stepping mode with 1/512 step resolution and encoder) the ZSS motor provides your application with highest precision positioning capabilities.

The ZSS Serie differs from standard market motors by the extended ambient temperature range from -30 to +80 °C.

Thus, the motor is suitable for the most demanding applications in diverse areas of application.

Perfect-fit for your application:

- with gear
 - GPL low-backlash planetary gears
 - PLG planetary gears
 - HD Harmonic Drive gears
 - GSR worm gears
- with motor brake
 - Permanent magnet brake for 24 V_{DC} supply voltage
- with encoder
 - Standard resolution 500 lines
 - 3-channel optical incremental encoder

In Focus



high precision



temperature



smooth running

- 2-phase hybrid stepper motors
- 200-step (step angle 1.8°)
- Connection options:
 - 4-lead parallel
 - 4-lead in series
 - 5-, 6- or 8-lead connection
- Holding torques from 3.8 to 700 mNm
- Protection class IP 40 for ZSS with free wire ends
- Perm. ambient temperature -30 to +80 °C (no frost)
- Max. operating voltage of the power stage (Intermediate circuit voltage: 70 V_{DC})
- Insulation class F acc. to VDE 0530
- Test voltage
 - ZSS 19 to 52: 700 V (1 min)
 - ZSS 56 to 57: 1500 V (1 min)
- Optional:
 - 2nd shaft (IP 40)
 - encoder
 - gear
 - motor brake
- Customised shaft design
- Special windings

Highlights



temperature

Extended Temperature Range

The ZSS stepper motor not only convinces with a very balanced, smooth and low resonance running performance with maximum positioning accuracy, but also with the extended ambient temperature range of -30 to +80 °C.



Options

Variety of expansion stages

With a variety of options and the high level of vertical integration of phytron, the ZSS is the ideal basis for customised applications. Gears, brakes, encoders, shaft or flange adjustments or special windings - the ZSS offers the optimum basis for efficient customising.

Industrial

Stepper motor ZSS 19 to ZSS 57

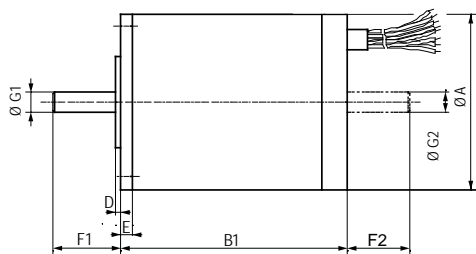

ZSS 19 to 33 with free wire ends

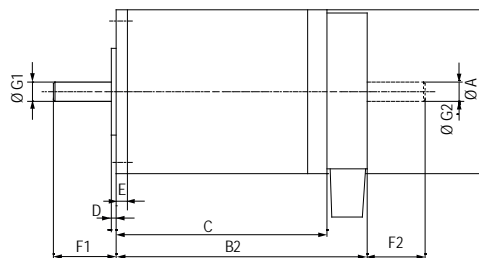

ZSS 41 to 57 with protective cover

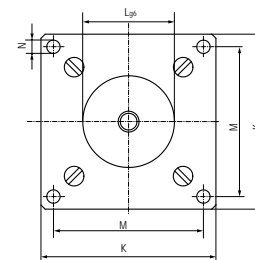

Standard motor flange

Dimensions / Electrical and Mechanical Characteristics

ZSS Standard 200-steps ¹⁾	Electrical Characteristics					Mechanical Characteristics						Dimensions in mm													
	Current/Phase In	Resistance/ Phase	Inductivity/ ³⁾ Phase	max. operating voltage ⁴⁾	AWG	Holding torque ²⁾	Detent torque	Rotor inertia	Loads		Mass	A	B1	B2	C	D	E	F1	F2	G1 ⁵⁾	G2 ⁵⁾	K	L	M	N
									axial	radial															
A	Ω	mH	V _{DC}		mNm	mNm	kg cm ²	N	N	kg															
19.200.0.6 19.200.1.2	0.6 1.2	1.85 0.63	0.55 0.15		28	3.8	0.9	0.0009	3	3	0.04	19	26.5		1	2	7.5	6.5	2.5	2.5	19	10	16	M2.5	
20.200.0.6 20.200.1.2	0.6 1.2	3.45 0.95	1.1 0.4		28	5	1	0.0016	3	3	0.065	19	43		1	2	7.5	6.5	2.5	2.5	19	10	16	M2.5	
25.200.0.6 25.200.1.2	0.6 1.2	3.25 0.95	1.5 0.4		26	13	2	0.0025	5	5	0.07	25	31		1	2.5	9.5	8.5	3	3	25	14	21.5	2.2	
26.200.0.6 26.200.1.2	0.6 1.2	5.85 1.7	3.2 1		26	25	2.2	0.006	5	5	0.11	25	47		1	2.5	9.5	8.5	3	3	25	14	21.5	2.2	
32.200.0.6 32.200.1.2	0.6 1.2	4.5 1.25	5.3 1.2		26	50	3	0.01	5	15	0.15	32	38.5		1	3	11	10	4	4	32	18	27	2.8	
33.200.0.6 33.200.1.2	0.6 1.2	7.5 1.9	9.3 2.2		26	75	3.3	0.018	5	15	0.23	32	57.5		1	3	11	10	4	4	32	18	27	2.8	
41.200.1.2 41.200.2.5	1.2 2.5	1.35 0.27	2 0.4	70	22	100	4	0.025	20	40	0.26	42		49	39	1	3	16	15	5	4	42	22	36	3.2
42.200.1.2 42.200.2.5	1.2 2.5	1.7 0.34	3 0.7		22	140	5	0.045	20	40	0.32	42		64	54	1	3	16	15	5	4	42	22	36	3.2
43.200.1.2 43.200.2.5	1.2 2.5	2.6 0.5	5.2 1.2		22	260	7	0.077	20	40	0.47	42		79	69	1	3	16	15	5	4	42	22	36	3.2
⁴⁾ 52.200.1.2 ⁴⁾ 52.200.2.5	1.2 2.5	2.65 0.6	7 1.6		22	450	13	0.15	25	70	0.65	52		77	65	1.5	3.5	17.5	16	6	4	52	28	44	4.3
⁴⁾ 56.200.1.2 ⁴⁾ 56.200.2.5	1.2 2.5	2.85 1.65	6.7 1.7		22	500	30	0.17	40	80	0.7	56.4		69.1	57.1	1.5	4.5	22	20.5	6.35	6.35	60	38.1	47.15	5.2
⁴⁾ 57.200.1.2 ⁴⁾ 57.200.2.5	1.2 2.5	3.9 0.8	7.8 2.4		22	700	50	0.24	40	80	0.9	56.4		85.1	73.1	1.5	4.5	22	20.5	6.35	6.35	60	38.1	47.15	5.2

¹⁾ Standard 8-lead, motor connection see page 3

²⁾ Holding torque in bipolar mode with parallel windings, two phases on rated current

³⁾ The inductivity values apply for each single winding as well as for parallel connected windings.

⁴⁾ ZSS 52, 56 and 57 with earthing screw on the terminal board.

⁵⁾ Shaft diameter tolerances: ZSS 19 to 26: -0.005 to -0.009; from ZSS 32: g5

⁶⁾ max. operating voltage of the power stage (intermediate circuit voltage)
All values given above refer to room temperature.

Preferred option

Electrical Connection / Connection Types / Phase current

The phytron stepper motors type ZSS are built in 8-lead windings (standard).

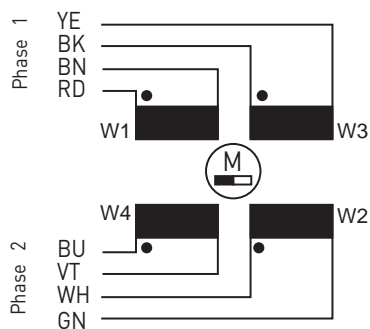

8-lead with free wire ends

Alternative windings such as 4-lead are available on request:

The motors can be used with unipolar or bipolar control mode, as the windings can be differently connected.

5-lead or 6-lead connection are applicable for the unipolar control mode.

In the bipolar control mode, 4-lead motor wiring is required, windings connected in parallel or in series.

The information in the ZSS motor connection leaflet (delivered with each motor) must be regarded when wiring the motor in order to provide for EMC compliant wiring. The motor connection leaflets are also available by down-load from the phytron homepage.

Phase currents

For ZSS phytron stepper motors, the rated current [A] per motor phase is printed on the rating plate. The last digits of the motor's type number define the rated current.

Example: ZSS 32.200.1,2

The rated current is defined for full step operation, at bipolar control mode, with parallel connected motor windings.

According to the connection mode, the motor windings receive different currents. Therefore, for identical power dissipation in the motor, the allowable phase current is determined by the connection mode.

For short time, double current overload is acceptable.

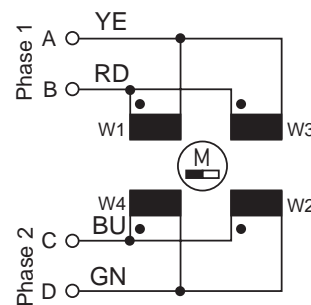

4-lead / parallel windings / bipolar mode

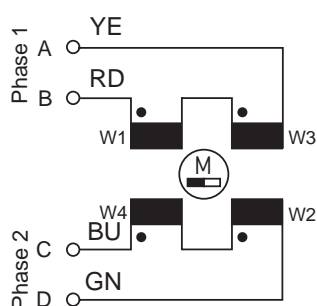

4-lead / serial windings / bipolar mode

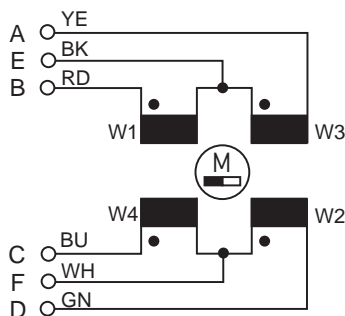

6-lead / unipolar mode

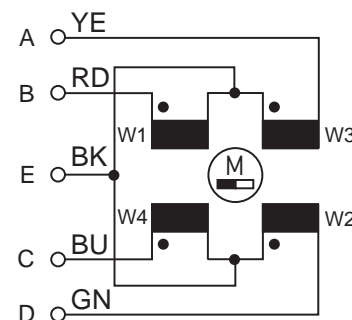

5-lead / unipolar mode

Control mode	Bipolar control mode Full step operation		Unipolar control mode Full step operation	
	4-lead parallel windings	4-lead serial windings	5-lead	6-lead
Motor connection	Rated current	Rated current x 0.5	Rated current x 0.707	Rated current x 0.707
Allowable phase current for identical power dissipation				

Industrial

Option: Stepper Motor with Encoder

The stepper motors ZSS 25 to ZSS 57 with mounted encoder are particularly suitable for use in control actuators or for system monitoring.

- Motor connection by free wire ends
- Encoder connection with flat cable with 10-pin connector
- Protection class IP20

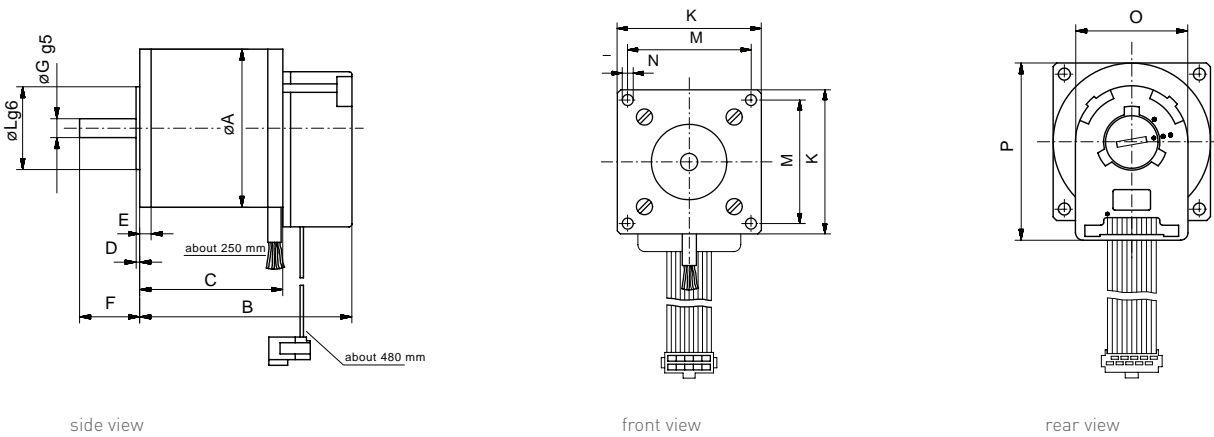

Encoder	Stepper motor	Dimensions in mm												
		A	B	C	D	E	F	G	K	L	M	N	O	P
HEDL 5540	ZSS 25 ZSS 26	25	49.5	31	1	2.5	9.5	3	25	14	21.5	2.2	30	41.1
	ZSS 32 ZSS 33	32	57.5	39	1	3	11	4	32	18	27	2.8	30	42.2
	ZSS 41 ZSS 42 ZSS 43	42	57.5	39	1	3	16	5	42	22	36	3.2	30	47.2
	ZSS 52	52	83.5	65	1.5	3.5	17.5	6	52	28	44	4.3	30	-
	ZSS 56 ZSS 57	56.4	77	58.1	1.5	4.5	22	6.35	60	38.1	47.15	5.2	30	-
		56.4	93	74.1	1.5	4.5	22	6.35	60	38.1	47.15	5.2	30	-

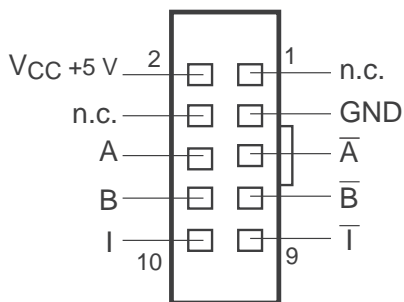

10-pin IDC connector (female)

Technical characteristics of the encoder

- Resolution: 500 increments
- Output current: ± 20 mA
- Output voltage: 0.5 to 2.5 V
- Supply current: 89 mA (30...165 mA)
- Zählfrequenz: 100 kHz
- Supply voltage: 5 V (4.75...5.25 V_{DC})

Option: Stepper Motor with Motor Brake

For the stepper motors ZSS 32 to ZSS 57 a mounted 24 V_{DC} permanent magnet motor brake is optionally available.

ZSS 32 to 43: KEB 01: Power 8 W / Nominal torque 0.4 Nm; electrical connection: free wire ends

ZSS 52 to 57: KEB 02: Power 10 W / Nominal torque 1 Nm; electrical connection: circular connector

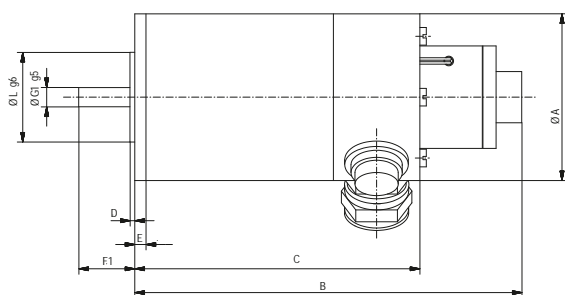

Side view

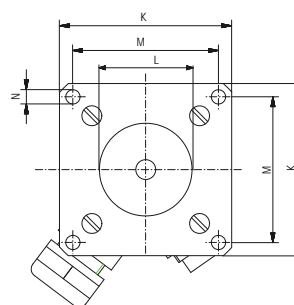

Front view

Motor brake	Stepper motor	Dimensions in mm										
		A	B	C	D	E	F1	G1	K	L	M	N
KEB01	ZSS 32	32	72	43	1	3	11	4	32	18	27	2.8
	ZSS 33	32	91	62	1	3	11	4	32	18	27	2.8
	ZSS 41	42	104	71.5	1	3	16	5	42	22	36	3.2
	ZSS 42	42	124	86.5	1	3	16	5	42	22	36	3.2
	ZSS 43	42	139	101.5	1	3	16	5	42	22	36	3.2
KEB02	ZSS 52	52	121	89	1.5	3.5	17.5	6	52	28	44	4.3
	ZSS 56	56.4	112	79.6	1.5	4.5	22	6.35	60	38.1	47.15	5.2
	ZSS 57	56.4	128	95.6	1.5	4.5	22	6.35	60	38.1	47.15	5.2

Option: Stepper motor with Heat Sink

The ZSS stepper motors are also available with a mounted heat sink. Depending on the motor's mounting position, a heat sink with radial fins (K1) or axial fins (K2) can be selected.

The use of a K1 heat sink increases the stepper motor's thermal dissipation surface by a factor of approx. 3.9. With a K2 heat sink, it is increased by a factor of approx. 3.4.

A heat sink can be mounted subsequently, preferable by phytron.

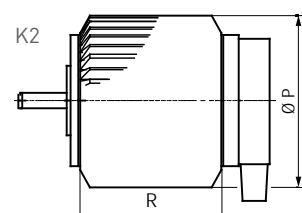
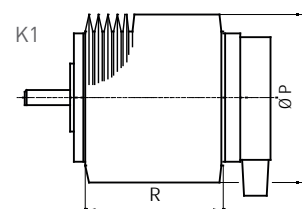

Stepper motor	Dimensions											
	ZSS 19	ZSS 20	ZSS 25	ZSS 26	ZSS 32	ZSS 33	ZSS 41	ZSS 42	ZSS 43	ZSS 52	ZSS 56	ZSS 57
P	26	26	35	35	42	42	55	55	55	65	78	78
R	20.5	37	24	40	30	49	30	45	60	58	44	60

Industrial

Option: Stepper Motor with GPL Low-backlash Planetary Gear

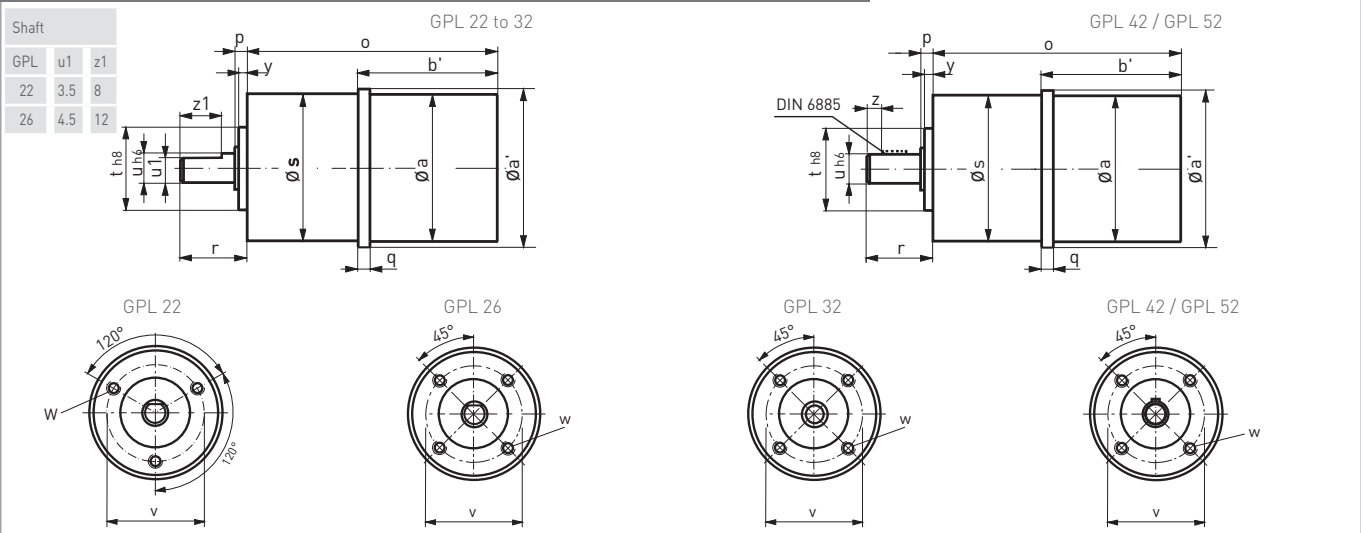

Gaer	Stepper motor	Dimensions in mm																	Mass (motor and gear) in kg			
		a	a'	b'	1-stage	2-sta-	3-stage	o	p	q	r	s	t	u	v	w	x	y	z	Stages		
																				1	2	3
GPL 22	ZSS 19	19	22	29	50	57	64	2.7	4.5	15	22	12	4	16	M2.5x4	-	2	-	0.09	0.115	0.14	
	ZSS 20			45.5	66.5	73.5	80.5												0.115	0.140	0.165	
	ZSS 25	25	25.5	33.5	54.5	61.5	68.5	2.7	5	17	26	14	5	20	M3x4	-	2	-	0.12	0.145	0.17	
	ZSS 26			49.5	70.5	77.5	84.5												0.16	0.185	0.21	
GPL 26	ZSS 25	25	26	33.5	59	67	75	2.7	5	17	26	14	5	20	M3x4	-	2	-	0.14	0.16	0.185	
	ZSS 26			49.5	75	83	91												0.18	0.2	0.225	
GPL 32	ZSS 32	32	33	40.5	69.5	78.5	87.5	3.6	5	20	32	20	6	26	M3x5	-	3	-	0.285	0.330	0.4	
	ZSS 33			59.5	88.5	97.5	106.5												0.365	0.41	0.48	
GPL 42	ZSS 41	42	43	53	88	100.5	113	3.8	7	22.5	42	25	8	32	M4x8	3x3x14	3		0.535	0.61	0.685	
	ZSS 42			68	103	115.5	128												0.595	0.67	0.745	
	ZSS 43			83	118	130.5	143												0.745	0.820	0.895	
GPL 52	ZSS 52	52	53	82.5	123.5	138	152.5	4	9	24	52	32	12	40	M5x8	4x4x16	3	2	1.125	1.25	1.375	
	ZSS 56	56.4	57	73	114	128.5	143												1.175	1.3	1.425	
	ZSS 57			89	130	144.5	159												1.375	1.5	1.625	

Mass / Permissible Loads / Protection Class

Gear	Mass without motor			Perm. radial load (center of shaft)	Permissible axial load	Protection class	Protection class gear + motor
	1-stage	2-stage	3-stage				
	g			N	N		
GPL 22	50	75	100	30	24	IP 44	IP 40 IP 44
GPL 26	70	90	115	50	40	IP 44	IP 40 IP 44
GPL 32	135	180	250	80	65	IP 54	IP 40 IP 44
GPL 42	275	350	425	150	120	IP 54	IP 43 IP 65
GPL 52	475	600	725	250	200	IP 54	IP 43 IP 65

IP xx = Standard IP xx = optional (dimensions on request)

GPL Gear Mechanical Characteristics

Gear	Stepper motor	Mechanical gear characteristics											
		Stages	Reduction ratios		Standard			Low-backlash			Torsional stiffness	Average mass inertia at output	Efficiency (%)
					No-load backlash	Nominal torque (S1)	Emergency stop torque	No-load backlash	Nominal torque (S5)	Emergency stop torque			
					Nm			Nm					
GPL 22	ZSS 19 ZSS 20 ZSS 25 ZSS 26	1	4:1 5:1	7:1	20'	0.1	0.2	-	-	-	0.19	0.008	96
		2	16:1 20:1 28:1	35:1 49:1	35'	0.5	1	-	-	-	0.21	0.006	90
		3	64:1 80:1 112:1	140:1 196:1 245:1	50'	1.5	3	-	-	-	0.2	0.004	85
GPL 26	ZSS 25 ZSS 26	1	3.5:1 4.33:1	6:1 7.67:1	20'	0.3	0.6	-	-	-	0.24	0.012	96
		2	12.25:1 18.78:1 26:1	33.22:1 46:1	35'	1	2	-	-	-	0.26	0.010	90
		3	81.37:1 112.67:1 143.96:1	199.33:1 276:1	50'	3	6	-	-	-	0.25	0.0095	85
GPL 32	ZSS 32 ZSS 33	1	4:1 4.5:1 5.2:1	6.25:1 8:1	20'	0.4	0.8	6'	0.8	1.6	0.3	0.015	96
		2	16:1 18:1 20.8:1 25:1 29:1	32:1 36:1 41.6:1 50:1	35'	2	4	10'	4	6	0.32	0.012	90
		3	72:1 81:1 100:1 130:1	144:1 200:1 225:1 256:1	50'	6	12	15'	6	12	0.3	0.011	85
GPL 42	ZSS 41 ZSS 42 ZSS 43	1	4:1 5:1	6:1	20'	0.7	1.4	6'	1.4	3	0.4	0.03	96
		2	14:1 16:1	20:1	35'	4	8	10'	8	12	0.42	0.024	90
		3	56:1 64:1 80:1 100:1	120:1 144:1 184:1	50'	12	24	15'	12	24	0.4	0.024	85
GPL 52	ZSS 52 ZSS 56 ZSS 57	1	4:1 4.5:1 5.2:1	6.25:1 8:1	20'	1.5	3	6'	3	6	1.2	0.06	96
		2	16:1 18:1 20.8:1 25:1 29:1	32:1 36:1 41.6:1 50.1:1	35'	10	20	10'	20	30	1.3	0.055	90
		3	72:1 81:1 100:1 130:1	144:1 200:1 225:1 256:1	50'	30	60	15'	30	60	1.35	0.05	85

1) Valid for 21 °C ambient temperature

Stepper Motor with GPL Gear

- Stepper motor mounted gear
- 1- to 3-stage planetary gear
- Low gear backlash
 - Standard: 20 to 50 arcmin
 - Low-backlash: 6 to 15 arcmin
- Maximum permanent torque 0.1 to 38 Nm
- 100% permissible short-term overload
- Adapted for permanent, alternate or intermittent operation
- Ideal for combinations with toothed belt modules
- 4:1 to 256:1 reduction ratios (depending on the gear type)
- High efficiency
- Low gear inertia
- Perm. temperature range -30 to +90°C
- Maintenance-free permanent lubrication

Gear Material

- Gear housing
 - GPL16 and 22: stainless steel
 - GPL 26 to 52: rustproof for normal environmental conditions
- Output shaft: 2 deep groove ball bearings

Gear Operating Modes

1: Continous operation

The gear box's operating time exceeds 15 minutes without a break or the duty cycle is more than 60%. In no case the gear box housing temperature may exceed 70 °C.

S5: Cyclical operation

The gear box's duty cycle is less than 60%. The number of operations per hour can range anywhere from a few to several thousand. If the number of operations exceeds 1000 per hour, the maximum torque occurring has to be multiplied by a shock factor to take into account the additional dynamic load. The data in this publication are based on software models and empirical values and on a shock factor of 1.25.

Shock Factor for Cyclical Operation (S5)

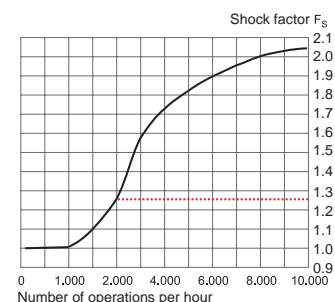

ZSS Stepper motor with HD Gear

The Harmonic Drive gears are based on a totally new operating principle. The transmission force is exerted by a resilient deformable toothed steel cylinder flexspline which transmits the motor rotation to the drive shaft. Drive shaft and output shaft direction is opposed.

Backlash and torsional stiffness

Harmonic Drive® gears have particularly low backlash. In practice, the tooth-contour backlash can be neglected (see page 9). The total gear torsion is equal to the sum of $\frac{1}{2}$ backlash + torque/resilient constant.

HD Gear

- with mounted stepper motor ZSS 25 to ZSS 52
- Reduction ratio depending on size 50:1, 80:1, 100:1
- High reduction ratio in a small volume
- Low weight
- Low mass inertia
- High permissible torque, in comparison to the size
- High drive speed
- Very low backlash in comparison to conventional gears: 0.4 to 4 arcmin
- High efficiency

HD 05 to 14

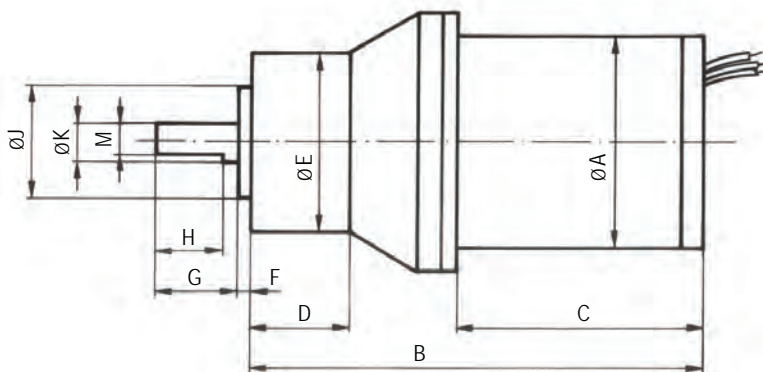

HD 05 to 08

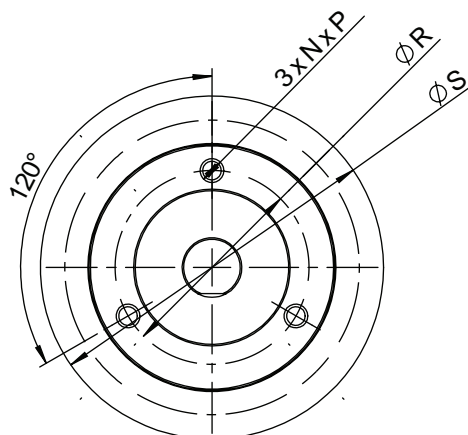

HD 11 to 14

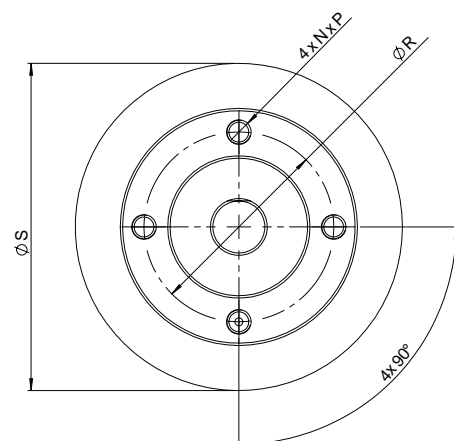

Dimensions and Mechanical Characteristics

Gear	Stepper motor	Dimensions in mm														Mass Motor with gear kg	Reduction ratio	Max. permissible off drive torque Nm	Max. permissible speed 1/min	Massenträgheitsmoment Getriebe ¹⁾ kg cm ²	Max. zulässige Radialkraft N	Max. zulässige Axialkraft N	Zahnflankenspiel min	Federkonstante Nm/in	
		A	B	C	D	E	F	G	H	J	K	M	N	P	R										S
HD 05	ZSS 25 ZSS 26	25	53.9 69.9	28.5 44.5	11.9	20	1	10	9	13.5 _{h6}	5 _{h6}	4.6	M2	6	16.4	32	0.09 0.15	80:1	0.3	9000	2.5 x 10 ⁻⁴	60	30	0.4 - 4	0.023
HD 08	ZSS 32 ZSS 33	32	81.2 100.2	35.5 54.5	26.7	33	1.8	20	18	21 _{h6}	8 _{h6}	7.5	M3	6	26	46	0.28 0.35	50:1 100:1	1.5 2.0	6000	0.003	200	100	0.4 - 4	0.16 0.2
HD 11	ZSS 41	42	99.5	42	30.5	40	3	22	20	24 _{h7}	10 _{h6}	9.5	M4	7.5	34	58	0.53	50:1 100:1	2.5 4.0	5000	0.012	250	200	0.4 - 3	0.3 0.36
	ZSS 42	42	115.5	58	30.5	40	3	22	20	24 _{h7}	10 _{h6}	9.5	M4	7.5	34	58	0.59								
	ZSS 43	42	130.5	73	30.5	40	3	22	20	24 _{h7}	10 _{h6}	9.5	M4	7.5	34	58	0.74								
HD14	ZSS 52	52	136	73.5	41	50	3	25	23	30 _{h7}	12 _{h6}	11.5	M5	11	40	69	1.15	50:1 100:1	5.4 7.8	5000	0.033	400	400	0.4 - 3 0.4 - 2	0.8 0.9

Anmerkungen:
Abmessungen und technische Daten des Motors: siehe Seite 2.
¹⁾Massenträgheitsmoment des Motors: siehe Seite 2.

Tooth-contour-backlash

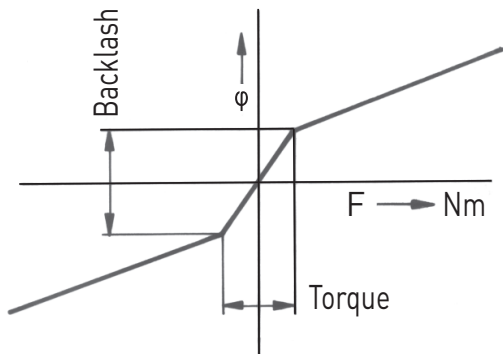

Resilient constant K

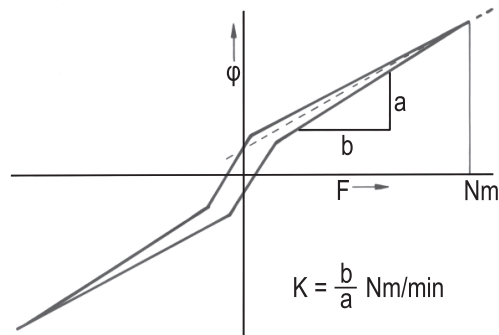

Industrial

Frequency Characteristics

The curves correspond to the limit values of the operational characteristics (M) as a function of the control pulses (frequency/speed), for two different supply voltages (U)

The motor connection type is 4-leads with parallel windings. The motors are controlled by phytron stepper motor power stages in the half-step mode.

Power Characteristics

For each frequency curve, the power characteristic (P) indicates the power delivered by the output shaft.

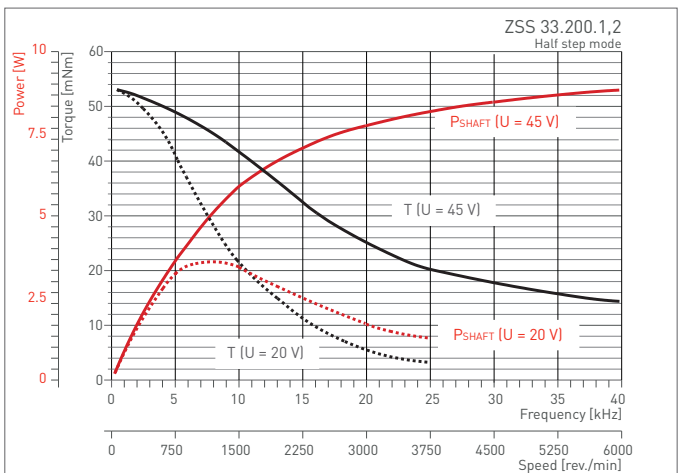
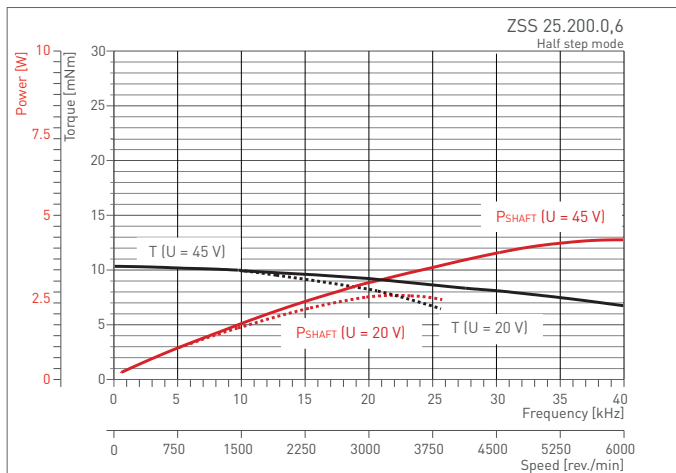
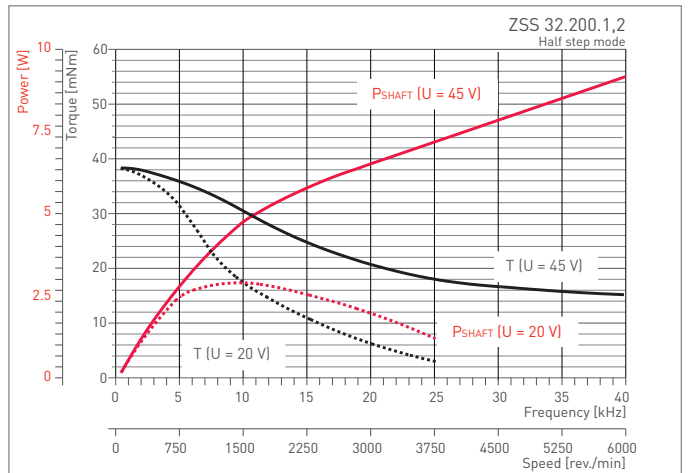
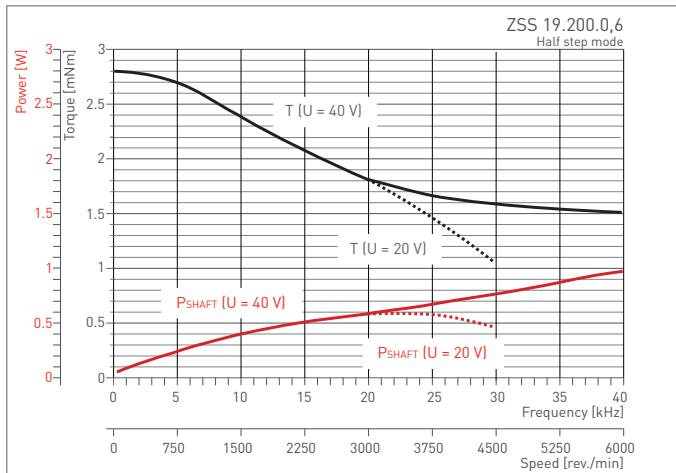
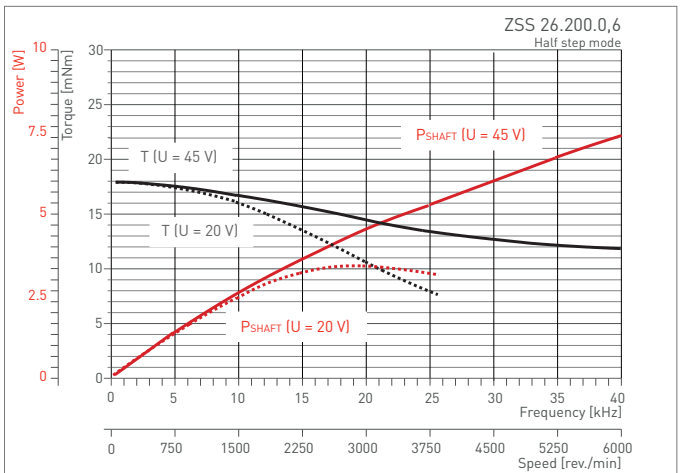

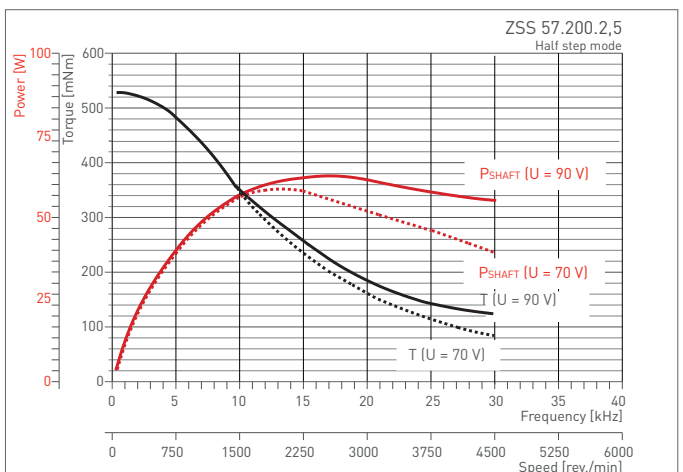
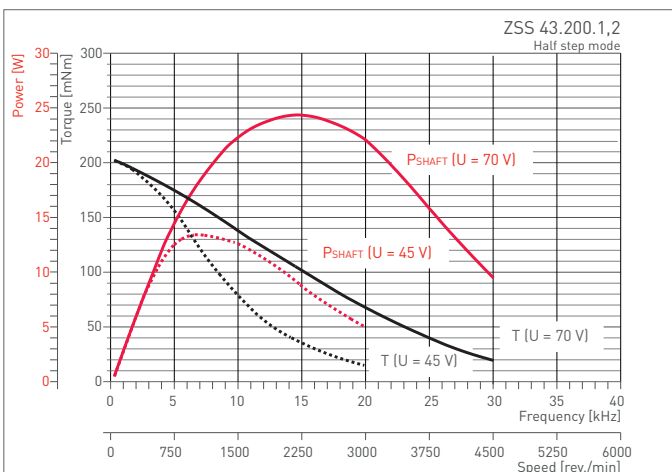
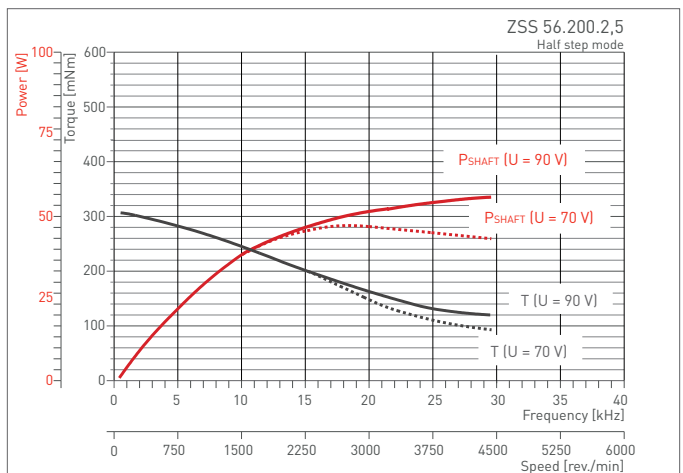
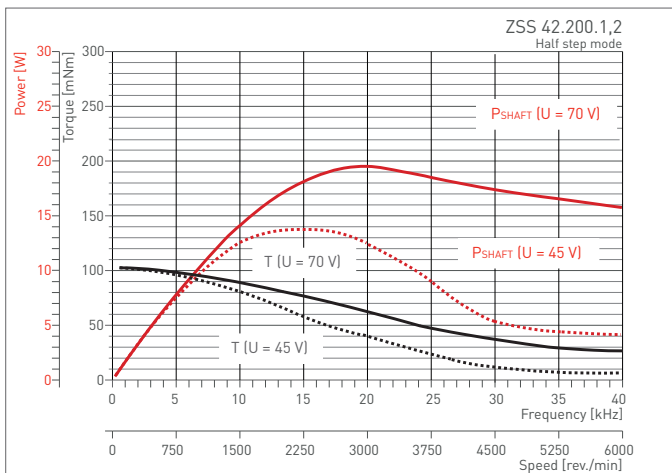
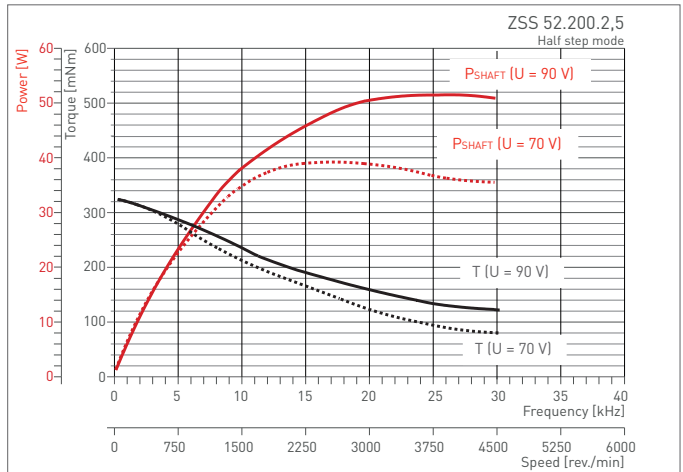
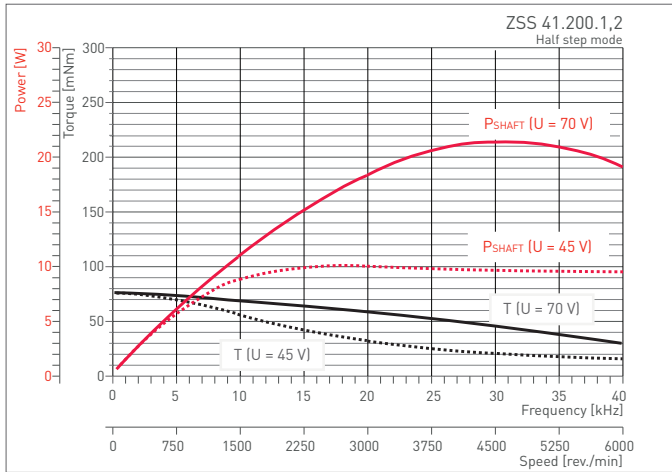

Industrial

Ordering Code

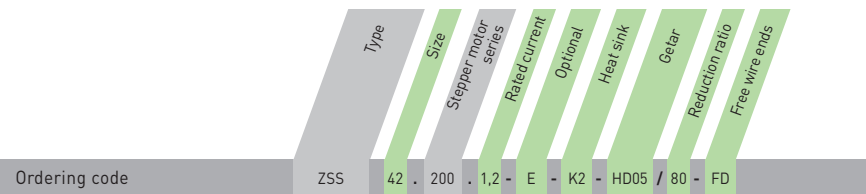

Options	
Size ¹⁾	19, 20, 25, 26, 32, 33, 41, 42, 43, 52, 56, 57
Rated current	0,6 ; 1,2 oder 2,5
Optional	2nd shaft (all types) E Encoder (ZSS 25 to 57) Motor brake (ZSS 32 to 57)
Heat sink	K1 or K2 for ZSS 19 to 57
Gear/reduction ratio	GPL: ZSS 19 to 57 PLG: ZSS 25 to 57 HD: ZSS 25 to 52 GSR: on request
Free wire ends	FD

¹⁾ ZSS 52 to 57: with earthing screw

All illustrations, descriptions and technical specifications are subject to modifications; no responsibility is accepted for the accuracy of this information.

A motor connection leaflet is enclosed to every delivery of stepper motors. PDF files are available for download from the phytron homepage.



ENG

www.phytron.eu/phyBASIC

phyBASIC™

Precision Stepper Motor with High Torque and Smooth Running

Our motor series *phyBASIC™* combines the advantages of a price-optimised design with excellent operating characteristics. That makes the *phyBASIC™* motors particularly suitable for standard applications in the manufacturing industries. Good running performance, high torque and solid craftsmanship make the *phyBASIC™* an excellent choice for environments up to IP 40 when it comes to quick precise positioning tasks. Through the 200-step design, the optimised metal sheet cut and the smooth running the motor is also suitable for high precision applications.

More than just a standard

To help you find the perfect solution for your project, we offer you the opportunity to realise individual changes on the basis of our motor series. If *phyBASIC™* or the VSS in vacuum series is not sufficiently adapted to your application, we will develop one of our motors to the "perfect fit" for your application.

Combined with our modular motion controller *phyMOTION™*, the driver 1-STEP-Drive (for SIMATIC® ET200® S) or our amplifiers you will receive a perfectly tuned system of high quality motors, power amplifiers and controllers. Through a careful selection of suppliers and our certified quality system (ISO 9001), we make sure that *phyBASIC™* motors meet our high quality requirements and can be reliably used together with our electronics. You receive accustomed high phytron quality at good prices - bundled with our excellent support!

With our vast application experience of drives e.g. in paper production or even satellite optics we have the know-how to move your application.

RoHS
compliant

In Focus



high precision



high torque



smooth running

- 2-phase stepper motors
- Holding torques from 16 mNm to 7.2 Nm
- Edge dimension from 20 to 86 mm
- Number of steps (standard) 200
- Step accuracy
5 % for 1.8° stepper motors
- Operating voltage
phyBASIC™ 20,28,42 (NEMA 8,11,17):
48 V_{DC}
phyBASIC™ 56,86 (NEMA 23/34):
72 V_{DC}
- Standard connection: 4-lead parallel
- Protection class IP 40
- Insulation class B, 130 °C
- Insulation resistance 100 MΩ
- Operating temperature range
-10 to +50 °C (non-freezing)
- Cable with mating connector included
- Options
 - Gear
 - Rear shaft

Industrial

Stepper motor *phyBASIC™* 20 to 86 (NEMA 8 to 34)

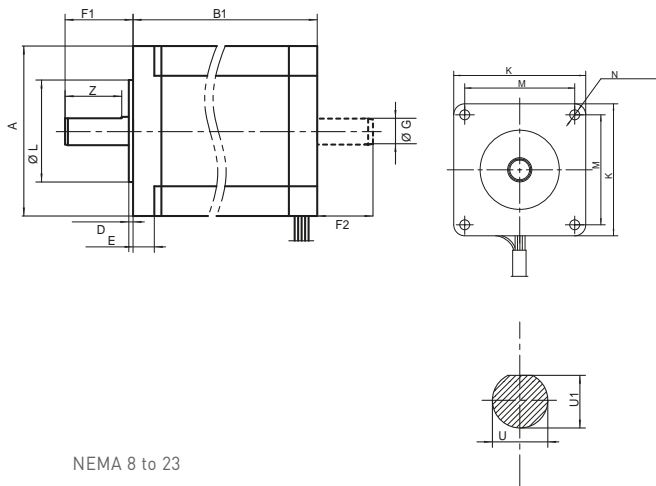

NEMA 8 to 23

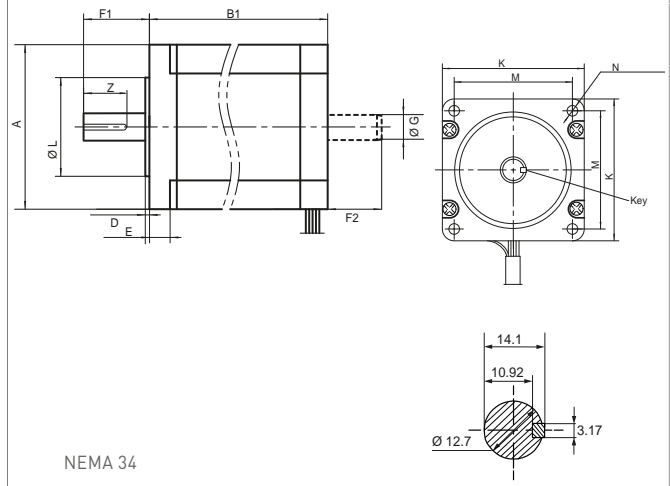

NEMA 34

Dimensions / Electrical and mechanical characteristics

NEMA	Size	Mechanical characteristics										Dimensions in mm														
		Current/Phase	Resistance/Phase	Inductivity/Phase	AWG	max. voltage	Holding torque	Detent torque	Rotor mass inertia	Bearing load		Mass	A ⁷⁾	B1 ⁸⁾	D	E	F1 ⁵⁾	F2 ⁴⁾	G ³⁾	K ⁷⁾	L ⁶⁾	M	N	U ²⁾	U1 ³⁾	Z
										axial ¹⁾	radial															
Edge dim.	Length	A	Ω	mH	V	mNm	mNm	kg cm ²	N	N	kg															
8	20-1	0.6	6.7	1.25	26	48	16	1	0.002	4	20	0.05	20.1	31.5	1.5	-	20	-	-	20.1	15	16	M2	4	-	-
11	28-1	1.0	2.5	2.2	26	48	65	5	0.009	7	52	0.1	28.3	31	2	-	24	-	-	28.3	22	23	M2.5	5	4.5	15
17	42-1	1.5	1.7	2.9	26	48	320	12	0.038	25/65	29	0.21	42.3	34.3	2	-	24	13	5	42.3	22	31	M3	5	4.5	15
17	42-3	1.5	2.2	4.9	26	48	620	25	0.082	25/65	29	0.36	42.3	48.3	2	-	24	13	5	42.3	22	31	M3	5	4.5	15
23	56-2	2.2	1.6	6.9	26	72	1500	45	0.22	40/130	70	0.69	56.4	55	1.6	4.8	20.6	13	6.35	56.4	38.1	47.1	5.1	6.35	5.8	15
23	56-3	2.0	2.3	9.8	26	72	2300	75	0.39	40/130	70	1.0	56.4	77	1.6	4.8	20.6	13	6.35	56.4	38.1	47.1	5.1	6.35	5.8	15
34	86-1	5.0	0.48	4.5	18	72	3800	90	0.95	65/155	220	1.6	86	67.5	1.25	10	31.7	19.05	9.52	86	73	69.6	6.5	12.7	-	22
34	86-2	5.0	0.61	8	18	72	7200	150	1.6	65/155	220	2.7	86	97	1.25	10	31.7	19.05	9.52	86	73	69.6	6.5	12.7	-	22

Valid for 20°C ambient temperature and atmospheric pressure.

¹⁾axial bearing load push / pull ²⁾tolerance: 0/-0.012 ³⁾tolerance: ±0.1 ⁵⁾tolerance: ±1 ⁶⁾tolerance: ±0.5 ⁷⁾tolerance: Nema 8 to 17: 0/-0.052; NEMA 23: ±0.05; NEMA 34: ±0.025

⁸⁾Nema 8 to 23: maximum; Nema 34: tolerance: ±0.5 ⁹⁾maximum

Frequency characteristics

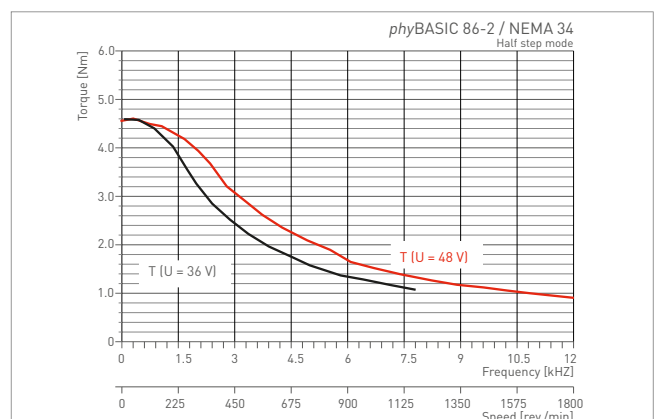
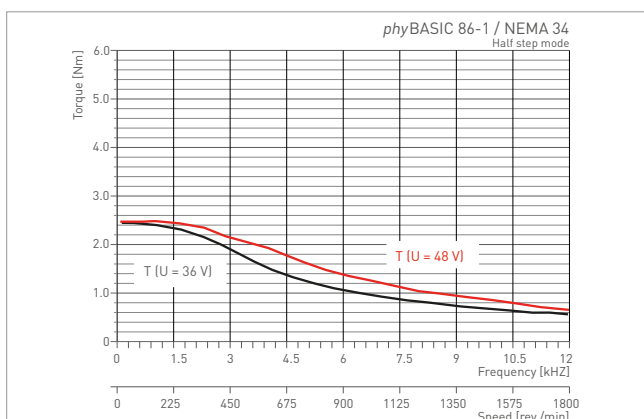
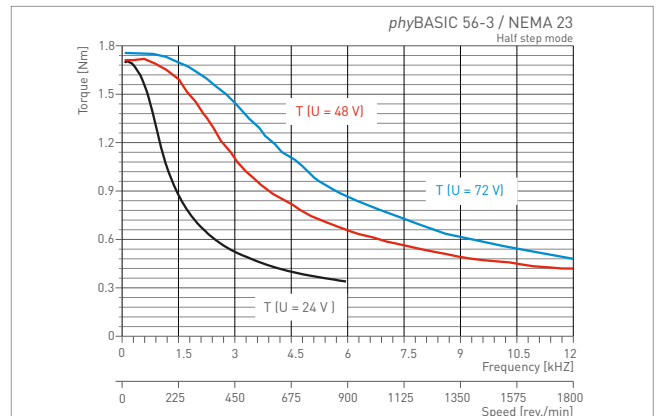
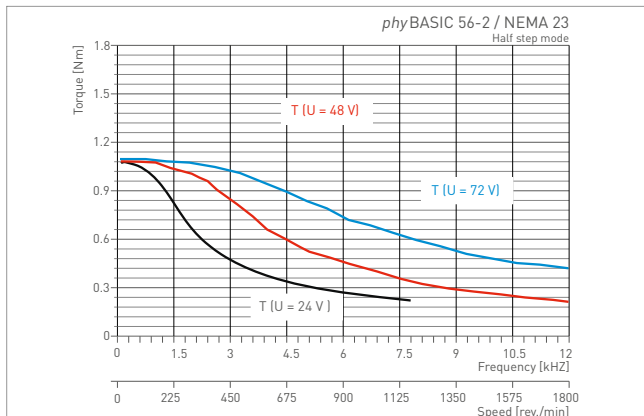
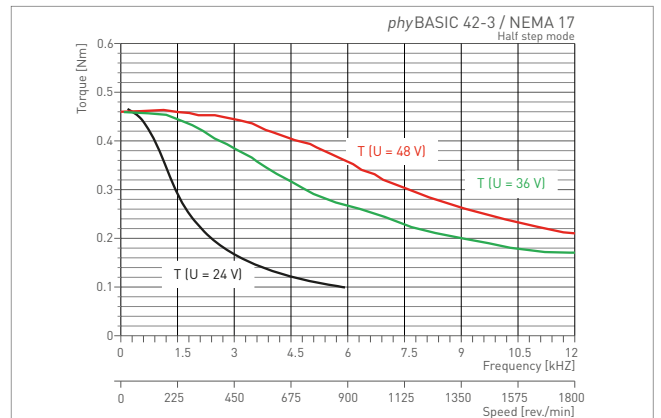
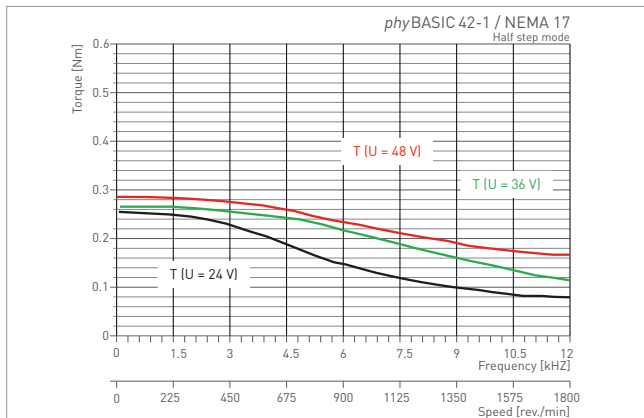
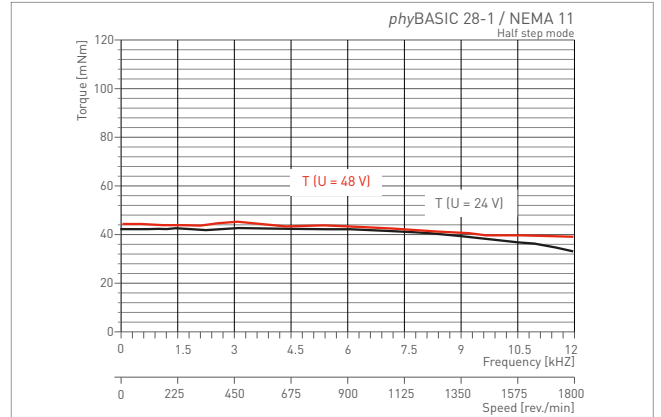
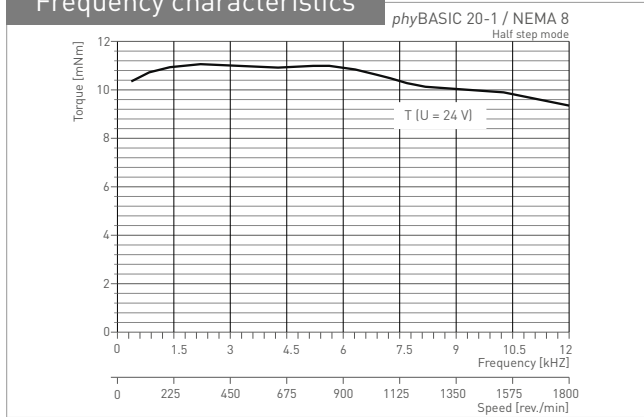

Industrial

Connectors and Mating connectors

Motor	Connector on the motor (pin)	Mating connector	
		Housing	Crimp contact
phyBASIC 20	JST B6B-ZR(LF)(SN)	JST ZHR-6	JST SZH-002T-P0,5
phyBASIC 28	MOLEX 53253-0670	P/N MOLEX 51065-0600	P/N MOLEX 50212-8000
phyBASIC 42	JST S6B-PH-K (LF)(SN)	JST PHR-6	JST SPH-002T-P0,5
phyBASIC 56	JST S6B-XH-A-1 (LF)(SN)	JST XHP-6	JST SXH-001T-P0,6
phyBASIC 86	Wire leads	-	-

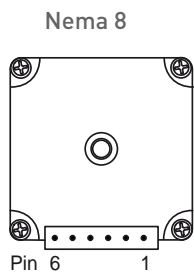

rear view

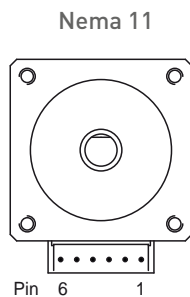

front view

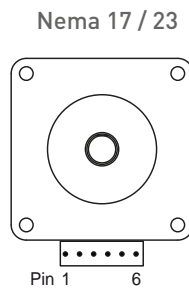

front view

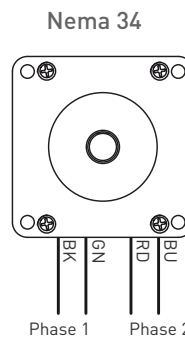

front view

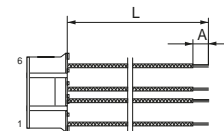

Mating connector JST-300/200

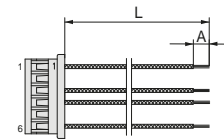

Mating connector MOLEX-300

All illustrations, descriptions and technical specifications are subject to modifications; no responsibility is accepted for the accuracy of this information.

Ordering Code

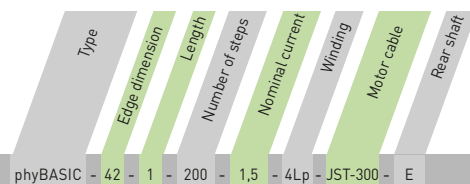

Ordering code example: phyBASIC - 42 - 1 - 200 - 1,5 - 4Lp - JST-300 - E

Options

Edge dimension [mm](NEMA)

- 20 (NEMA 8)
- 28 (NEMA 11)
- 42 (NEMA 17)

56 (NEMA 23)

86 (NEMA 34)

Ordering code

- phyBASIC-20-1-200-0,6-4Lp-JST-200
- phyBASIC-28-1-200-1,6-4Lp-MOLEX-300
- phyBASIC-42-1-200-1,5-4Lp-JST-300
- phyBASIC-42-3-200-1,5-4Lp-JST-300
- phyBASIC-56-2-200-2,2-4Lp-JST-300
- phyBASIC-56-3-200-2,0-4Lp-JST-300
- phyBASIC-86-1-200-5,0-4Lp-300
- phyBASIC-86-2-200-5,0-4Lp-300

Motor connection

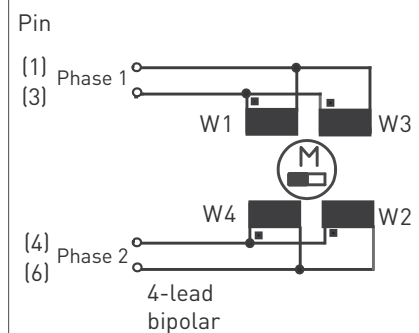

Equipment

- Cable with mating connector included

Phytron GmbH

Industriestraße 12 – 82194 Gröbenzell
 T +49-8142-503-0 F +49-8142-503-190



ENG www.phytron.eu/DMP

DMP 20 / 29 / 37

Inertial damper for stepper motors of size 25 / 32 / 42 (NEMA 11 / 14 / 17)

DMP is an inertial damper for stepper motors. It delivers an excellent performance over a wide frequency because of its specific structure. This minimises settling times in the start-stop operating region and avoids system resonances.

Thus, the DMP prevents not only vibration-induced material fatigue and vibration-induced positioning errors, but also significantly reduces the acoustic noise. If certain perturbances are not adequately compensated for, the motor can lose steps. The resulting loss of torque and precision can drastically affect the application's performance.

phytron's stepper motors run very smoothly due to their construction, hence a damper is

not needed for most precision applications. However, should a Phytron motor operate in a resonance range, the damper is easily deployed to further enhance the motor's characteristics and stability.

Application

Greater requirements for smooth running and precision are often necessary, especially in optics. When moving samples or optics via a joystick, the improvements in the move quality for smoothness, very low acoustic noise and precision are visibly and audibly attained. Accurate and consistent movements with fast settling times of the driven system are significantly improved.

In Focus

- Inertial damper for stepper motors size 25 / 32 / 42 (NEMA 11 / 14 / 17)
- External diameter 20, 29 or 37 mm
- Mounts onto shafts of 2.5; 3; 4; 5 mm or customised
- Materials
 - Allows fitting to aluminium / plastic
 - Stainless steel fixing screws
- Applicable standards
 - Protection class IP 62 (IEC 34)
 - Headless screws for mounting ISO 4027 (DIN 914/A2)
- Environmental conditions
 - Ambient temperature 0 to +60 °C
 - Storage temperature -20 to +70 °C

Decay Process

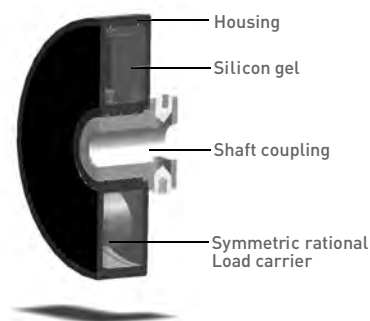
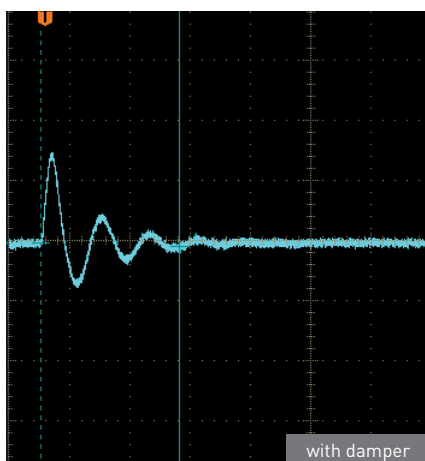
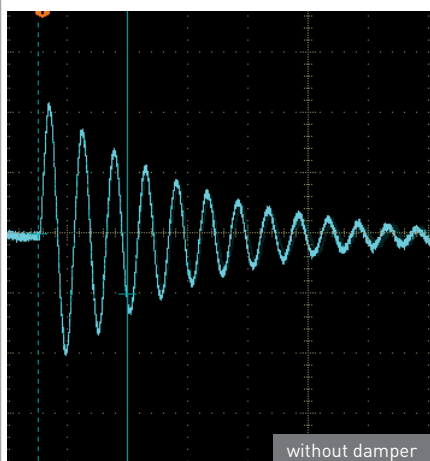

Damper design

Industrial

Characteristics

Damper DMP	Dimensions in mm						Weight in g	Mass inertia in kg cm ²	Headless screws
	B	C	D	E	F	G			
20.2.5	20	11	2.5 0/+0.03	1.5	3	10	7	0.0013	2 x M2
20.3			3 0/+0.03						
29.3	29	11	3 0/+0.03	2	4	12	12	0.006	2 x M2
29.4			4 0/+0.03						
37.4	37	13	4 0/+0.03	2.5	5	14	24.4	0.0205	2 x M3
37.5			5 0/+0.03						

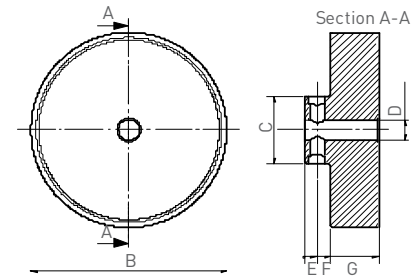

Section drawing

Torque Characteristic

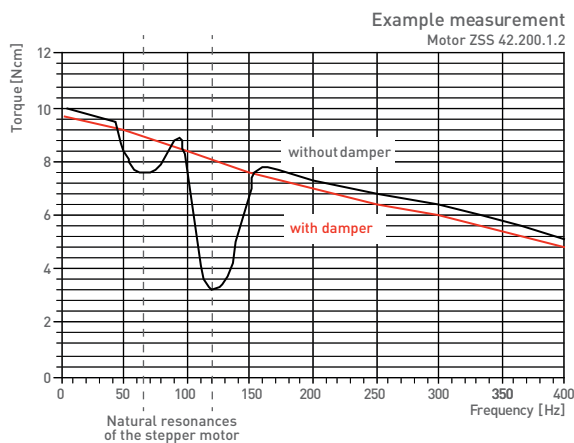

Vibration Characteristic

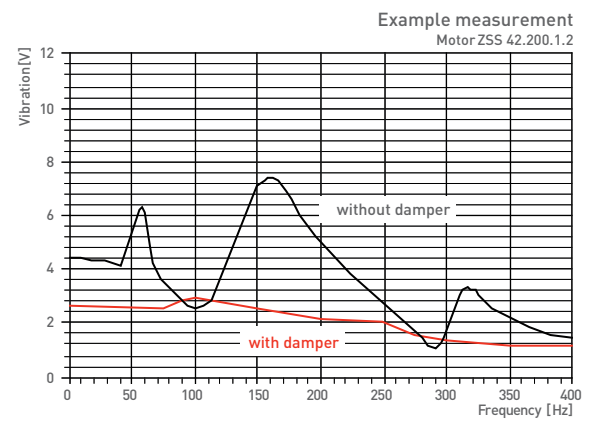

Ordering code

The variable elements of the product are displayed in colour.



Ordering code DMP 37 . 4 . A - X

Options

External diameter [mm]	20 29 37	Motor size 25/NEMA 11 Motor size 32/NEMA 14 Motor size 42/NEMA 17
Motor shaft [mm]	2.5 3 4 5	
Version	A	for standard motors
Application	X	customized

Phytron GmbH

Industriestraße 12 – 82194 Gröbenzell
T +49-8142-503-0 F +49-8142-503-190



ENG

www.phytron.eu/ZSH

HARSH

ZSH Stepper Motor

Robust. Powerful. Reliable.

RoHS
compliant



Phytron's HARSH-Environment motors are particularly suitable for challenging applications in mechanical engineering and industry. Challenging conditions are solved with the precise running performance, high torque and the motor's robust design for environments up to IP68. Inside climate chambers, adjusting the paper thickness in paper machines,

adjusting rotor blades in aviation or directly in a fuel tank: In those and other environments Phytron's stepper motors and controllers for HARSH Environments provide precise and reliable work.

In Focus



high precision



temperature



smooth running

- 2-phase hybrid stepper motor
- Number of steps: 200 / step angle: 1.8°
- Standard version: 4-lead, parallel windings, with terminal box
- Holding torques from 0.45 to 17 Nm
- Protection class: IP 54, optional: IP 68
- Permiss. ambient temperature: -30 to +50 °C (optional: +80 °C) (up to 100 °C for short time)
- Design voltage: 250 V_{AC} acc. to EN 60034
- Insulation class F acc. to VDE 0530
- Test voltage: 1800 V_{AC} (1 sec)
- High permissible axial and radial bearing loads
- Step accuracy: ±3 % (ref. to 1.8° step angle, not cumulative)
- Optional:
 - 2nd shaft (IP 41)
 - Free wire ends (IP 41)
 - Different types of flange and shaft (mm or inch)
 - Motor brake
 - Encoder
 - Low-backlash planetary gear

Highlights

IP68

The ZSH stepper motor convinces with its robust housing with high-strength cable gland. The motor is waterproof up to 10 m with the IP68 option.



temperature

Extended Temperature Range

The ZSH stepper motor not only convinces with a very balanced, smooth and low resonance running performance with maximum positioning accuracy, but also with the optional extended ambient temperature range of -30 to +80 °C (briefly up to 100 °C).



Options

Overview: Extensions

- Stepper motor with brake: Permanent magnet brake for 24 V_{DC} supply
- Stepper motor with encoder: Resolution 50, 200 or 500 lines, 2- or 3-channels
- Stepper motor with encoder and motor brake
- Stepper motor with low-backlash planetary gear: 1-, 2- or 3-stages, Reduction ratios from 3:1 to 512:1

Dimensions Stepper motor ZSH 57 to ZSH 107 / Key / Flange / Shaft

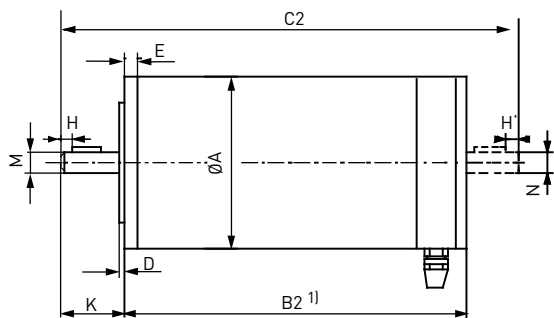

Standard: ZSH with terminal box

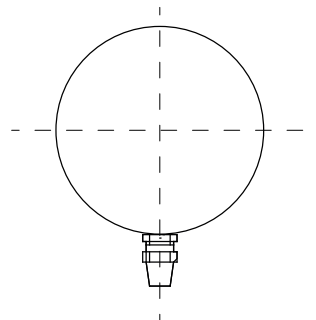

Rear View: Motor with terminal box

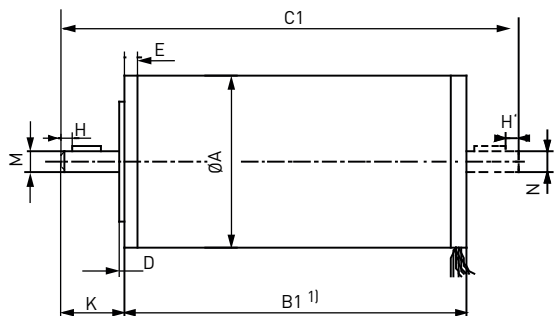

Option: ZSH Stepper motor with free wire ends

¹⁾Required space for terminal box cover fixing screws: up to 2 mm

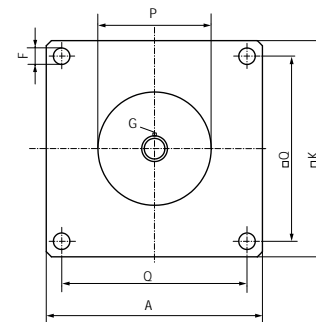

Standard flange

Stepper motor	Dimensions									Key			Flange and shaft:				Flange and shaft:				
	A	± 0.5 B1	±0.5 B2	C1	C2	D	E	F	±0.5 K	G	H	H'	-0.02 M	-0.02 N	-0.05 P	Q	-0.02 M	-0.02 N	-0.05 P	Q	
	mm									mm			mm				mm (inch)				
ZSH 57/1	56.5	50	76	90	108	1.5	5	5.3	21	1)							6.35	6.35	38.1	47	
ZSH 57/2	56.5	76	102	116	134	1.5	5	5.3	21		6.35	6.35	38.1	47							
ZSH 57/3	56.5	104	130	144	162	1.5	5	5.3	21		6.35	6.35	38.1	47							
ZSH 87/1	86	60.5	85.5	137	137	1.5	5.7	6.5	31.5	up to Ø10: A3x3x15	6	1.5	10	10	73	70	9.52	9.52	73	70	
ZSH 87/2	86	92.5	117.5	169	169	1.5	5.7	6.5	31.5	from Ø12: A4x4x15			12	12	73	70	9.52	9.52	73	70	
ZSH 87/3	86	124.5	149.5	201	201	1.5	5.7	6.5	31.5	from Ø12: A4x4x15			12	12	73	70	9.52	9.52	73	70	
ZSH 88/1	86	68.5	93.5	145	145	1.5	5.7	6.5	31.5	up to Ø10: A3x3x15	6	1.5	12	12	73	70	9.52	9.52	73	70	
ZSH 88/2	86	100.5	125.5	177	177	1.5	5.7	6.5	31.5	from Ø12: A4x4x15			12	12	73	70	9.52	9.52	73	70	
ZSH 88/3	86	132.5	157.5	209	209	1.5	5.7	6.5	31.5	from Ø12: A4x4x15			12	12	73	70	9.52	9.52	73	70	
ZSH 107/1	108	89.5	111	-	170	1.5	9	8.5	32	A5x5x20	5	5	12	10	60	90	12.7	12.7	55.54	88.9	
ZSH 107/2	108	139.5	161	-	238	1.5	9	8.5	50				16	10			15.87	15.87	12.7	55.54	88.9
ZSH 107/3	108	189.5	211	-	288	1.5	9	8.5	50				16	12			15.87	15.87	12.7	55.54	88.9
ZSH 107/4	108	239.5	261	-	338	1.5	9	8.5	50				16	12			15.87	15.87	12.7	55.54	88.9

blue = standard version

¹⁾ Optional for size 57: Woodruff key 2x2.6 DIN 6888

Mechanical and Electrical Characteristics ZSH 57 to ZSH 107

Stepper motor type	Phase current bipolar ^{2a)}	Phase current unipolar ^{2a)}	Resistance per winding ^{3a)}	Inductivity per winding ^{2a)}	Holding torque ¹⁾	Detent torque	Rotor mass inertia	Permissible bearing load		Mass
								axial	radial	
	A	A	Ω	mH	Nm	Nm	10 ⁻⁴ kg m ²	N	N	kg
ZSH 57/1	1.4 / 4.2 / 5.5	1 / 3 / 3.9	5.5 / 0.7 / 0.5	9 / 1 / 0.64	0.45	0.01	0.125	80	150	0.6
ZSH 57/2	2.1 / 2.8 / 4.2	1.5 / 2 / 3	4.1 / 2.6 / 1.1	9 / 5 / 2.6	0.85	0.017	0.25	80	150	1
ZSH 57/3	2.1 / 4.2 / 6.5	1.5 / 3 / 4.6	4.3 / 1.6 / 0.8	9 / 3 / 1.2	1.25	0.025	0.375	80	150	1.35
ZSH 87/1	2.3 / 4.2 / 7	1.6 / 3 / 5	3 / 0.8 / 0.3	6 / 1.6 / 0.7	1.8	0.026	0.65	180	280	1.7
ZSH 87/2	5 / 6.5 / 8.4	3.5 / 4.6 / 6	0.8 / 0.5 / 0.3	3 / 1.5 / 1	3.6	0.05	1.3	180	280	2.65
ZSH 87/3	5 / 8.4 / 10	3.5 / 6 / 7	1.1 / 0.5 / 0.4	5 / 1.7 / 1	5.4	0.08	1.95	180	280	3.65
ZSH 88/1 ¹⁾	2 / 4 / 8	-	1.88 / 0.5 / 0.13	11.1 / 2.5 / 0.75	3	0.042	1.35	180	280	1.7
ZSH 88/2	2 / 4 / 8	-	3.61 / 0.74 / 0.21	26 / 5.5 / 1.5	6	0.08	2.7	180	280	2.65
ZSS 88/3	4 / 8 / 12	-	1.14 / 0.29 / 0.14	10.9 / 2.6 / 1	9	0.13	4.05	180	280	3.65
ZSH 107/1	7 / 8 / 12.5	5 / 5.7 / 8.8	0.3 / 0.2 / 0.1	1.6 / 1.2 / 0.55	5	0.11	4	400	650	4.3
ZSH 107/2	8 / 10 / 12.5	5.7 / 7.1 / 8.8	0.4 / 0.3 / 0.2	2.4 / 1.6 / 1.15	9	0.21	8	400	650	7.2
ZSH 107/3	10 / 12.5	7.1 / 8.8 / -	0.4 / 0.3	2.7 / 1.9 / -	13	0.3	12	400	650	9.8
ZSH 107/4	12.5	8.8	0.4	2.7	17	0.4	16	400	650	12.5

blue=popular types¹⁾ Size 88 for bipolar operation only²⁾ Standardwicklung 1/2/3³⁾ The current value given in the ordering data (e. g. ZSH 107/2.200.8) refers to the bipolar mode (parallel windings).⁴⁾ Current in unipolar mode = 0.7 x current in bipolar mode⁵⁾ Resistance per phase in bipolar mode = 0.5 x resistance per winding⁶⁾ The inductivity values apply for each single winding as well as for two parallel windings.
For series mounted windings, the inductivity is multiplied by 4.

Elektrischer Anschluss / Schaltungsarten / Phase current

The phytron stepper motors type ZSH are built in 4-lead parallel windings (standard).

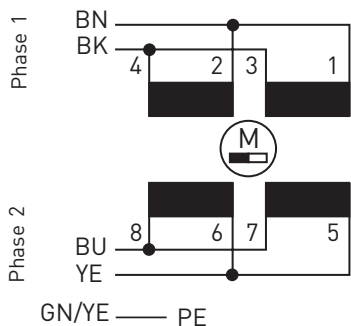

4-lead parallel / winding bipolar

Terminal Box

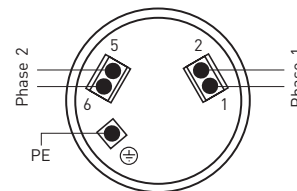

ZSH 57 4-lead parallel

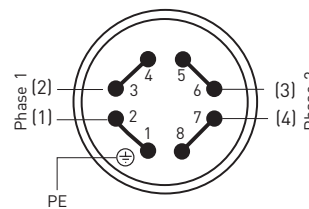

ZSH 87/88/107 4-lead parallel

Alternative windings like 8-lead are available on request:

The motors can be used with unipolar or bipolar control mode, as the windings can be differently connected.

5-lead connection is applicable for the unipolar control mode.

In the bipolar control mode, 4-lead motor wiring is required, windings connected in parallel or in series.

The information in the ZSS motor connection leaflet (delivered with each motor) must be regarded when wiring the motor in order to provide for EMC compliant wiring. The motor connection leaflets are also available by down-load from the phytron homepage.

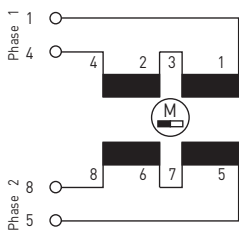

4-lead / serial windings / bipolar

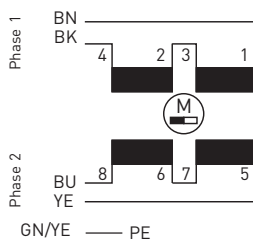

4-lead / free wire ends / serial windings / bipolar

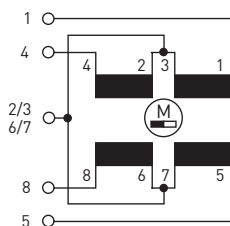

5-lead / unipolar mode

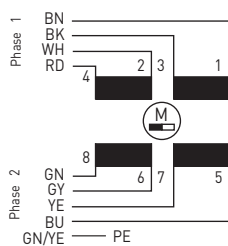

8-lead / free wire ends

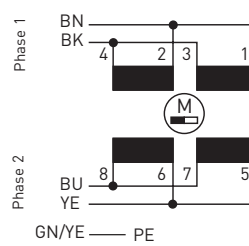

4-lead / free wire ends / parallel windings / bipolar

Dimensions ZSH Stepper Motor with Brake / Encoder

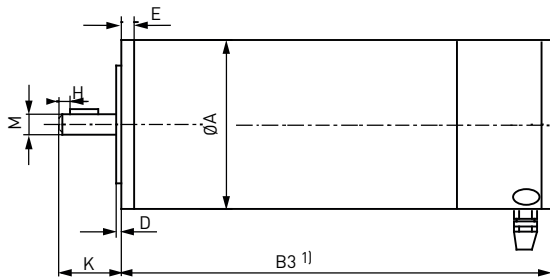

Optional: ZSH Stepper motor with brake

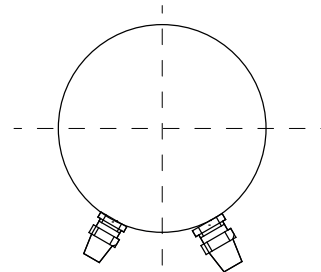

Rear view: Motor with brake/encoder

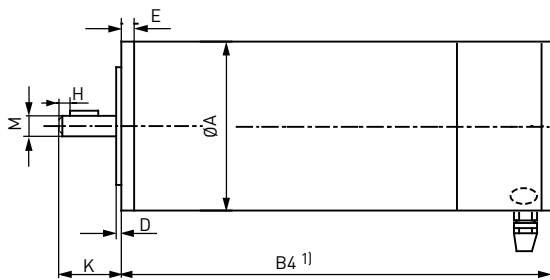

Optional: ZSH Stepper motor with encoder

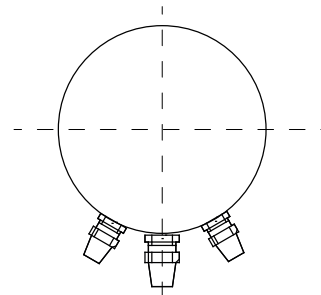

Rear view: Motor with encoder and brake

¹⁾Required space for terminal box cover fixing screws: up to 2 mm

Dimensions Stepper Motor / Brake / Encoder

Stepper motor	Ø Motor	ZSH + KEB	ZSH + E50	ZSH + H200/500	ZSH + KEB + E50	ZSH + KEB + H200/500	C1	C2	D	E	F	K
	A	B3	B4	B5	B6	B7						
ZSH 57/1	56.5	116	88	98	128	137.5	90	108	1.5	5	5.3	21
ZSH 57/2	56.5	142	114	124	154	163.5	116	134	1.5	5	5.3	21
ZSH 57/3	56.5	170	142	152	182	191.5	144	162	1.5	5	5.3	21
ZSH 87/1	86	131	85.5	104	131	153	137	137	1.5	5.7	6.5	31.5
ZSH 87/2	86	163	117.5	136	163	185	169	169	1.5	5.7	6.5	31.5
ZSH 87/3	86	195	149.5	168	195	217	201	201	1.5	5.7	6.5	31.5
ZSH 88/1	86	139	93.5	112	139	161	145	145	1.5	5.7	6.5	31.5
ZSH 88/2	86	171	125.5	144	171	193	177	177	1.5	5.7	6.5	31.5
ZSH 88/3	86	203	157.5	176	203	225	209	209	1.5	5.7	6.5	31.5
ZSH 107/1	108	161	111	136	161	193	-	170	1.5	9	8.5	32
ZSH 107/2	108	211	161	186	211	243	-	238	1.5	9	8.5	50
ZSH 107/3	108	261	211	236	261	293	-	288	1.5	9	8.5	50
ZSH 107/4	108	311	261	286	311	343	-	338	1.5	9	8.5	50

Dimensions in mm

Metric Cable Glands

Dimensions in mm	Cable Ø	Wrench size
Stepper motor connection	9-13	22
Encoder connection	5-9	17
Motor brake connection	5-9	17

- For shielded cables
- Material: nickel plated brass
- Protection class: IP 68 up to 5 bar
- Nitril rubber sealing rings
- Nitril rubber O-ring on external thread
- Test standard EN 50262 / UL 514B

Dimensions in mm

ZSH Stepper motor with integrated encoder

In non disturbed operation the stepper motor runs synchronously to the pulses coming from the controller, that means the motor rotation (= rotation of the rotor) runs synchronously to the pulse frequency (= rotating stator field in the motor). In case of an extreme load at the motor (e.g. via a static load at the motor shaft or by accelerating of the motor) the step frequency of the motor will shortly differ from the pulse frequency within a certain maximum range. This results in changing the load angle (= difference between the real position of the rotor and its target position). For applications homing mode for monitoring the motor movement, we recommend to use a motor with an integrated encoder.

ZSH Stepper motor with integrated encoder E50



The encoder series E50 monitors the motion of the motor. Together with a phytron controller (e.g. MCC- or *phyMOTION*[®] series) the load angle of the stepper motor can be controlled and monitored. When the max. admissible load angle is exceeded (e.g. when the motor run is breaking down) the control unit will create an error signal.

Special Characteristics

- Simple and robust low cost version
- no changes of the motor dimensions in comparison to the standard version with cast connection box (except ZSH 56)
- the encoder is integrated in the motor housing
- available up to protection class IP68
- all requirements for mechanical and climatical ambient conditions (vibration-, shock resistance, temperature and humidity) are fulfilled.
- evaluation of the encoder signals and realisation of a step angle control with generating an error signal can be done by using a phytron controller of the MCC or *phyMOTION*[®] series.

Electrical Characteristics

Supply voltage	5 to 24 V _{DC}
Current consumption	typ. approx. 35 mA (no load at outputs) max. load at outputs 100 mA / output
Operating temperature	-40 to 125 °C

Outputs

2 x 50 pulses per revolution – signals A and B with rectangular shape and inverted signals \bar{A} and \bar{B}

duty cycle 1:1 ± max. 20 % error

bipolar – switching to VCC and GND

short circuit protected signals against GND

RS422 line driver [26LS31]

pulse frequency min. 20 kHz

Signal outputs

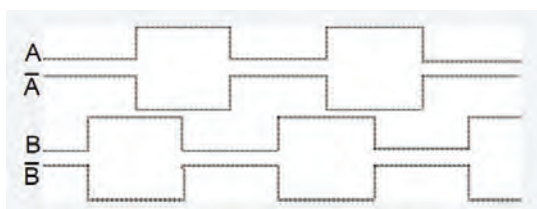

Connection

connection via screw terminals for nominal cross section max. 1mm² [26 -16 AWG]

optionally also available with connector

dimensions as standard motor types! - exception: ZSH 56: see table page 5

ZSH Stepper motor with integrated encoder H200 and H500



The H200 and H500 is characterized by its high resolution; H200 with 2x200 pulse per revolution and the H500 with 2x500 pulse per revolution. It fulfills as an extremely robust encoder also the high requirements for mechanical and climatic environmental conditions (vibration, shock, shock resistance, temperature and humidity).

Special Characteristics

- optical encoder
- the encoder is integrated in the motor housing.
- available up to protection class IP68
- all requirements for mechanical and climatic ambient conditions (vibration-, shock resistance, temperature and humidity) are fulfilled
- evaluation of the encoder signals and realisation of a step angle control with generation of an error signal can be done by using a phytron controller of the MCC or *phyMOTION*® series

Technical Characteristics

Optical encoder	
Supply voltage	5 V _{DC}
Operating temperature	-40 to 100 °C

Outputs

2 x 200 pulse per revolution for H200
2 x 500 pulse per revolution for H500
rectangular shape signals A and B, with inverted signals \bar{A} and \bar{B}
H200 and H500: zero pulse and inverted zero pulse - 1 pulse per revolution
duty cycle 1:1 +max. 10 % error
RS422 line driver (26LS31)
short circuit protected signals against GND
pulse frequency min. 100 kHz

Signal outputs

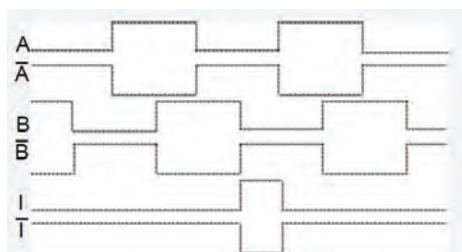

Dimensions

the modified dimensions – compared to the standard motors ZSH without encoder – can be found in the table on page 5.

Connection

connection via screw terminals for nominal cross section max. 1 mm ² (26 - 16 AWG)
optionally also available with connector

Harsh

Stepper Motor ZSH 57 / 87 / 88 / 107 with PLE Planetary Gear

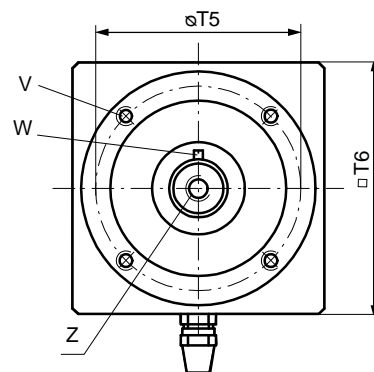
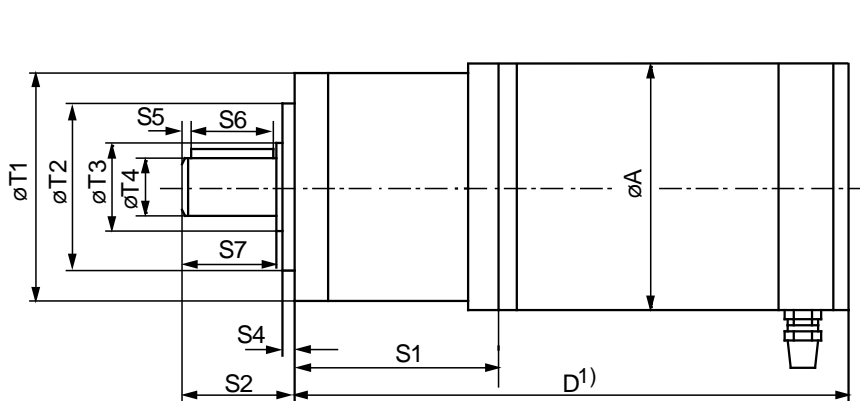

1) Required space for terminal box cover fixing screws: up to 2 mm

W: Key DIN 6885 T1, type A
Z: Centering bore DIN 332, type DS

Dimensions Stepper Motor with Gear

Gear	Stages	Dimensions in mm																			
		A	Total length gear/motor with terminal box				S1	S2	S4	S5	S6	S7	T1	T2	T3	T4	T5	T6	V	W	Z
PLE 60	1 2 3	56.5	ZSH 57/1	ZSH 57/2	ZSH 57/3		55	35	3	2.5	25	30	60	40	17	14	52	60	M5 x 8	5 x 5 x 25	M5 x 12
			131	157	185		67														
			143	169	197		80														
PLE 80	1 2 3	86	ZSH 87/1	ZSH 87/2	ZSH 87/3		72	40	3	4	28	36	80	60	25	20	70	86	M6 x 10	6 x 6 x 28	M6 x 16
			157.5	189.5	221.5		89														
			174.5	206.5	238.5		106.5														
	1 2 3		ZSH 88/1	ZSH 88/2	ZSH 88/3		72	40	3	4	28	36	80	60	25	20	70	86	M6 x 10	6 x 6 x 28	M6 x 16
			165.5	197.5	229.5		89														
			182.5	214.5	246.5		106.5														
PLE 120	1 2 3	108	ZSH 107/1	ZSH 107/2	ZSH 107/3	ZSH 107/4	131.5	55	4	5	40	50	115	80	35	25	100	115	M10 x 16	8 x 7 x 40	M10 x 22
			242.5	292.5	342.5	392.5	158.5														
			269.5	319.5	369.5	419.5	185.5														
			ZSH 107/1	ZSH 107/2	ZSH 107/3	ZSH 107/4	296.5														

Motor/Gear Output Torque

The output torque of the motor/gear combination can be calculated as follows: Motor torque at the required speed (see frequency characteristics) multiplied with reduction ratio and gear efficiency.

Mechanical Characteristics: Motor with PLE				
Gear	Stages	Reduction Ratio	Permissible gear output torque	Mass inertia (without motor) ¹⁾
			Nm	10 ⁻⁴ kg m ²
			ZSH 57	
PLE 60	1	3:1	28	6.5
		4:1	38	3.3
		5:1	40	2.2
		8:1	18	1.2
	2	9:1	44	7.2
		12:1	44	7
		15:1	44	2.4
		16:1	44	3.4
		20:1	44	2.4
		25:1	40	2.3
		32:1	44	1.2
		40:1	40	1.2
3	64:1	18	1	
	60:1	44	2.4	
	80:1	44	2.4	
	100:1	44	2.4	
	120:1	44	1.2	
	160:1	44	0.1	
	200:1	40	0.1	
	256:1	44	0.1	
320:1	40	0.1		
512:1	18	0.1		
			ZSH 87	
PLE 80	1	3:1	85	63
		4:1	115	25
		5:1	110	14
		8:1	50	8
	2	9:1	130	63
		12:1	120	26
		15:1	110	62
		16:1	120	25
		20:1	120	15
		25:1	110	15
		32:1	120	8
		40:1	110	8
3	64:1	50	6	
	60:1	110	25	
	80:1	120	18	
	100:1	120	15	
	120:1	110	60	
	160:1	120	8	
	200:1	110	8	
	256:1	120	8	
320:1	110	6		
512:1	50	6		
			ZSH 87	
			ZSH 107	
PLE 120	1	3:1	115	2.6
		4:1	155	1.79
		5:1	195	1.63
		8:1	120	1.32
	2	9:1	210	2.62
		12:1	260	2.56
		15:1	230	2.53
		16:1	260	1.75
		20:1	260	1.5
		25:1	230	1.49
		32:1	260	1.3
		40:1	230	1.3
3	64:1	120	1.3	
	60:1	260	2.57	
	80:1	260	1.5	
	100:1	260	1.5	
	120:1	230	2.5	
	160:1	260	1.3	
	200:1	230	1.3	
	256:1	260	1.3	
320:1	230	1.3		
512:1	120	1.3		

blue=popular type ¹⁾ Mass inertia referred to motor shaft

PLE Planetary Gear							
Gear	Stages	Torsional stiffness	Absolute backlash	Efficiency	Mass without motor	Maximum axial load ²⁾	Maximum radial load ²⁾
		Nm/arcmin	angular minutes	% (approx.)	kg	N	N
PLE 60	1	2.3	<20	96	0.65		
	2	2.5	<25	94	0.82	600	500
	3	2.5	<30	90	1		
PLE 80	1	6	<12	96	1.6		
	2	6.5	<17	94	2.2	1200	950
	3	6.3	<22	90	2.8		
PLE 120	1	12	<8	96	6.5		
	2	13	<12	94	9	2800	2000
	3	12	<16	90	11.5		

²⁾ referred to center of output shaft

PLE Planetary Gear

- Low-backlash / high efficiency
- Torque shaft bearing: ball bearing
- Lifetime lubrication
- Recommended operation temperature range: -25 to +90 °C
- Mounting position: any
- Standard protection class: IP 54
- Optional: protection class: IP 65
- These gears are specially sealed. Output shaft and keyway are made of stainless steel.
- Angled gears on request

Frequency Characteristics

The curves correspond to the limit values of the operational characteristics (T) as a function of the control pulses (frequency/speed), for two different supply voltages (U). The motor connection type is 4-leads with parallel windings. The motors are controlled by phytron stepper motor power stages in the half-step mode.

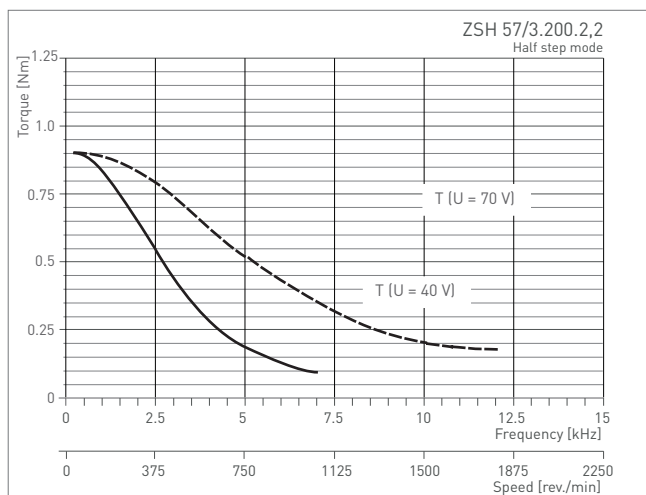
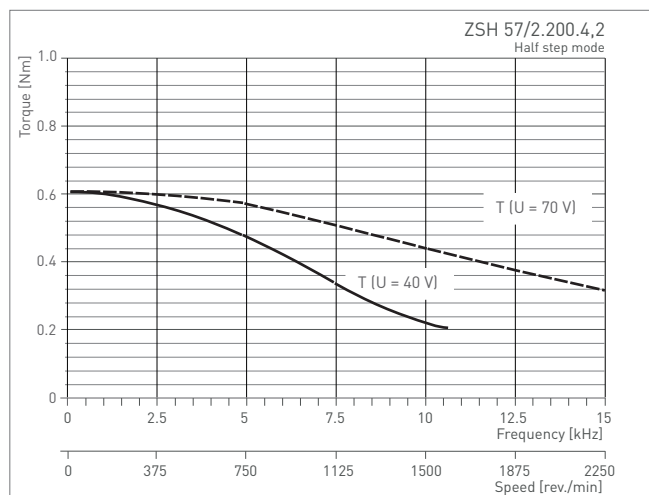
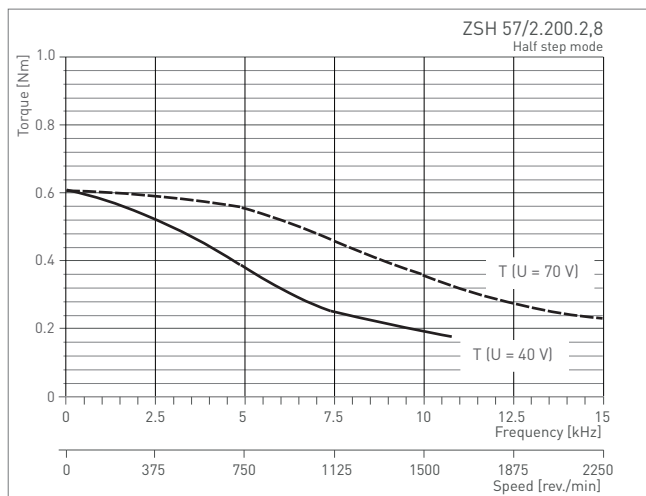
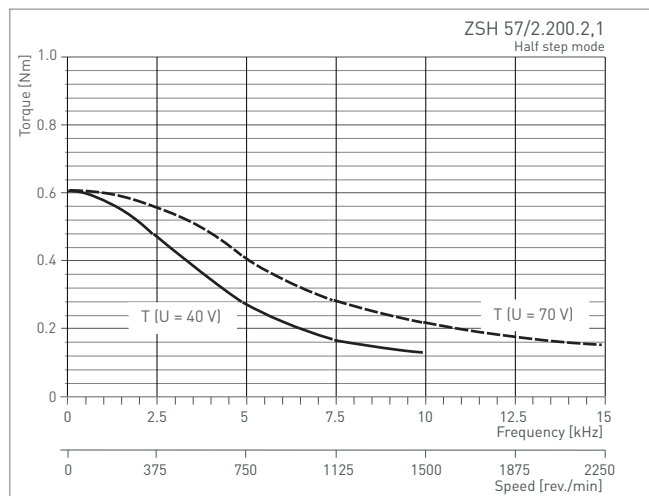
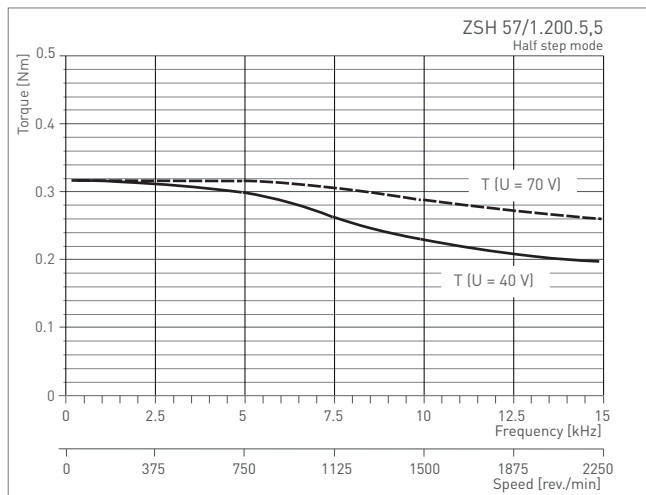
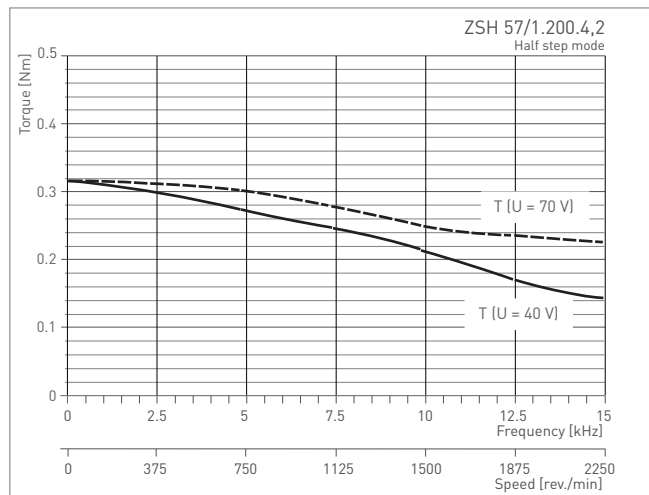

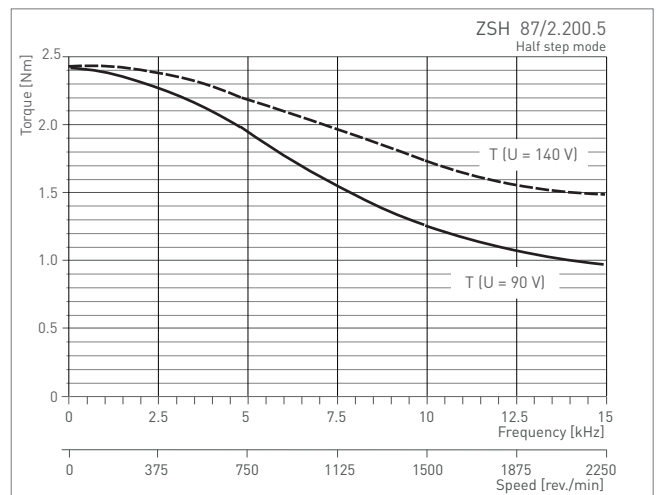
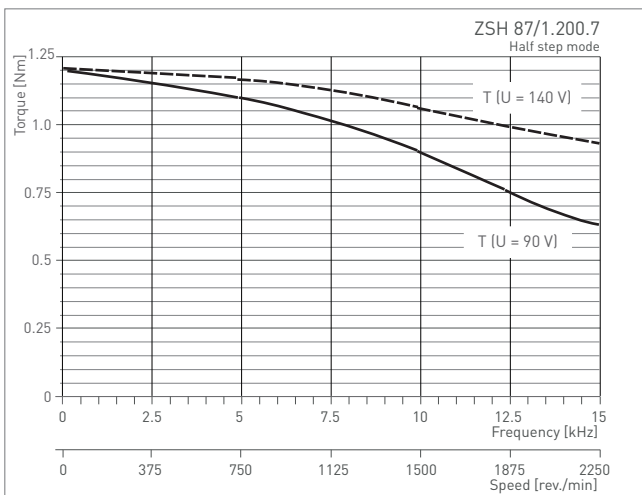
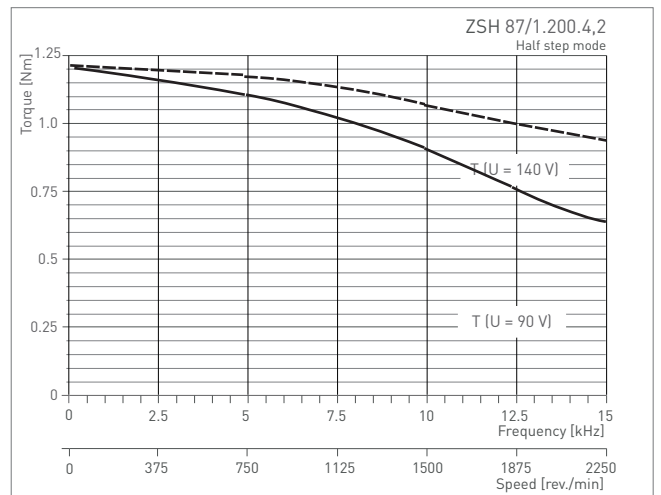
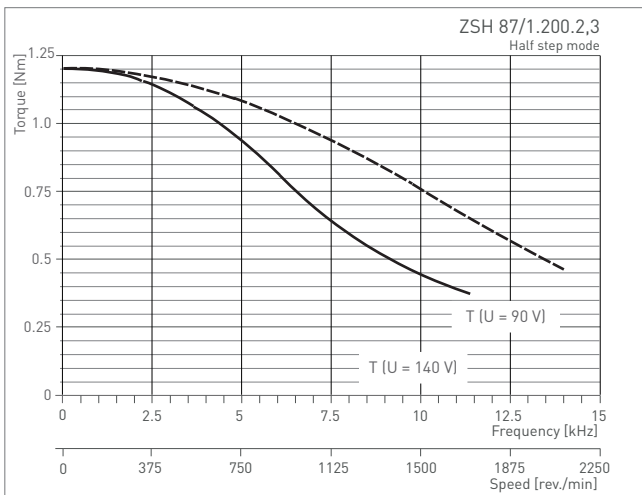
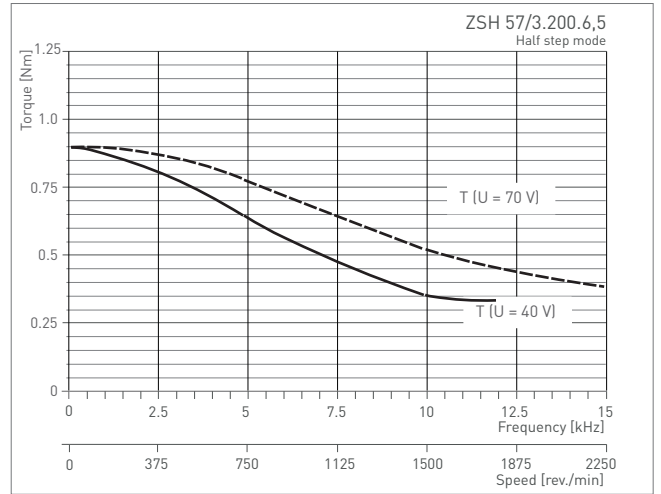
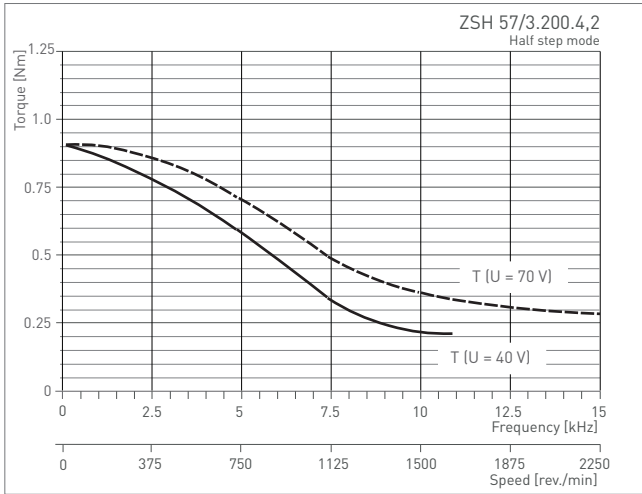

Harsh

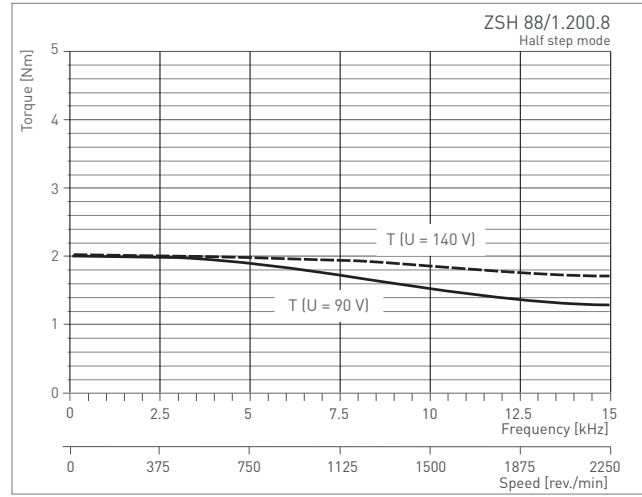
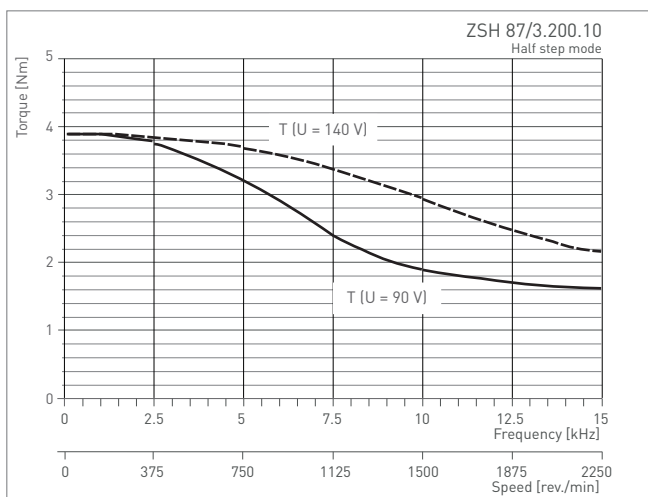
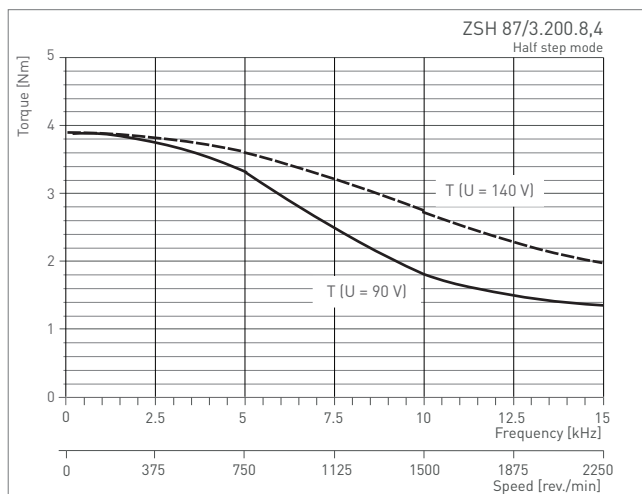
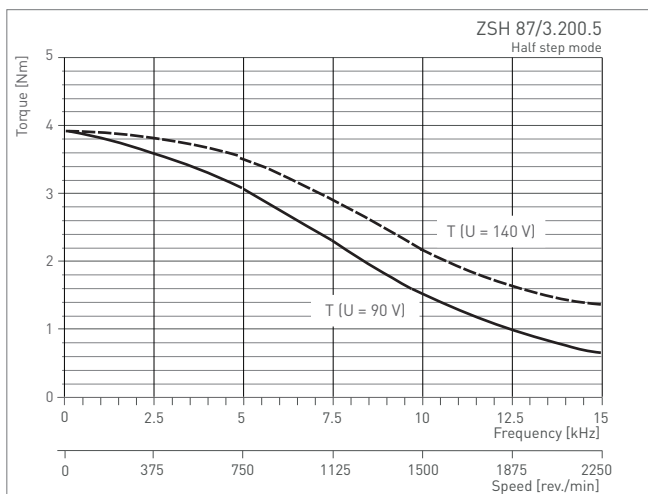
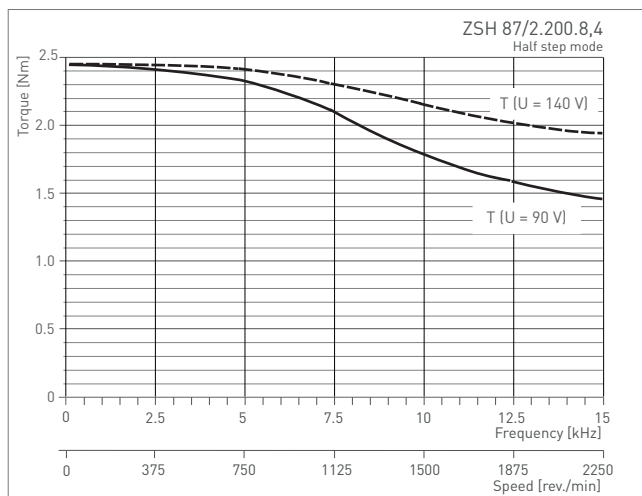
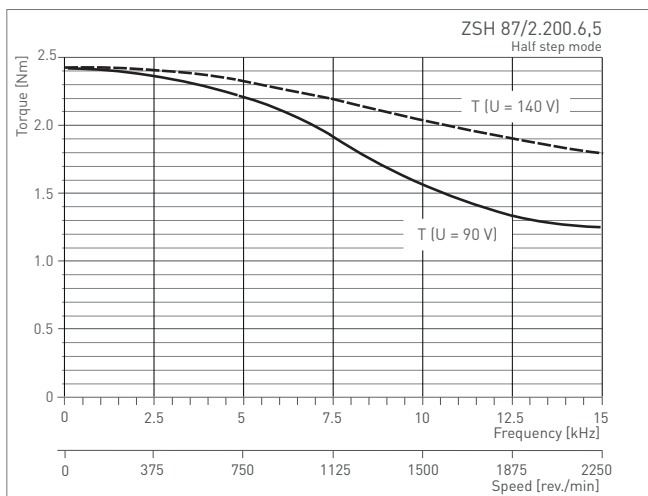

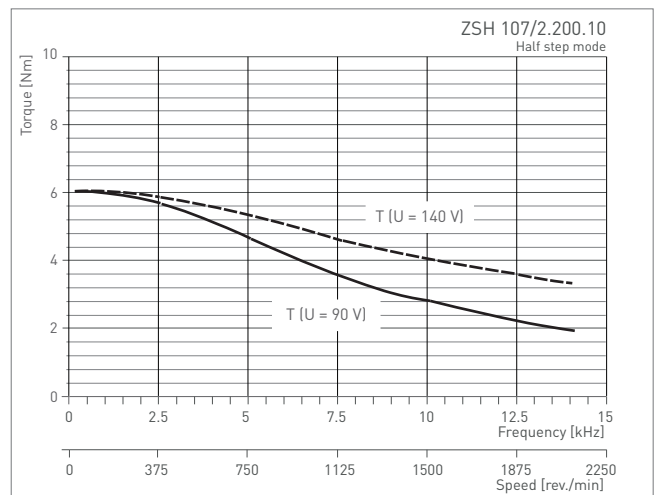
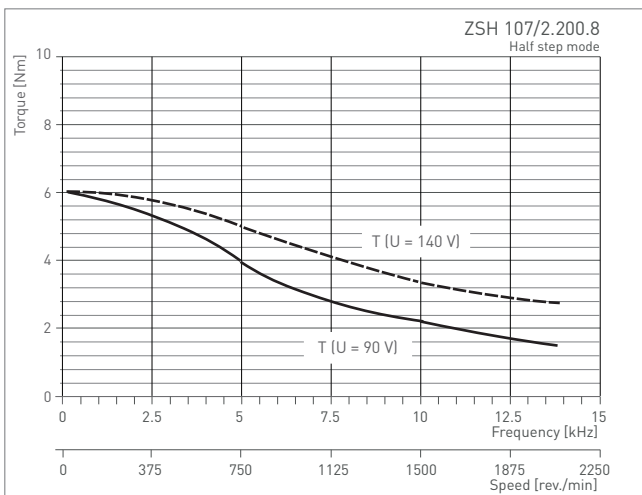
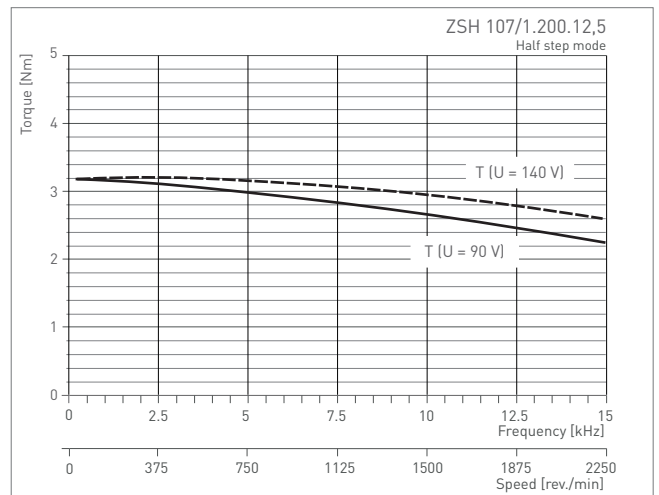
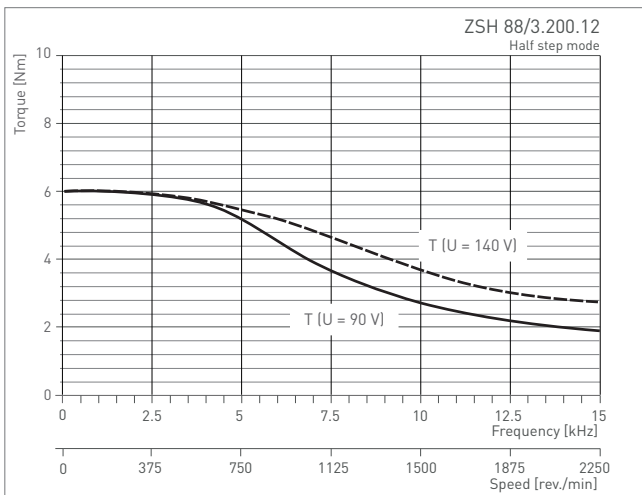
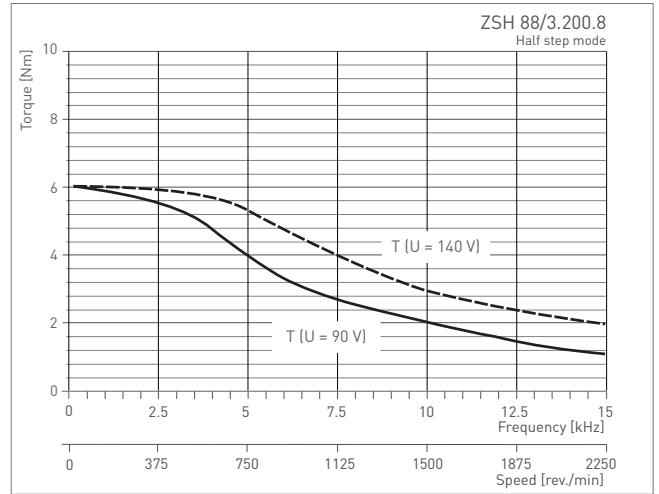
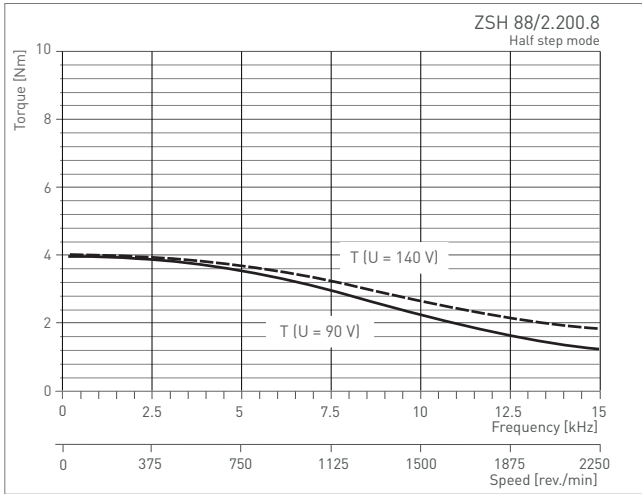

Harsh

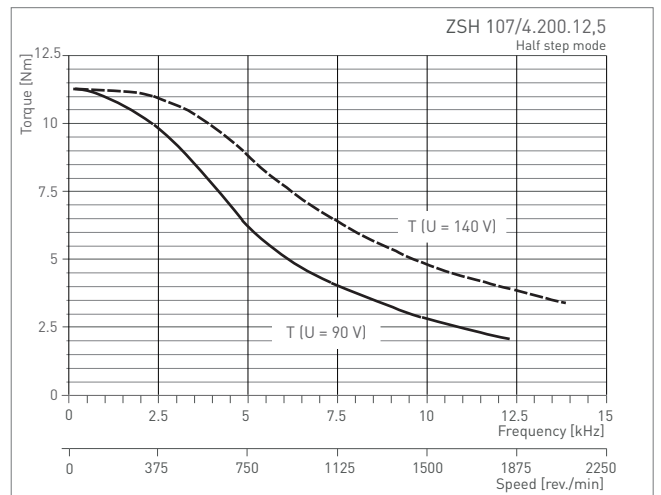
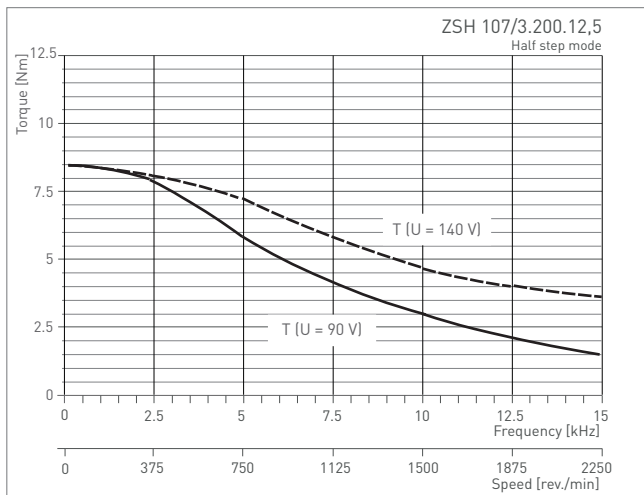
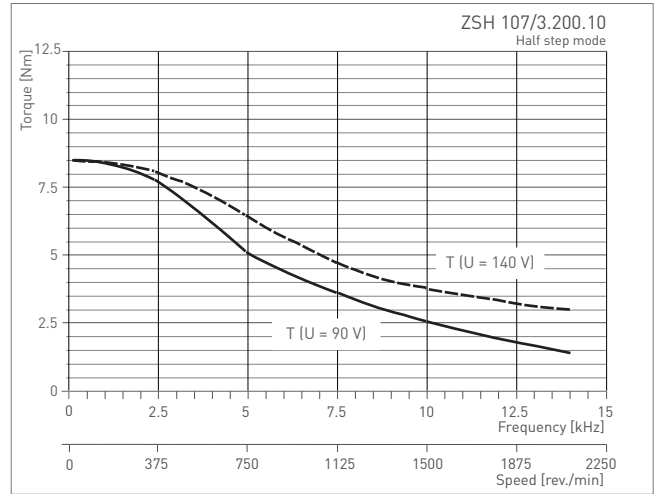
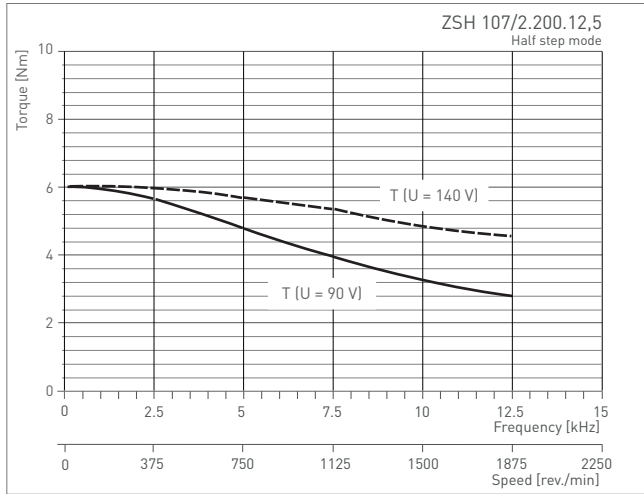

Harsh

Ordering Code

	Type	Edge dimension	Length	Number of steps	Nominal current	Option	Gear	Reduction ratio	Protection class	Connection of the windings
Ordering Code	ZSH	87	3	200	10	H200	PLE	12:1	IP68	4s

Options

Edge dimension	57 / 87 / 88 / 107
Length	1 / 2 / 3 / 4
Nominal current	available windings see page
Option	∅ Shaft/Flange (not specified = standard design)
2nd shaft	E
Free wire ends	FD
Motor brake	B
Encoder	E50 / H200 / H500
Encoder and motor brake	E50-B / H200-B / H500-B
Gear	PLE
Reduction ratio	see page 7
Protection class	not specified = standard protection class IP 54 IP 68
Connection of the windings	not specified = standard wiring scheme: 4-lead/parallel windings
4-lead/serial windings	4s
5-lead	5
8-lead	8

A motor connection leaflet is enclosed to every delivery of stepper motors. PDF files are available for download from the phytron homepage.

All illustrations, descriptions and technical specifications are subject to modifications; no responsibility is accepted for the accuracy of this information.

Phytron GmbH

Industriestraße 12 – 82194 Gröbenzell
 T +49-8142-503-0 F +49-8142-503-190

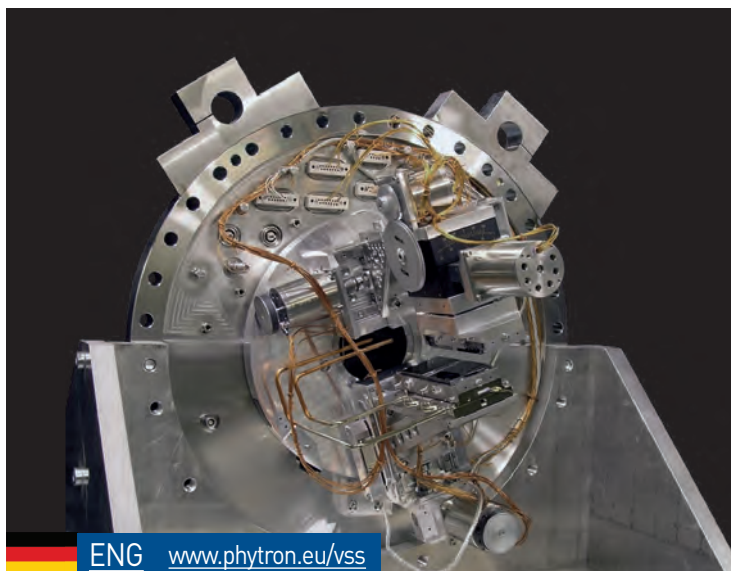

ENG www.phytron.eu/vss



VSS Stepper Motor

For Applications up to Ultra-high-vacuum

RoHS
compliant



Motors for use in vacuum should not only withstand the vacuum (no bursting of air inclusions), they must not contaminate the vacuum either. By selecting suitable materials and optimised conditioning processes phytron VSS stepper motors are ideally suited for use in a vacuum. Through many years of experience with special materials for use in Space, we have put a focus on materials with minimal molecular outgassing and high heat resistance. This is the prerequisite for a high vacuum quality and genuine measurement results in scientific and medical applications.

For exact positioning in vacuum, stepper motors are therefore particularly suitable because they can precisely position even without sensitive feedback providers. Therefore

phytron VSS stepper motors can be used in particularly challenging environmental conditions (radiation, cryo-temperatures and in a modified design even in Space).

Since stepper motors do not generate jitter effects while holding a position, this technology is ideal for precisely aligning optical instruments, mirrors, antennas or samples e.g. in high-resolution microscopes, particle accelerators or molecular analysis devices.

The VSS series is completely manufactured in Germany. You have special requirements? We are pleased to develop a tailored design for your application.

In Focus



High Temperature



Vacuum



Radiation Resistance

- 2-phase stepper motors
- Holding torques from 3.4 mNm to 13 Nm
- Diameters from 19 to 125 mm
- Number of steps 200 (standard)
- Step accuracy 5% for 1.8°
- Operating voltage (power stage)
Size 19 to 57: 70 V_{DC}
Size 80 to 126: 120 V_{DC}
- Protection class IP 20
- Standard connection: 4-lead parallel (option: series or 8-lead)
- Outgassing holes to avoid pockets of trapped gas

Options

- VGPL precision planetary gear or Harmonic Drive gear
- Thermocouple type KTC/ Pt100 resistor sensor
- Resolver
- Double shaft

Customised solutions

- Operating in an aggressive environment
- Clean room applications to clean room class ISO 5 (acc. to ISO 14644-1)
- Motors with spindle

Highlights



Performance & Lifetime

phytron in-Vacuum motors are based on a technology that can also be found in the most challenging projects of our time. From a variety of satellites up to the Mars rover Curiosity: phytron motors drive applications in distant worlds - highly accurate, reliable and durable. Driven within their specification range, high quality components and a proven design make sure: These motors don't let you down!



Cleanliness

phytron motors for use in ultra high vacuum (UHV) contain only materials that also meet the requirements of the ECSS (European Space regulations). Thus, each material has a maximum TML (Total Mass Loss) value < 1% and a maximum CVCM (Volatile Mass Losses) value < 0.1%. You will receive your UHV motor, double-wrapped and vacuum sealed.

Extreme

phytron VSS Stepper Motor

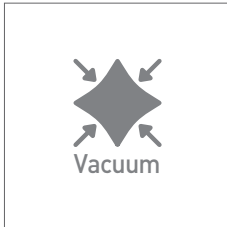
**Conditioning**

The combination of high quality materials and a special conditioning process allow minimal outgassing rates. So a vacuum of 10^{-11} hPa can be achieved depending on the application. For this purpose, individual components of the UHV motors, such as the wound stator, are specially conditioned before installation, so that outgassing materials cannot be deposited in the ball bearings or inside the motor. The fully assembled motor is outgassed by a phytron process at least 200 °C in vacuum chambers. Increased outgassing temperatures are available on request. The rule of thumb: the outgassing rate decreases with a decimal power for every 100 °C increase of the outgassing temperature. In the actual application the motor should always be driven at least 40 °C below the outgassing temperature.

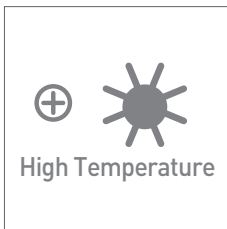
**Temperature Management**

All materials selected for the UHV motors can withstand a short-term winding temperature of up to 300° C. Due to the lack of convection in vacuum, the motors can heat up very quickly and often work at a high temperature level - depending on the duty-cycle. In our UHV motors we integrate a thermocouple to allow monitoring of the exact winding temperature. All vacuum motors can be ordered as an alternative to the thermocouple also with platinum probes (PT) or customer- specific sensors. This is how you protect your motors safe from overheating.

**Adhesives**

The adhesives represent an optimum of strength, ductility, low outgassing rates and thermal resistance. The outgassing rates (TML, CVCM) comply with the European and US-American Space standards. While the first adhesive is not brittle even at 4 K, the second adhesive retains sufficient strength even at a winding temperature of 300 °C for short periods without taking damage.

**Bearings**

The usage of un-lubricated ball bearings can cause so-called cold welding, and thus degrade and completely block the bearing. Therefore, it is advisable to use lubricated ball bearings whenever the application permits. For this purpose a special vacuum grease is necessary to provide not only low outgassing rates but also an extended life-time for the bearing. There is special lubrication for temperatures down to -50 °C or even -70 °C. However, the viscosity is so high that the efficiency decreases considerably. In low temperatures, the use of dry-lubricated bearings is recommended.

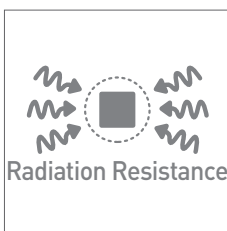
**Radiation resistance**

With ascending vacuum class motors are equally designed for higher radiation dose to be used in the vicinity of radiation sources (e.g. in medicine and research). While a fine vacuum motor can be safely used only up to a dose of 10 J/kg , a UHV motor may be safely operated up to a dose of 10^6 J/kg. A motor not designed for radiation will not only suffer degradation of the insulation and the adhesives - especially the grease of the ball bearing degrades, reduces the efficiency and ultimately blocks the motor.



Structure design

As is commonly done in high vacuum class all structural elements such as housing, flanges and shafts are made of stainless steel. Outgassing holes in the rear flange also allow rapid evacuation and purging of the motors and make sure that no gas inclusions may occur. All structural elements of the magnetic circuit are basically protected against corrosion. This also allows temporarily handling in normal environment.



Handling

phytron VSS motors are primarily designed for use in vacuum. Although the components of the magnetic circuit are basically protected against corrosion, the motors should ideally be handled in clean rooms and clean boxes. A storage is permitted only in phytron's original packaging. The motors are to be handled with suitable gloves. Since the rotor is magnetic, it must necessarily be handled in a clean environment so that no metal particles may be drawn into the motor. That could lead to an impairment of operation, reduce the life time or even cause the failure of the motor by blocking.



Service, Consulting and Customising

Of course we are happy if you are satisfied by our standard! But even if our in-Vacuum motor series contains the application experience of several decades - sometimes the standard is just not enough. We like to fit our motor for your application, because sometimes even small changes make all the difference. Special applications require special support: Our service experts are available even after the purchase.

Vacuum Classes

	Winding temperature [°C]	Vacuum class [ha]	Temperature sensor	Radiation-resistant up to [J/kg]	Conditioning of the components	First outgassing at phytron	TML [%]	CVCM [%]
FV	-20...+150	10 ⁻³	option	10	-	-	-	-
HV	-20...+200	10 ⁻⁷	option	10 ²	-	option	-	-
UHVS solid lubrication	-20...+300 ¹⁾	10 ⁻¹¹	type K ²⁾	10 ⁶	yes	yes	<1	<0.1
UHVG grease lubrication	-20...+300 ¹⁾	10 ⁻¹¹	type K ²⁾	10 ⁶	yes	yes	<1	<0.1
UHVC1 Cryo 1 solid lubrication	-200...+40	10 ⁻¹¹	option	10 ⁶	yes	-	<1	<0.1
UHVC2 Cryo 2 solid lubrication	-270...+40	10 ⁻¹¹	option	10 ⁶	yes	-	<1	<0.1

¹⁾ short-term ²⁾ Pt100 as an option

Extreme

Configuration guide

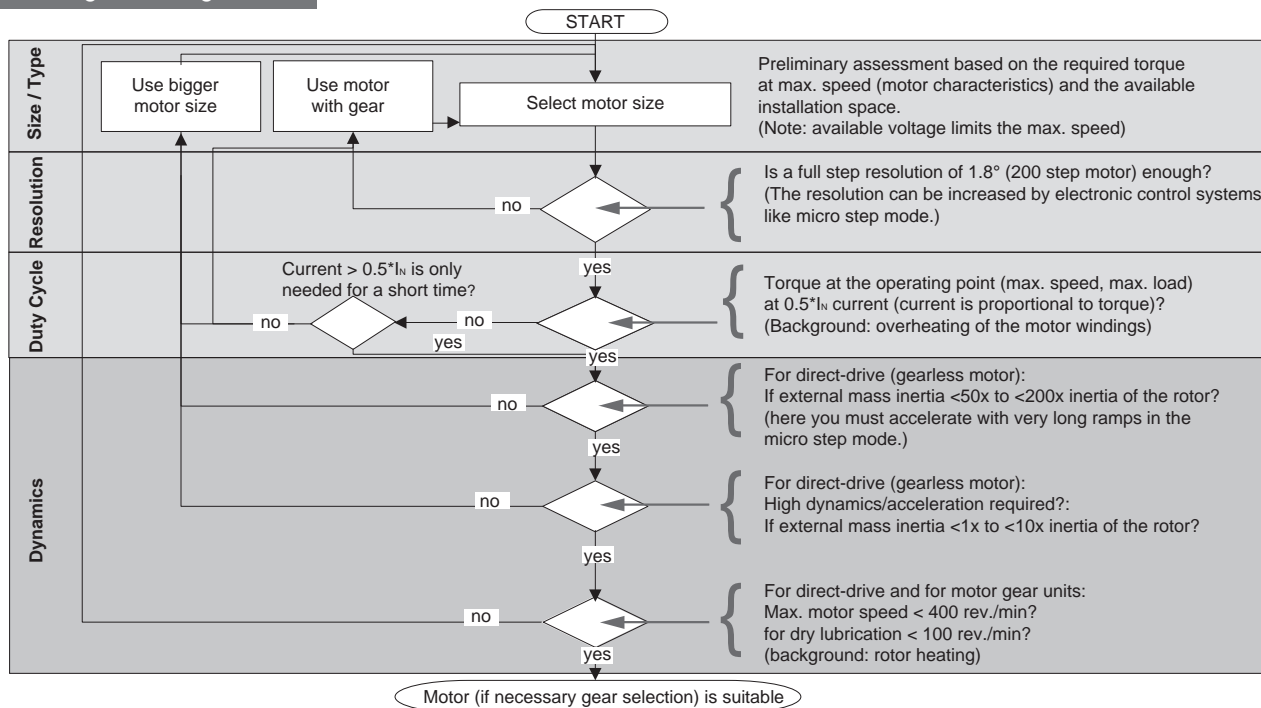

Derating - Duty-Cycle-Design for Applications in Vacuum

Motors driving in a vacuum heat up very quickly depending on their duty cycle. Driven with nominal current the maximum temperature will be reached within several minutes. Therefore it is necessary to monitor the motor's temperature (K-element) or to design a duty cycle with enough off-time to always keep the motor on a safe temperature level.

The shown curve is set at an environmental temperature of 20 °C. To give you an idea of how the chosen current influences the motor temperature we drew two curves of a VSS 57 motor. Driven with 400 rpm at 0.5 of the nominal current, the motor takes longer to heat up due to less ohmic losses then driven with the full nominal current.

The third curve (VSS 32) with 0.5 nominal current and 200 rpm only leads to a steady state temperature within the safe temperature limits. A higher rotational speed increases the magnetic losses. Therefore high speeds should be avoided as far as possible to reduce heat losses and to protect the bearings.

winding temperature (in vacuum), environment 20 °C

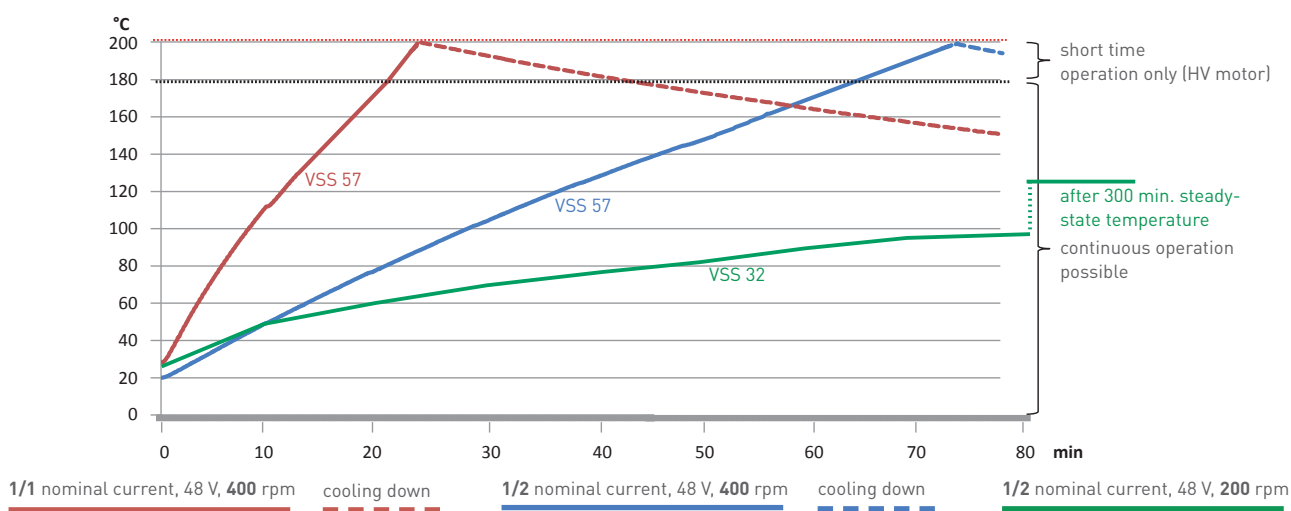

Stepper Motor VSS 19 to VSS 126

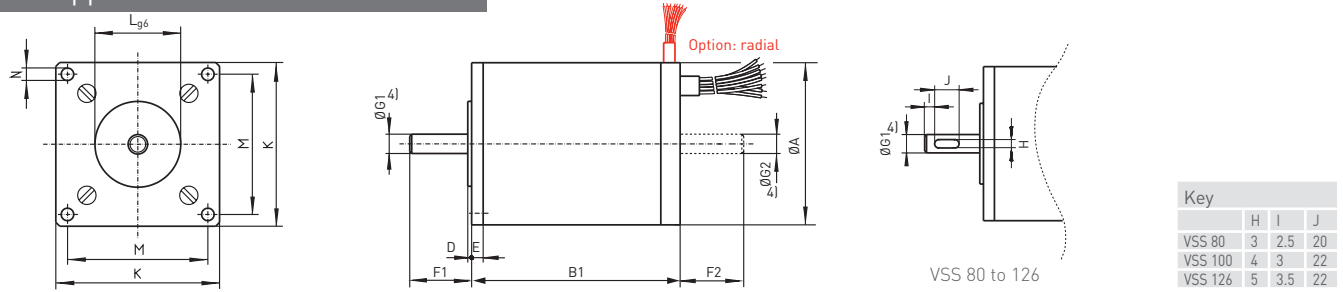

Dimensions / Electrical and Mechanical Characteristics

VSS Standard 200-steps 4 lead parallel ³⁾	Electrical Characteristics				Mechanical Characteristics							Dimensions in mm											
	Current/ Phase IN	Resistance/ Phase	Inductivity/ Phase	max. operating voltage	AWG	Holding torque ²⁾	Detent torque	Rotor inertia	Loads		Mass	A	B1	D	E	F1	F2	G1 ⁴⁾	G2 ⁴⁾	K	L	M	N
									axial	radial													
A	Ω	mH	V _{DC}		mNm	mNm	kg cm ²	N	N	kg													
19.200.0.6¹⁾ 19.200.1.2¹⁾	0.6 1.2	2.1 0.63	0.85 0.23		28	3.4 3.5	0.9	0.0009	3	3	0.05	19	26.5	1	2	7.5	6.5	2.5	2.5	19	10	16	M2.5
20.200.0.6 20.200.1.2	0.6 1.2	3.45 0.95	1.1 0.4		28	8	1	0.002	3	3	0.075	19	43	1	2	7.5	6.5	2.5	2.5	19	10	16	M2.5
25.200.0.6 25.200.1.2¹⁾	0.6 1.2	3.25 0.95	1.5 0.4		28 26	12	2	0.0025	5	5	0.08	25	31	1	2.5	9.5	8.5	3	3	25	14	21.5	2.2
26.200.0.6 26.200.1.2	0.6 1.2	5.85 1.7	3.2 1.0		28 26	28	1.9	0.006	5	5	0.13	25	47	1	2.5	9.5	8.5	3	3	25	14	21.5	2.2
32.200.0.6 32.200.1.2¹⁾	0.6 1.2	4.6 1.25	5.3 1.2		26	40	3	0.01	5	15	0.17	32	38.5	1	3	11	10	4	4	32	18	27	2.8
33.200.0.6 33.200.1.2¹⁾	0.6 1.2	7.5 1.9	9.3 2.2		26	68	3.3	0.018	5	15	0.26	32	57.5	1	3	11	10	4	4	32	18	27	2.8
42.200.1.2¹⁾ 42.200.2.5¹⁾	1.2 2.5	1.7 0.34	3 0.7		24 22	120	5	0.045	20	40	0.35	42	54	1	3	16	15	5	4	42	22	36	3.2
43.200.1.2¹⁾ 43.200.2.5	1.2 2.5	2.6 0.5	5.2 1.2		24 22	235	7	0.077	20	40	0.52	42	69	1	3	16	15	5	4	42	22	36	3.2
52.200.1.2 52.200.2.5	1.2 2.5	2.65 0.6	7 1.6		24 22	350	13	0.15	25	70	0.72	52	65	1.5	3.5	17.5	16	6	4	52	28	44	4.3
56.200.1.2 56.200.2.5	1.2 2.5	3.9 0.8	9.5 2.4		24 22	420	30	0.17	40	80	0.78	56.4	58.1	1.5	4.5	22	20.5	6.35	6.35	60	38.1	47.1	5.2
57.200.1.2 57.200.2.5¹⁾	1.2 2.5	3.9 0.8	11.6 2.9		24 22	840	50	0.24	40	80	0.99	56.4	74.1	1.5	4.5	22	20.5	6.35	6.35	60	38.1	47.1	5.2
80.200.5	5	0.4	2.3		18	2300	120	1.24	50	180	2.8	80	100	2	7.5	27	25	10	9	80	50	68	6.4
100.200.10	10	0.15	2.1		16	4300	140	4.4	70	300	5	100	125.5	2	8	32	30	12	12	100	60	86	6.4
126.200.10	10	0.23	3.9		16	13000	290	18.2	150	700	13.9	125	210	3	9.5	34	31	14	14	125	60	108	8.4

¹⁾ Preferred options: HV and UHVG in small quantities are available from stock

²⁾ Holding torque in bipolar mode with parallel windings, two phases on at rated current

³⁾ other step resolutions on demand (with different mechanical characteristics!)

⁴⁾ Shaft diameter tolerances: VSS 19 to 26: -0.005 to -0.009; from VSS 32: g5

All values given above refer to room temperature and atmospheric pressure.

Extreme

Stepper Motor with VGPL Gear

Shaft		
VGPL	U1	Z1
16	2.8	8
22	3.5	8
26	4.5	12
32	6	0

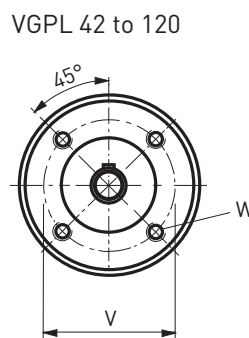
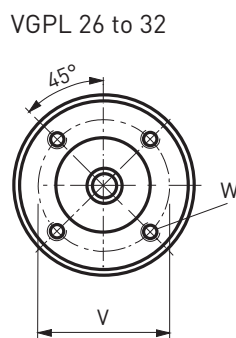
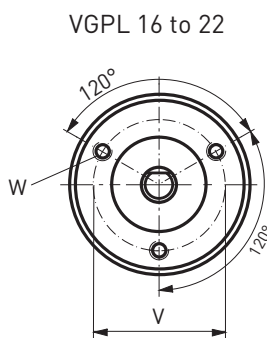
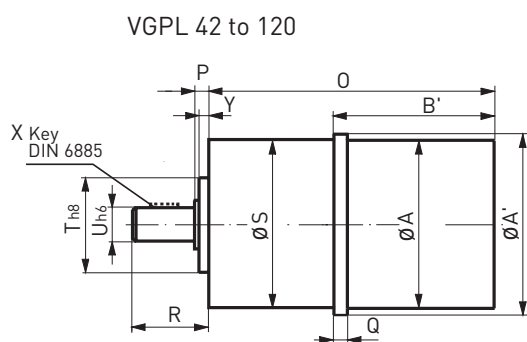
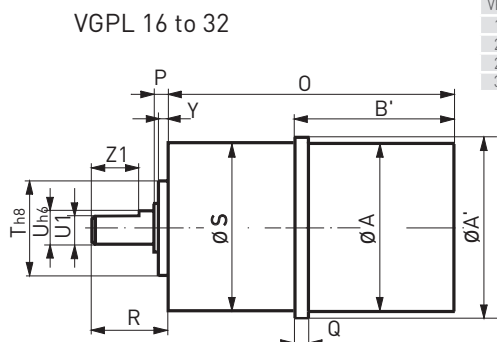

Dimensions

Gear	Stepper motor VSS	Dimensions in mm																	Mass		
		Stages															Stages				
		A	A'	B'	O			P	Q	R	S	T	U	V	W	X	Y	1	2	3	
VGPL 16	19 / 20	19	22	29 / 46	48 / 64.5	53 / 69.5	58 / 74.5	2	4.5	12.5	16	10	3	13	M 2x4	-	1.5	0.07 / 0.09	0.07 / 0.1	0.08 / 0.11	
VGPL 22	19 / 20 / 25 / 26	19 / 25	22 / 25.5	29 / 50 / 34 / 50	50 / 66.5 / 54.5 / 70.5	57 / 73.5 / 61.5 / 77.5	64 / 80.5 / 68.5 / 84.5	2.5	5.5 / 5	15	22	12	4	16	M 2.5x4	-	2	0.5 / 0.12 / 0.13 / 0.18	0.13 / 0.15 / 0.15 / 0.2	0.15 / 0.17 / 0.18 / 0.23	
VGPL 26	25 / 26	25	26	34 / 50	59 / 74.5	67 / 82.5	75 / 90.5	2.5	5	17	26	14	5	20	M 3x4	-	2	0.15 / 0.2	0.17 / 0.22	0.19 / 0.24	
VGPL 32	32 / 33	32	33	41 / 60	69.5 / 88.5	78.5 / 97.5	87.5 / 106.5	4	5	20	32	20	6	26	M 3x5	-	3	0.31 / 0.4	0.35 / 0.44	0.42 / 0.51	
VGPL 42	42 / 43	42	43	58 / 83	93 / 118	105.5 / 130.5	118 / 143	4	7	22.5	42	25	8	32	M 4x8	3x3x14	3	0.63 / 0.8	0.7 / 0.87	0.78 / 0.95	
VGPL 52	52 / 56 / 57	52 / 56 / 57	53 / 57	69 / 62 / 78	109.5 / 103 / 119	124 / 117.5 / 133.5	138.5 / 132 / 148	4	6.7 / 7	24	52	32	12	40	M 5x8	4x4x16	3	1.2 / 1.48 / 1.69	1.3 / 1.6 / 1.81	1.45 / 1.7 / 1.91	
VGPL 80	80	80	80	116	160	178	196	5	23.1	35	80	50	14	65	M 6x12	5x5x20	2.5	3.3	4.9	5.55	
VGPL 105	80 / 100 / 126	80 / 100 / 125	105 / 105 / 125	116 / 146 / 210	183 / 208 / 277	205 / 235 / 299	232 / 262 / 326	6	23.1 / 8 / 9.5	46	105	70	20	85	M 8x20	6x6x28	2.5	6.05 / 8.25 / 17.15	7.55 / 9.75 / 18.65	9.05 / 11.25 / 20.25	
VGPL 120	126	125	125	210	283.5	313.5	343.5	7.5	9.5	57.5	120	80	25	100	M 10x25	8x7x40	3	18.9	21.15	23.4	

Mechanical Characteristics

Gear	Stepper motor	Gear backlash ¹⁾⁵⁾⁶⁾⁷⁾			Rated torque ^{4) 6)8)}			Gear inertia			Radial load ²⁾	Axial load	Efficiency at full load ³⁾			reduction ratio i[:1]				
		arc-min			Nm			kg cm ²					%			i[:1]				
	VSS	Stage			Stage			Stage					Stage			Stage 1	Stage 2	Stage 3		
		1	2	3	1	2	3	1	2	3			1	2	3					
VGPL 16	19 20	20	35	50	0.1	0.3	0.5	-	-	-	30	10				3 / 4	9 / 12 21 / 28 / 16	36 / 48 64 / 84 112 / 147 196		
VGPL 22	19 / 20 25 / 26	10 20	20 35	30 50	0.1	0.5	1.5	0.008	0.006	0.004	30	24				4 / 5	16 / 20 28 / 35	64 / 80 112 / 140 196 / 245		
VGPL 26	25 26				0.3	1	3	0.012	0.010	0.095	50	40						3.5 / 4.33	12.25 / 18.78 26 / 33.22	81.37 / 112.67 143.96 / 199.33
VGPL 32	32 33	8 20	12 35	15 50	0.4 0.8	2 4	6 6	0.015	0.012	0.011	80	65				4 / 4.5 5.2	12.08 / 16 18 / 20.8 25 / 29 32 / 36 41.6	64 / 72 / 81 100 / 130 144 / 200 225 / 256 288		
VGPL 42	42 43				0.7 1.4	4 8	12 12	0.03	0.024	0.024	150	120						3.5 / 4 5	12.25 / 14 16 / 20 24 / 25 30 / 30.67 38.33	49 / 56 64 / 70 / 80 100 / 120 144 / 184 235.11 / 293.89
VGPL 52	52 56 57	6 20	12 35	15 50	1.5 3	10 15	30 30	0.06	0.055	0.05	250	200				4 / 4.5 5.2 / 6.25	12.08 / 16 18 / 20.8 25 / 29 32 / 36 41.6 / 50	64 / 72 / 81 100 / 130 144 / 200 225 / 256 288 / 400		
VGPL 80	80				3 6	15 30	38 38	0.12	0.08	0.075	400	320						3.5 / 4 5	12.25 / 14 16 / 20 / 24 25 / 30 30.67 / 38.33 46	49 / 56 / 64 70 / 80 / 100 120 / 144 / 184 235.11 / 293.89
VGPL 105	80 100				12 25	60 120	150 150	1	0.85	0.8	800	640						3.5 / 4 5	12.25 / 14 16 / 20 24 / 25 30 / 30.67 38.33	49 / 56 64 / 70 / 80 100 / 120 144 / 184 235.11 / 293.89
VGPL 105	126							800	640						3.5 / 4	12.25 / 14 16 / 20 24 / 30.67	49 / 56 64 / 70 / 80 100 / 120 144 / 184 235.11			
VGPL 120	126				25 50	130 250	350 350	1.75	1.4	1.35	1500	1200				3.5 / 4 5	12.25 / 14 16 / 20 24 / 25 30	49 / 56 64 / 70 80 / 100 120 / 144 180		

¹⁾ no load ²⁾ center of the shaft ³⁾ in grease-lubricated operation ⁴⁾ continuous operation
⁵⁾ applies to FV, HV, UHVG for type reduced backlash ⁶⁾ applies to FV, HV, UHVG for type low backlash ⁷⁾ applies to UHVS, UHVC type standard backlash ⁸⁾ type standard backlash

Extreme

Stepper Motor with Resolver

In comparison to other resolvers with variable differential rotary transformer, the resolvers R02010 and R03620 use a constant air gap. They are less sensitive to eccentricity and magnetic stray fields and can directly be connected to standard resolver-to-digital-(R/ D)-converters.

The resolver is suitable for the use in fine, high and ultra high vacuum.

Kapton leads, 500 mm long

Accuracy: ± 60 arcmin (1°)

Sense of Rotation

Positive when CCW seen from leads outlet

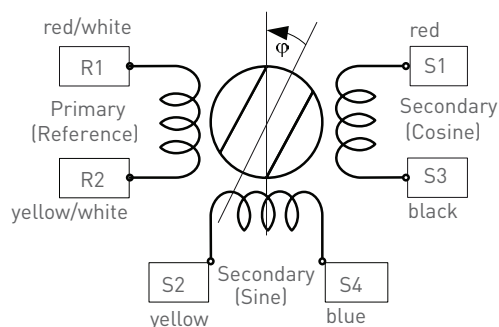

		No
R1	Ref+	1
R2	Ref-	2
S1	Cos+	3
S3	Cos-	4
S2	Sin+	5
S4	Sin-	6

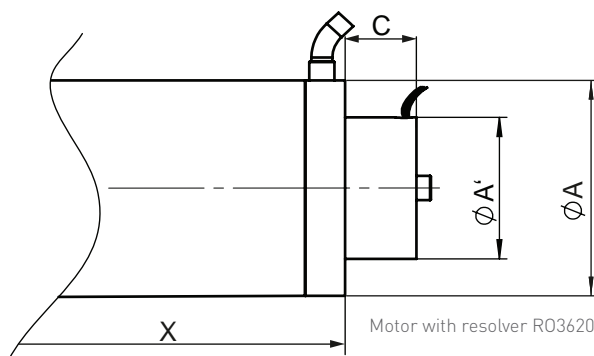

Resolver Specification

Resolver	Stepper motor	A	A'	C	X	Electrical Characteristics			Rotor inertia [gcm ²]	Mass [g] (Resolver)
						Excitation amplitude [V _{r.m.s.}]	Excitation frequency [kHz]	Transformation ratio		
R02010	VSS 25 VSS 26	25	20	15.5	33.5 49.5	2 to 12	5 to 50	0.5 $\pm 10\%$	1	30
R02010	VSS 32 VSS 33	32			41 60					
R03620	VSS 42 VSS 43	42	36.8	17.5	56.5 71.5					
R03620	VSS 52 VSS 56 VSS 57	52			66 59.1 75.1					
		56								
		57								
R03620	VSS 80	80			103.5					
R03620	VSS 100	100			127.5					
R03620	VSS 126	125			216.5					

Resolver - Encoder Converter



Phyton ID: # 10011284

The position data converter controls autonomously the resolver sensor and converts the output signals of the resolver to incremental output signals (square wave signal).

Resolution: 1024 increments

Output reference signal: 8 V_{PP} (diff.)
100 mA max.
10 kHz

Input SIN/COS: 4 V_{PP} (max.)

Resolver transformation factor: K= 0.5

Supply voltage: 24 V (14...36 V_{DC})

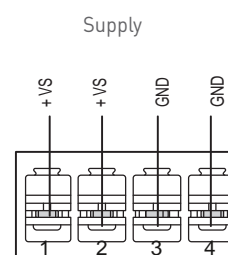
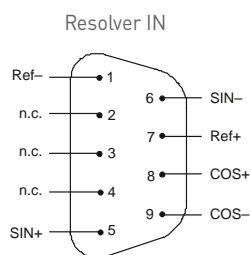
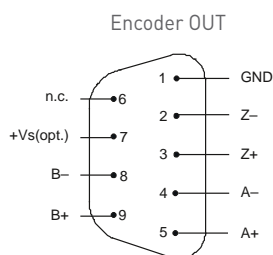

phytron's modular *phyMOTION*[™] controller evaluates the resolver signals directly with the newly developed resolver evaluation module ECMS01.

Thermocouple Type K and Resistance Temperature Detektor Pt100

The insulated temperature sensor in phytron motors is integrated in the motor windings. The response time to temperature changes of the winding is very short, compared to temperature sensors mounted outside the motor housing. The temperature is measured all the time (even only one motor phase is powered at any time), because the sensors are always mounted between the phases.

Thermocouple element type K

phytron uses with the Type K (NiCr-Ni) in-vacuum and cryo stepper motors, thermal elements in the temperature range from -270 to +1370 °C, accuracy class 1. The Type K is a metal thermal element with nickel-based alloy conductors. Temperature ranges, accuracy and characteristics of thermal elements for industrial use are defined in the IEC 584 standard (temperature measuring with thermal elements)

The accuracy of the temperature measuring depends on the temperature of the reference point.

Resistance temperature detector (RTD) Pt100

phytron uses Pt100 resistor sensors in in-vacuum and cryo stepper motors in the temperature range -200 to +300 °C. These precise sensors are used in extreme industrial and laboratory conditions. They consist of a wound resistance wire that is mounted and unsupported inside a cylindrical ceramic case

The evaluation of the temperature measuring is possible with the corresponding module in the *phyMOTION*[™] controller. For the K type variations to some degree are possible.

Phyton devices and controllers for the evaluation of Pt100 resistor sensors and thermal element type K

1-axis controller MCC-1
2-axes controller MCC-2
Multi-axes controller *phyMOTION*[™]

Extreme

Option: Shaft design with flat surface

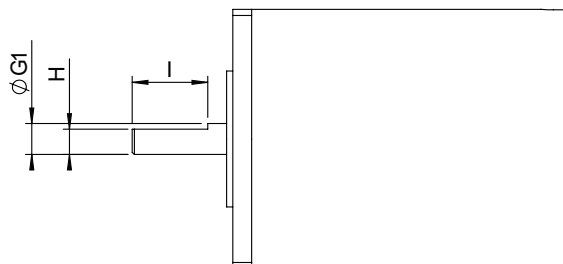
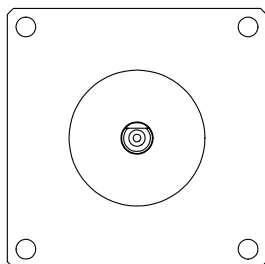

Dimensions

Stepper motor	Dimensions in mm		
Typ	G1	H	l
VSS19	2,5	2	4,5
VSS25 VSS26	3	2,5	6,5
VSS32 VSS33	4	3,5	8
VSS 42 VSS 43	5	4	13
VSS 52	6	5	14
VSS 56 VSS 57	6,35	5,5	18,5

More shaft options on demand.

Torque Characteristics

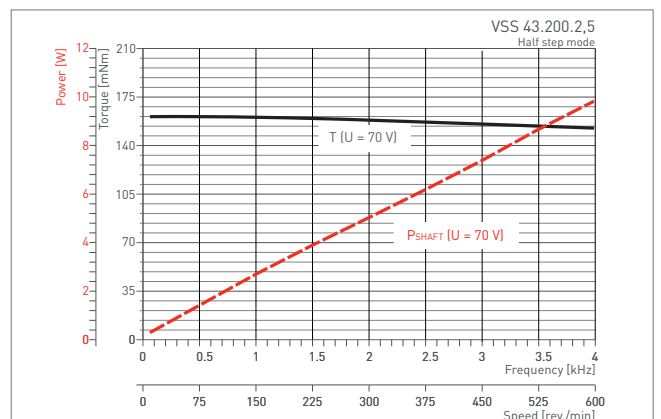
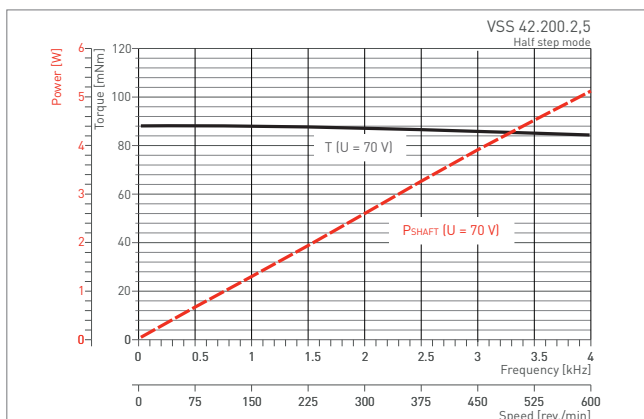
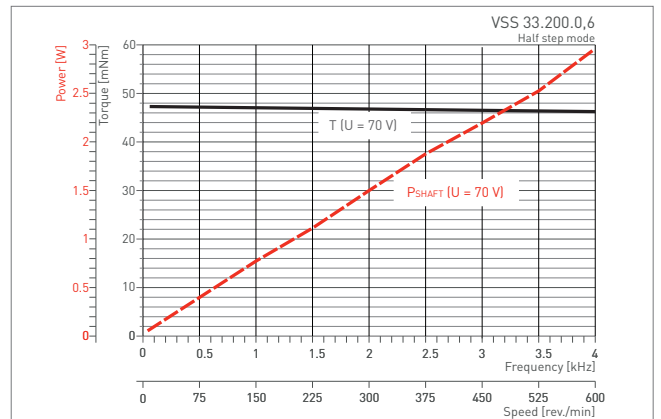
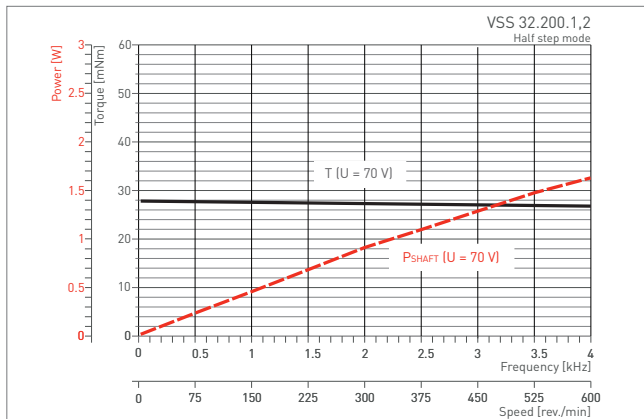
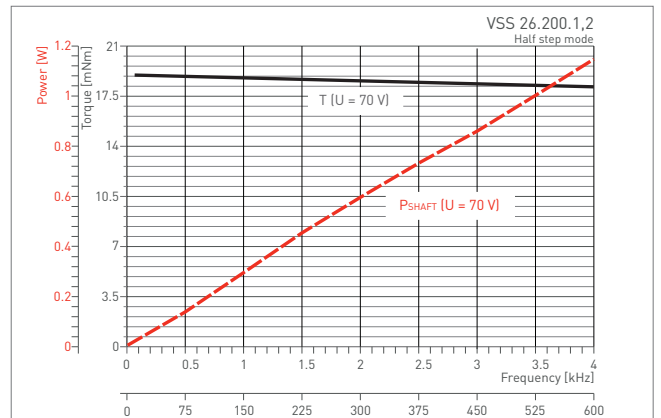
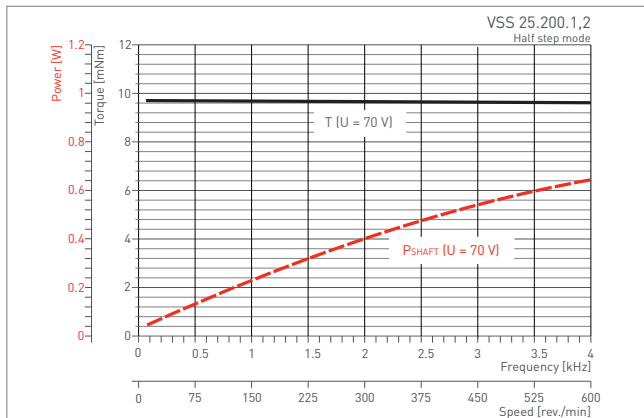
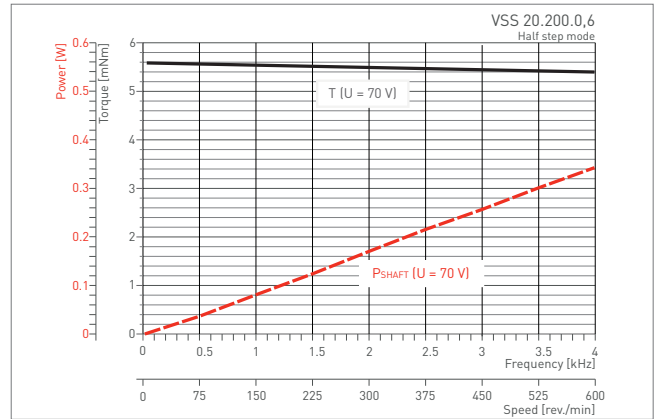
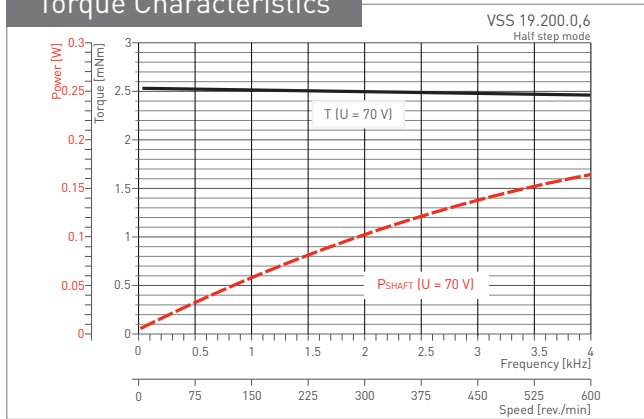

Extreme

Torque Characteristics

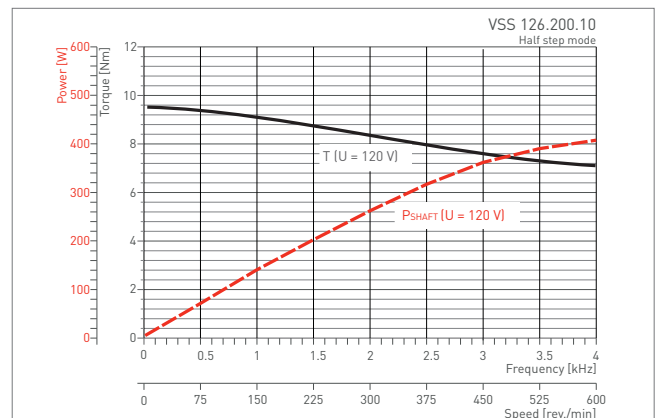
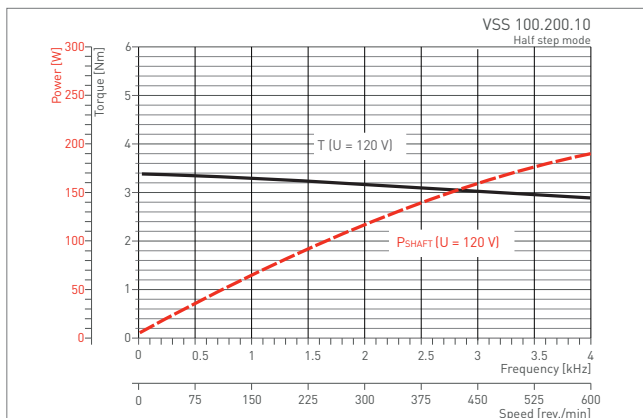
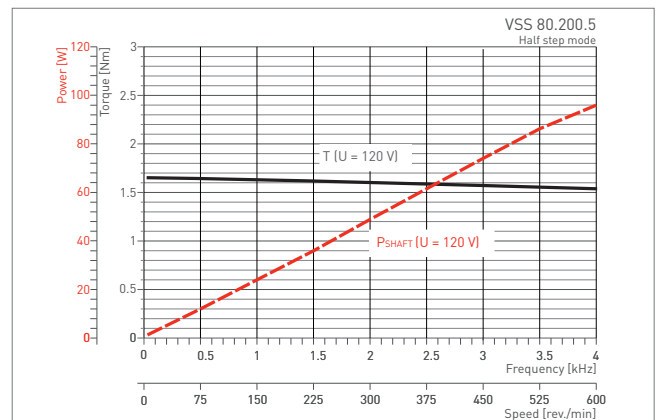
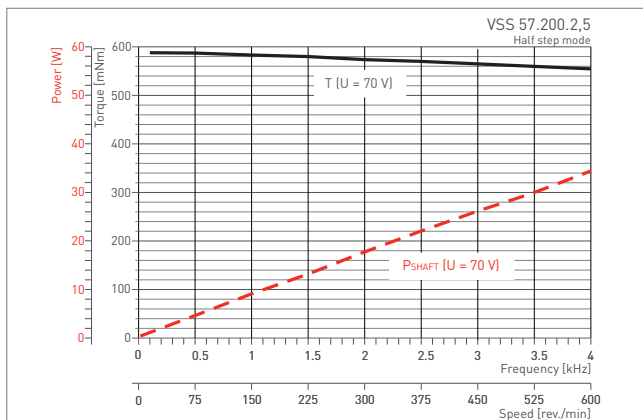
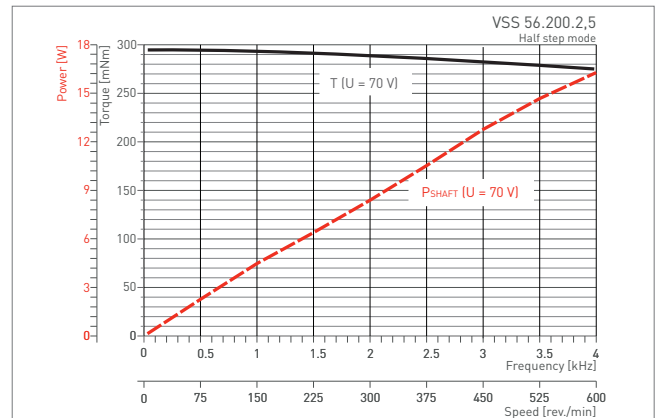
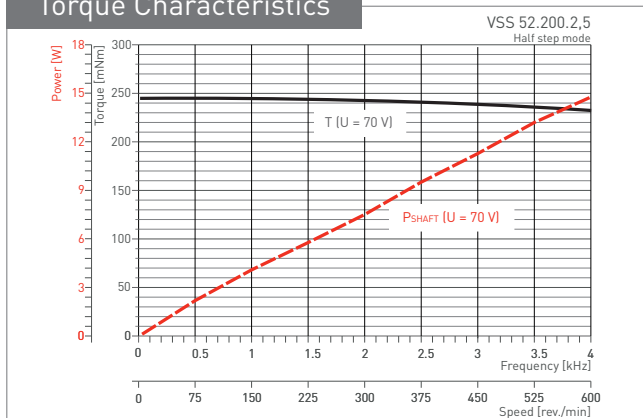

U = 70 V_{DC} / 120 V_{DC}: Operating voltage of the power stage (intermediate circuit voltage)

Efficient Customising - the perfect fit

Combine efficiently standard components, modifications & specials

For 30 years we have used our know-how in a lot of successful space projects to optimise our vacuum series for industrial and scientific applications in the matter of performance and cost efficiency. The specific designs of the two-phase hybrid stepper motors have been designed for use in vacuum up to 10^{-11} hPa. Phytron vacuum stepper motors are conditioned at up to 250 °C for use in the **high-(HV) or ultra-high vacuum (UHV)** and are designed dependent on the applications for the **low-temperature range up to -196 °C (N₂), -269 °C (He), or high-temperature range (winding temperature up to +300 °C)** and, if necessary, also for **radiation up to 10^6 J/kg**.

Starting from the VSS series we have already implemented a number of customer specific projects. Performance, housings, flanges, materials, shaft machining – in the common specification process, the VSS platform can be optimised for your project. With our high in-house production depth we are not only technologically very flexible, we can also produce small quantities.

Applications

Our vacuum motors, power stages or controllers are driving in a lot of different applications:

- Particle accelerators and X-ray measuring systems (PETRA III, PANTER, FERMI, PAL, SOLEIL,...)
- Devices for molecular analysis
- Electron microscope
- Sputtering systems
- Cryostats

Stepper motor spindle version for a particle accelerator

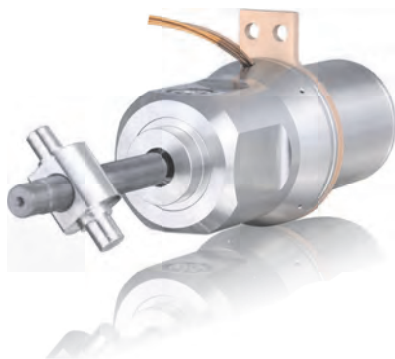

Adjustment of particle accelerator cavities

- stepper motor with 200 steps/revolution (1.8°), with integrated gear 50:1 (10:000 steps/revolution)
- designed for 1300 N axial force
- spindle and nut system, non-magnetic
- material for housing, flanges and internal parts stainless steel or titanium
- dry lubricated for usage under vacuum at -270 °C up to +40 °C (also as grease lubricated version for environments > 35 °C)
- optional EMC cable shielding
- thermocouple K-type in winding

Extreme

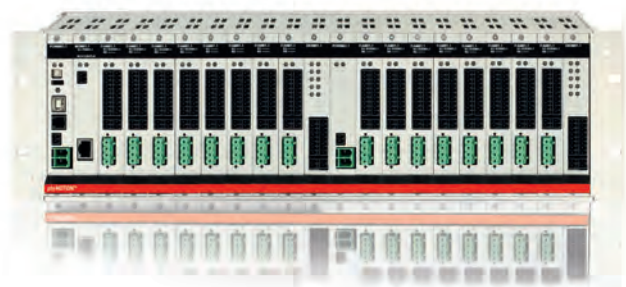
Motion controller for vacuum application: *phyMOTION*TM

Modular stepper motor controller for in-vacuum applications

The *phyMOTION*TM controller is ideally equipped for the demands of in-vacuum projects. Beside the encoder evaluation (differential incremental encoder with quadrature signals, absolute encoder acc. to SSI standard, EnDat-encoder) a resolver and temperature sensor evaluation of each axis is possible for monitoring of the driven motors. This functions can be integrated as optional sub-modules of each axis – in addition to the default limit switch evaluations of each axis. So, you pay only what you really need. The better part of cabling effort is eliminated because the power stages are already integrated.

You can combine with 6 to 21 modules of each housing up to 18 power stages with different functions (axis modules, digital I/O, analogue I/O, 4-axis indexer for interpolation, integrated display)

Via freely selectable HOST interface (Profibus, Profinet, Ethernet, RS232, RS484, USB, Bluetooth) and provided drivers and protocols (LabVIEW VI, EPICS) you can seamlessly integrate the *phyMOTION*TM also below existing systems.

Operate the *phyMOTION*TM as free programmable stand-alone controller, as distributed intelligence, or also as a slave system i.e. below existing PLC systems.



Encoder types suitable for the **encoder evaluation**:

- Differential incremental encoder with Quadratic signals
- Absolute encoder acc. to SSI standard
- EnDat encoder
- Resolver

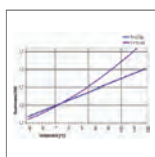

Temperature evaluation module for **stepper motor temperature monitoring**

Thermal elements type K or Pt100 resistor sensors can be used. The insulated temperature sensor in phytron motors is integrated in the motor windings. The response time is very short. The temperature is measured all the time, even if only one motor phase is powered at any one time.

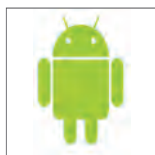

Control via Android-based integrated touch panel (TPM01) or via Android-based tablets (from version V4.0)

- As user interface i.e. for parameter selection
- For support, parameterisation and diagnostics



LabVIEW®-VI

VIs for *phyMOTION*[®] – simulation software with graphical style

Use the VIs (Virtual instruments) generated by Phytron and integrate them in your LabVIEW[®] project. So you can easily control the phytron controller *phyMOTION*TM from your usual programming environment.

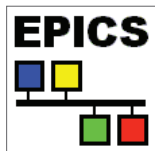

Software environment to develop and realise distributed control systems for large-scale experiments such as telescopes and accelerators. EPICS provides the SCADA support.

Phytron delivers the source code to integrate the phytron controller *phyMOTION*TM into EPICS environment. Also in multi-axis operation: positioning, limit-switches, encoder evaluation

Extreme

Electrical Connection

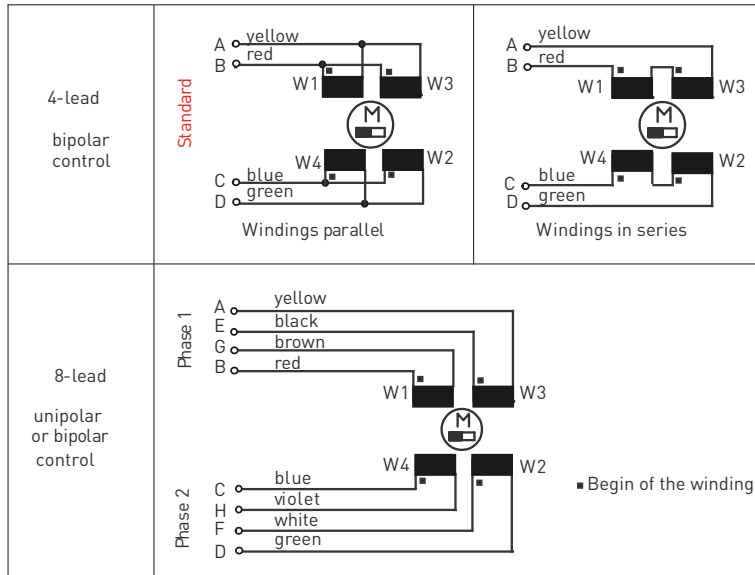

All illustrations, descriptions and technical specifications are subject to modifications; no responsibility is accepted for the accuracy of this information.

Ordering Code

The variable elements of the product are displayed in colour.

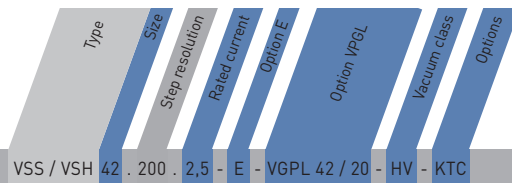

Ordering code: VSS / VSH 42 . 200 . 2,5 - E - VGPL 42 / 20 - HV - KTC

Options		
Size	19 - 125	
Rated current [A/Phase]	0,6 1,2 2,5 5 10	for VSS 19 to 33 for VSS 19 to 57 for VSS 42 bis 57 for VSS 80 for VSS 100 bis 126
Option E	E	Double shaft no double shaft
Option VGPL	VGPL xx/xx	Low backlash gear: size / reduction ratio no gear
Vacuum class	FV HV UHVS UHVG UHVC1 UHVC2	Fine vacuum High vacuum Ultra high vacuum dry coated bearing Ultra high vacuum greased bearing Ultra high vacuum Cryo temperature down to liquid Nitrogen Ultra high vacuum Cryo temperature down to liquid Helium
Options	R KTC Pt RS X	Radial wire outlet Thermocouple type K*) Resistance temperature detector Resolver customised no

*) Standard for vacuum class UHVS and UHVG.

Phase currents

Admissible phase currents for identical power dissipation

Bipolar control mode
Full step operation

4-lead motor	4-lead motor
parallel windings	series windings
rated current	50% of the rated current

Phytron GmbH

Industriestraße 12 – 82194 Gröbenzell
T +49-8142-503-0 F +49-8142-503-190

 ENG www.phytron.eu/phySPACE

phySPACE™

Stepper Motor Series for SPACE applications, Standard and Customised solutions

With 25 years of space heritage and over 300 motors in space we know how to optimise weight, power consumption, thermal dissipation and stray magnetic flux without sacrificing precision or reliability.

phySPACE™ represents a standard stepper motor series for SPACE applications. This series comes with features essential to usage in extreme environments. Beyond that it is also the basis for customised projects - to optimise motor-load coupling.

Our phySPACE™ stepper motors are cost-efficient, clean and reliable even within extreme environments. The phySPACE™ series is developed and built to resist vacuum, vibrations, low/high temperature and radiation while maintaining high performance, precise positioning, long life.

Highlights



Performance & Lifetime

phytron phySPACE™ motors are based on a technology that can also be found in the most challenging projects of our time. From a variety of satellites up to the Mars rover Curiosity: phytron motors drive applications in distant worlds - highly accurate, reliable and durable. Driven within their specification range, high-quality components and a proven design make sure: These motors won't let you down!



Cleanliness

phytron motors for use in space contain only materials that also meet the requirements of the ECCS (European Cooperation for Space Standardisation). Thus, each material has a maximum TML (Total Mass Loss) value of 1% and a maximum CVCM (Collected Volatile Condensable Materials) value of 0.1%. You will receive your space motor, double-wrapped and vacuum-sealed.

In Focus



Vacuum



Radiation Resistance

Standard

- 2-phase stepper motors
- holding torques from 3.1 to 420 mNm without gearing
- diameters from 20 to 57 mm
- 200 steps (1.8° per full step)
- designed for high shock and vibration loads
- 4 leads parallel
- preconditioned, protection IP 20
- embedded K-type thermocouple
- Ambient temp. -40 °C... +120 °C
- up to +200 °C (winding)
- radiation up to 10⁶ J/kg
- bake-out temperature up to 200 °C (24 h)
- outgassing TML <1 %, CVCM <0.1% (at <125 °C)

Options

- "light weight" upgrade (Titan)
- "space-testing" upgrade (vibration, shock, thermal cycling)
- Winding cold redundant
- for Cryo applications up to -269 °C

Customised Solutions

- special designs based on the phySPACE series
- Gears

Space

phySPACE stepper motor



Structure design

The structure design of the phySPACE™ motors presents an optimum of lightweight, stiffness and surface protection. As is commonly done in high-vacuum class all structural elements such as housing, flanges and shafts are made of stainless steel. Even the standard version in stainless steel is optimised in terms of weight: The quadratic flange is reduced to flange lugs and the flanges are hollowed to save additional weight. In order to save even more weight the phySPACE™ comes with the option for a „light-weight“-material like titanium.



Bearings

The shock and vibration loads of a rocket launch can stress or damage the ball bearings significantly - resulting in reduced life under certain circumstances - when the motor hasn't even been put into operation. The phySPACE™ standard motor is equipped with special ABEC 7 bearings. A duplex bearing assembly in the front flange dissipates the vibration loads safely into the housing structure. Especially when in a vacuum, unlubricated ball bearings can be affected by „cold welding“, and thus degrading and even binding the bearings.



Adhesives

The adhesives used are qualified for space applications according to ECSS Q-70-02A. They represent an optimum of strength, ductility, low outgassing rates and thermal resistance. The outgassing rates (TML, CVCM) comply with the European Space Standards and American space standard.

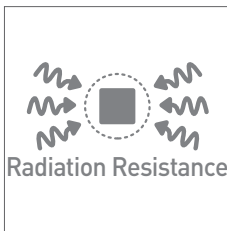

Radiation Resistance

The phySPACE™ motors are designed for radiation of up to 10^6 J/kg for use in space applications. A motor not designed for radiation will not only suffer degradation of the insulation and the adhesives - especially the grease of the ball bearing reducing the efficiency and will eventually cause the motor to fail.

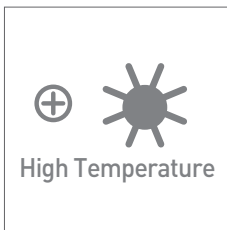

Temperature Management

All materials selected for the phySPACE™ motors can withstand a short-term winding temperature of up to 200° C. Due to the lack of convection in a vacuum, the motors can heat up very quickly and often work at a high temperature level - depending on the duty-cycle. In our phySPACE™ motors we integrate a thermocouple to allow monitoring of the exact winding temperature. This is how you protect your motors from overheating.

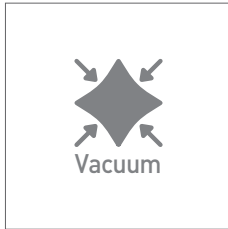

Preconditioning

The selected materials and components are outgassed by a phytron process at up to 200 °C in vacuum chambers, so that outgassing materials cannot deposit in the ball bearings or inside the motor. This way we provide a minimum molecular contamination of the surrounding system so that the motors can even operate close to optical systems.



Handling and Storage

phySPACE™ motors are primarily designed for use in a vacuum. For this reason the motors must always be handled under controlled conditions: On the ground at 20 °C +/-10 °C and relative humidity <=50%, in clean rooms and clean boxes. Long-term storage is permitted only in unopened original phytron packaging. After storage, or not rotating for more than 6 months, a „running-in“ is highly recommended in order to distribute the grease evenly again. The motors are to be handled with suitable gloves. Since the rotor is magnetic, it must be handled in a clean environment so that no metal particles can be pulled through the opening at the rear of the motor into the motor. Particles in the motor lead to an impairment of operation, the lifetime, or even failure of the motor due to binding.



Service, Consulting and Customising

Of course we are happy if our standard already fulfills your application's needs! Although our phySPACE™ series integrates our application experience of the last decades - sometimes the standard is just not enough. We offer to create customised solutions to make our motor a perfect fit for your application, because sometimes even small changes make the difference.





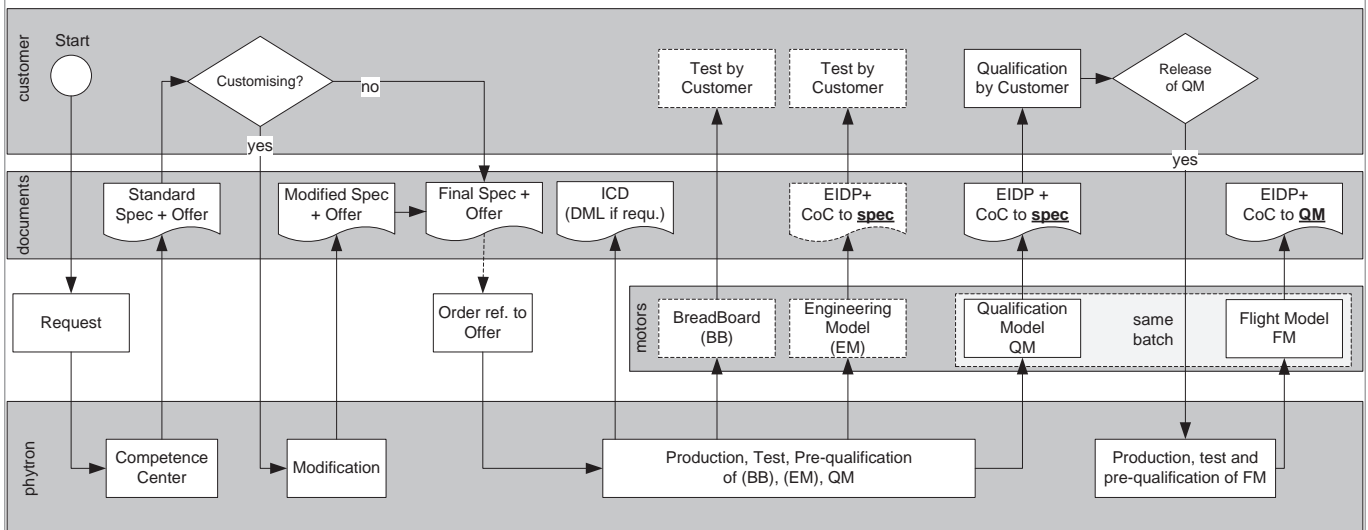

Road-Map & Milestones

phytron project partnership: receive the perfect space motor for your application.



Space

Technical Characteristics

		Standard	 Upgrade Options
General Characteristics	Number of steps / step angle	200 / 1.8 °	
	Physical step accuracy (non accumulating)	3 to 5 %	
	Speed (typical for continuous operation)	400 rpm	
	Preferred direction	clockwise (facing the motor shaft)	
	Bearing quality / arrangement	ABEC7 / Duplex (front)+ floating bearing (rear)	
	Lubrication	space grade compatible	 non / dry
	Housing	stainless steel	 „light weight“ titan
	Protection class	IP 20	
	Expected lifetime (typical)	20 x 10 ⁶ revolutions	
Electrical	Operating voltage	up to 48 V	
	Control	bipolar	
	Leads: amount / wiring / wire exit	4-leads bipolar / parallel / axial	 cold redundant
	Lead insulation	Kapton	
	Temperature sensor	type K	
	Dielectric strength	>500 V _{AC} with 50 Hz	
	Insulation resistance (depending on diameter)	>100 MΩ with up to 500 V _{DC}	
Cleanliness	Pre-Conditioning	first outgassing by phytron	
	CVCM (Collected volatile condensable materials) at 125°	< 0,1 %	
	TML (Total Mass Loss) at 125°	<1 %	
	Magnetic emission	upon request	
Environmental	Surrounding Environment	vacuum (UHV)	
		atmosphere (with restrictions)	
	Radiation resistant up to a dose of	10 ⁶ J/kg	
	Environment temperature (operating)	-40...+120 °C	 higher temperature upgrade/ Cryo temperature upgrade
	Environment temperature (non operating)	-70...+140 °C	
	Temperature max. (winding)	max. +200 °C	
	Environment (storage)	+10...+50 °C; original packing	
	Humidity (max.)	<=50 %	
	Vibration GRMS	20	
Test	Test: electric / mechanic / dynamic / climate	standard	
	Test: Vibration / Shock / Thermal Vacuum Cycling	-	 „space-testing“
	EIDP (End Item Data Package)	standard	

Stepper motor space™ 19-2 to 56-2

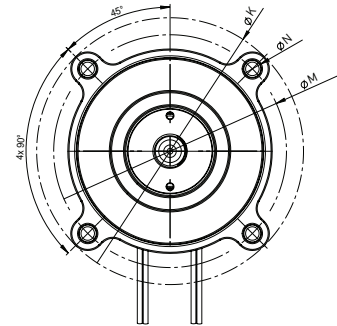
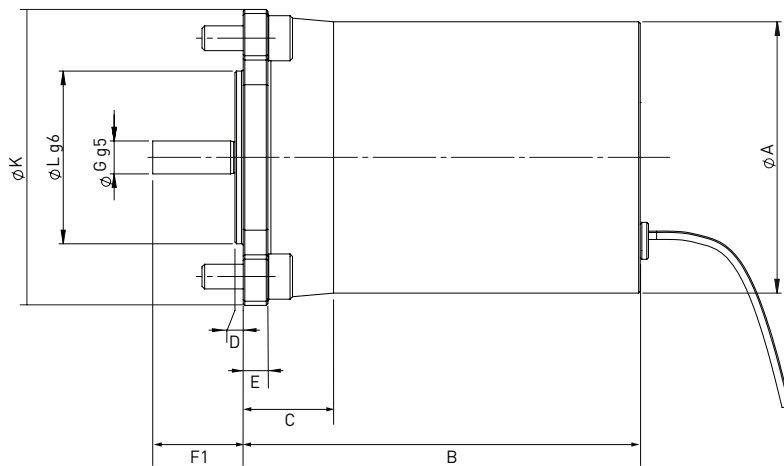

phySPACE™ 19-2 to 42-2

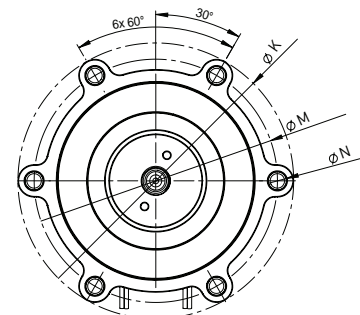

phySPACE™ 52-2 and 56-2

Dimensions / Electrical and Mechanical Characteristics

phySPACE™ Standard 200-step 4 lead parallel bipolar	Electrical Characteristics				Mechanical Characteristics						Dimensions in mm										
	Current/ Phase In	Resistance/ Phase ⁴⁾	Max. operating voltage ⁵⁾	AWG	Holding torque ¹⁾	Power-OFF torque	Rotor inertia	Loads ²⁾		Mass ³⁾	A	B	C	D	E	F1	G ⁹⁵	K	L ⁹⁶	M	N
								axial	radial												
A	Ω	V _{DC}		mNm	mNm	kg cm ²	N	N	g												
19-2	0.6 1.2	2.1 0.63	48	28	3.8	0.9	0.0009	10	15	70	20	34	10.5	1.5	2	7.5	2.5	32	10	27	2.2
25-2	0.6 1.2	3.25 0.95		28 26	13	2	0.0025	15	25	100	26	36	10.5	2.5	2.5	9.5	3	38	14	33	2.7
32-2	0.6 1.2	4.6 1.25		26	50	3	0.01	30	45	211	33	48	11	2.5	3	11	4	47	18	42	3.2
42-2	1.2 2.5	1.7 0.34		24 22	140	5	0.045	30	50	425	43	60	16	2.5	3.5	16	5	62	22	54	4.2
52-2	1.2 2.5	2.6 0.6		24 22	450	12	0.15	65	100	900	53	75.5	17	1	5	21	6	75	38	66	5.2
56-2	1.2 2.5	3.9 0.8		24 22	500	50	0.24	50	80	970	57	70	16.5	2.5	4.5	22	6	77	38	68	5.2

¹⁾ Holding torque in bipolar mode with parallel windings. Two phases on at rated current

²⁾ Axial radial loads are for mounting purposes only. A flexible coupling must be used in operation.

³⁾ The use of titanium parts reduces the overall weight by 20 %.

⁴⁾ differently with redundant winding

⁵⁾ max. operating voltage of the power stage (intermediate circuit voltage)

All values given above refer to room temperature and atmospheric pressure. Other sizes available upon request

Space

Option: Shaft Design

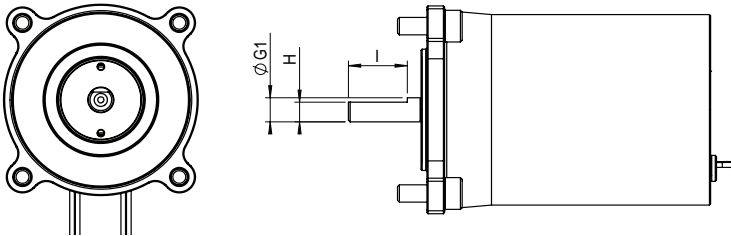

More shaft options upon request.

Dimensions

Stepper motor	Dimensions in mm		
	G1	H	I
phySPACE 19	2.5	2	4.5
phySPACE 25	3	2.5	6.5
phySPACE 32	4	3.5	8
phySPACE 42	5	4	13
phySPACE 56	6	5	18.5

Derating - Duty-Cycle-Design for Applications in Vacuum

Motors operating in a vacuum heat up very quickly depending on their duty cycle. Driven with nominal current the maximum temperature will be reached within several minutes. Therefore it is necessary to monitor the motor's temperature (K-element) or to design a duty cycle with enough off-time to always keep the motor a safe temperature level.

The shown curve is set at an environmental temperature of 20 °C. To give you an idea of how the chosen current influences the motor temperature we drew two curves of a motor similar to the phySPACE™ 56. Driven with 400 rpm at 50 % of the nominal current, the motor takes longer to heat up due to less ohmic losses than driven with the full nominal current.

The third curve (phySPACE™ 32-2) with 0.5 nominal current and 200 rpm only leads to a steady state temperature within the safe temperature limits.

A higher rotational speed increases the magnetic losses. Therefore high speeds should be avoided as far as possible to reduce heat losses and to protect the bearings.

The cooling down speed during the off-time depends on the temperature delta in between the current motor temperature and the environmental temperature and the connected structure's thermal capacity.

winding temperature (in vacuum), environment 20 °C

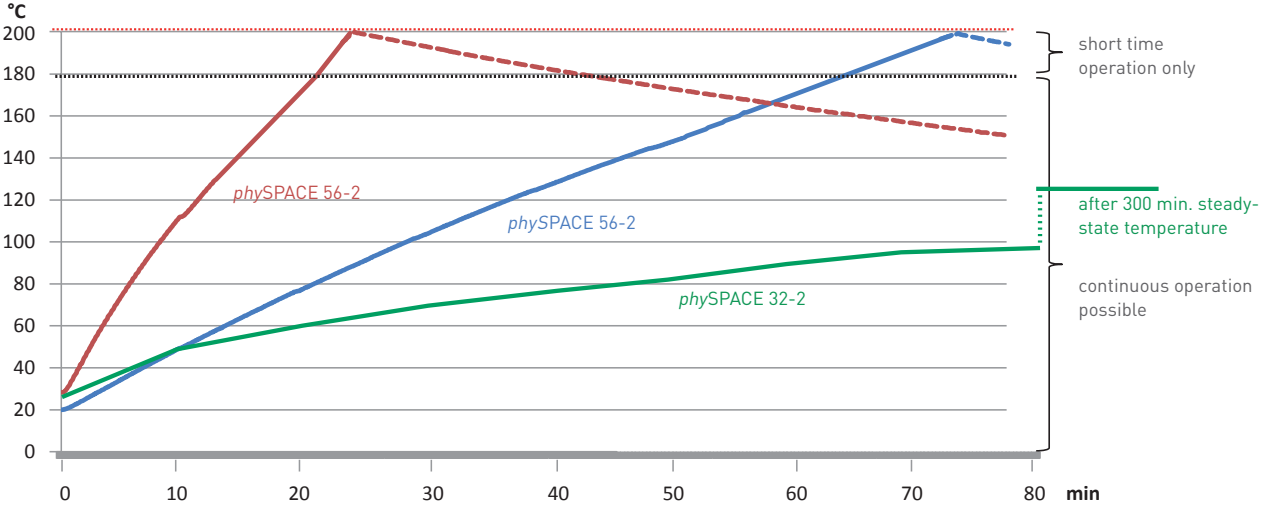

- 1/1 nominal current, 48 V, 400 rpm cooling down
- 1/2 nominal current, 48 V, 400 rpm cooling down
- 1/2 nominal current, 48 V, 200 rpm

Torque Characteristics

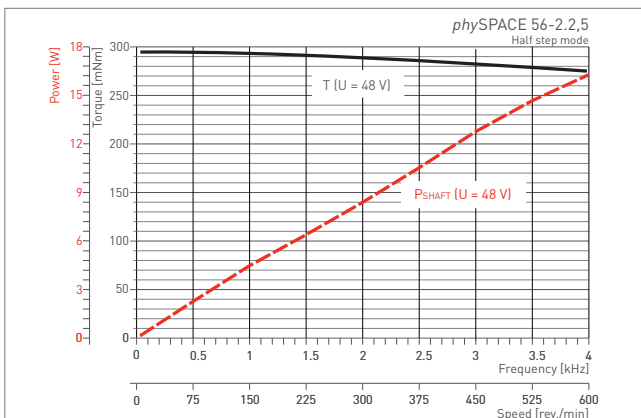
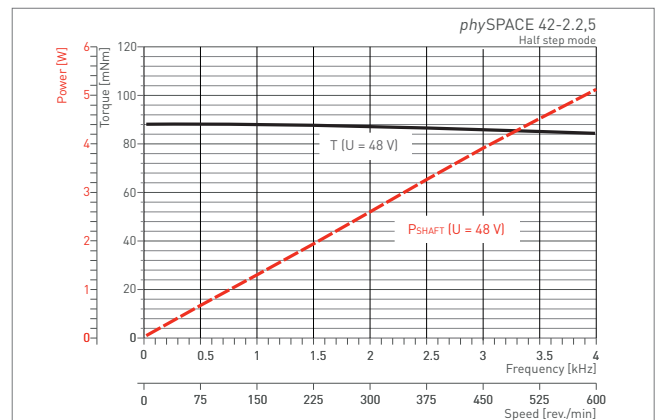
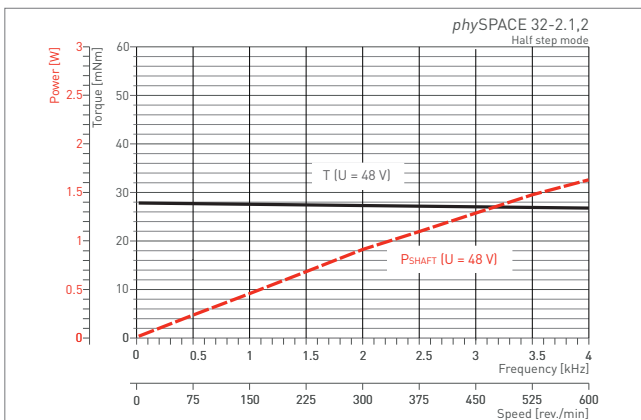
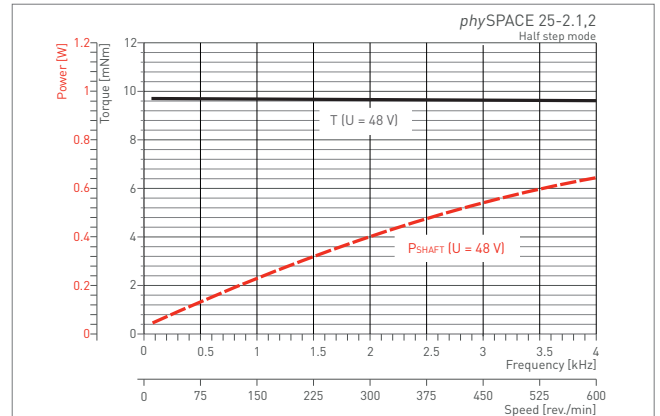
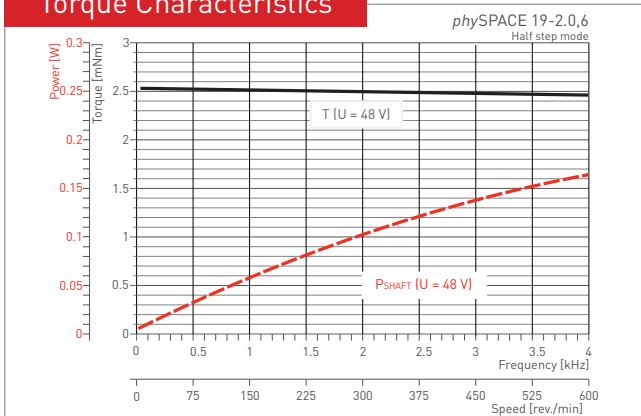

Motor Temperature Sensors: K-type Thermocouple

The insulated temperature sensor in phytron motors is integrated in the motor windings. The response time to temperature changes of the winding is very short, compared to temperature sensors mounted outside the motor housing. The temperature is measured all the time (even if only one motor phase is powered at a time), because the sensor is always mounted between the phases.

Efficient Customising - the Perfect Fit

We proudly contribute to projects of:

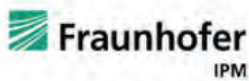

Tailored Stepper Motors for Space Applications



BepiColombo - MERTIS (due to launch in 2015)

MERCURY Radiometer and Thermal Infrared Spectrometer

- Instrument: <http://www.dlr.de/os/desktopdefault.aspx/tabid-6956/>
- Mission: http://www.esa.int/Our_Activities/Space_Science/BepiColombo_overview2
- for: Polish Academy of Science (PAS), DLR, ESA

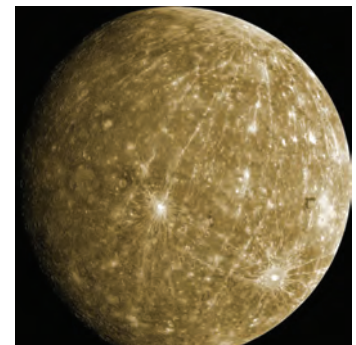

Bepi Colombo

image: NASA



MAVEN (2013)

Launch date: Nov. 18, 2013; mission target: mars - explore its upper atmosphere; orbit insertion date: Sept. 22, 2014

- grating flip mechanism, 90° deflecting angle moving in hard end stops
- cleanliness for optics
- motor: size 25, hybrid stepper 200 steps/rev
- gear: integrated planetary gear ratio 50:1, 90 deg travel
- structural parts titanium, hybrid bearings, lubrication
- titanium coupling: compensation of an axial length reduction during deformation without additional stress
- for LASP / NASA



LASP MAVEN

image: NASA/Goddard Space Flight Center

Tailored Stepper Motors for Space Applications

Mars rover CURIOSITY for NASA (2011)

phytron stepper motor focuses laser and the analysis camera

- focuses the laser light and the analysis camera inside the ChemCam instrument on the sample.
- excels in reliability, durability, vacuum compatibility and minimal outgassing rates.
- optimised for mechanical friendly smooth running and is capable of precise positioning even without feedback or complex electronics



Mars rover CURIOSITY - ChemCam image: NASA



JUNO (2011)

Mirror rotation in Ultraviolet Imaging Spectrograph

- phytron's stepper motor : VSS 32
- Instrument: <http://adsabs.harvard.edu/abs/2008AGUFMSM41B1678G>
- Mission: http://www.nasa.gov/mission_pages/juno/main/index.html
- NASA / ESA



Juno image by NASA/JPL



MIRIS (2010)

Multi-purpose infrared imaging system (MIRIS)

- Instrument: http://www.isas.jaxa.jp/home/rikou/kogata_eisei/symposium/2nd/koto/07.pdf
- for: Astronomy and Space Technology R&D Division, Korea Astronomy and Space Science Institute

Tailored Stepper Motors for Space Applications

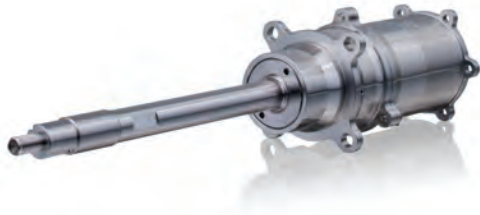

EnMAP mission

Shutter calibration mechanism as part of the scientific payload of the German EnMAP mission.

- customised titanium gear shaft for low weight and strength
- tailored magnet arrangement to minimise stray magnetic flux
- redundant windings cater for loss of primary coils
- Harmonic Drive gears for space conditions
- duplex bearings to better absorb shock and vibration
- central housing configuration for optimised force transmission (hybrid assembly technology)
- for: Kayser-Threde and HTS



A perfect fit for EADS Astrium.

High precision positional actuator for the X-Band Downlink Antenna for the KOMPSAT S/C:

- customised titanium main structure for low weight and optimal strength
- integrated Harmonic Drive gear unit
- duplex bearings to withstand shock and vibration
- special lubrication system to prolong lifetime
- customised leadwire exit to meet project constraints
- motor model endurance tested in vacuum and N2 atmosphere (bearings, lubrication system, gears)



SOLACES (2003)

- stepper motor with 200 steps/revolution (1,8°)
- designed for 300 N axial force
- holding torque 70 mNm / driving torque 60 mNm
- spindle system, non-magnetic
- special grease; designed for ultra high vacuum at -50 °C to +40 °C
- for: IPM Freiburg

Tailored Stepper Motors for Space Applications

Rosetta - Cosima (2004)

Cometary Secondary Ion Mass Analyser

- motor: stepper motors VSS19
- Instrument: <http://www.mps.mpg.de/de/projekte/rosetta/cosima/#instrument>
- Mission: http://www.esa.int/Our_Activities/Space_Science/Rosetta
- for: Max-Max-Planck-Institut, Extraterrestrische Physik München

STEREO (2006)

The sun in 3D

- Mission: http://www.nasa.gov/mission_pages/stereo/main/index.html
- for: NASA + The Johns Hopkins University

XMM-Newton - EPIC (2000)

European Photon Imaging Camera (EPIC)

- Instrument: <http://sci.esa.int/xmm-newton/31281-instruments/?fbodylongid=774>
- Mission: <http://xmm.esac.esa.int/>
- for: Max-Max-Planck-Institut, Extraterrestrische Physik München, ESA

Cassini-Huygens (1997)

Exploring Saturn

- Mission: ESA: http://www.esa.int/Our_Activities/Space_Science/Cassini-Huygens
- Mission: NASA: http://www.nasa.gov/mission_pages/cassini/main/
- for: Max-Planck-Institut, Heidelberg, ESA, NASA

MOS-IRS-P2 (1996)

Indian Remote Sensing Satellite-P2

- Mission: <https://earth.esa.int/web/guest/missions/3rd-party-missions/historical-missions/irs-p3>
- für: DLR

Space

Electrical Connection

4-lead
bipolar control

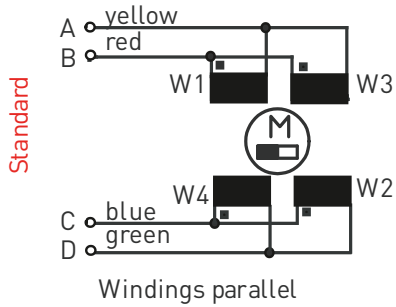

All illustrations, descriptions and technical specifications are subject to modifications; no responsibility is accepted for the accuracy of this information.

Ordering Code

The variable elements of the product are displayed in colour.

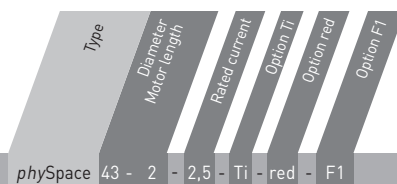

Ordering code phySpace 43 - 2 - 2,5 - Ti - red - F1

Options		
Diameter - Motor size	19 - 2 25 - 2 32 - 2 42 - 2 52 - 2 56 - 2	
Rated current [A/Phase]	0,6 1,2 2,5	for phySPACE 19 to 32 for phySPACE 19 to 56 for phySPACE 42 to 56
Option	Ti	Titanium housing
Option	red	Winding cold redundant
Option	F1	Shaft design flat (front)

Phytron GmbH
Industriestraße 12 – 82194 Gröbenzell
T +49-8142-503-0 F +49-8142-503-190

phytron INTERNATIONAL

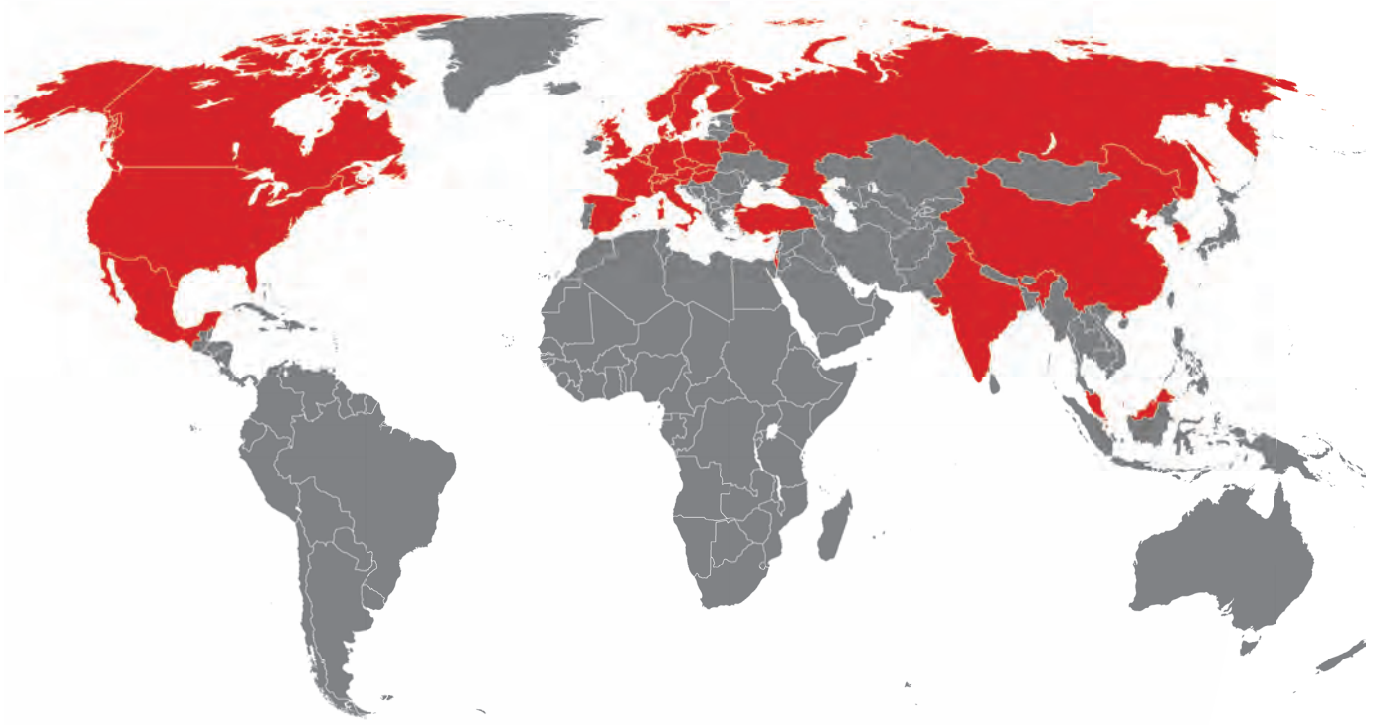

Representatives

Germany

 PLZ 0/1/39/98-99

Dr. Reinhard Siebert
r.siebert@phytron.de
Tel +49 3329 438 9971
Fax +49 3329 614 350

Industrievertretung
Friedrich-Naumann-Str. 80
14532 Stahnsdorf

 PLZ 26-28/30-34/37/38/4/5

Hr. Kevin Buecker
k.buecker@phytron.de
Tel +49 2273 4060 777
Fax +49 8142 503 190

Phytron Nord-West
Erftr. 108
50170 Kerpen

 PLZ 35-36/6/7/8/90-97

Hr. Meinolf Mester
m.mester@phytron.de
Tel +49 6068 4785672
Fax +49 6068 3270

Phytron Süd
Friedrich-Ebert-Str. 15 a
64743 Beerfelden

 PLZ 20-25/29

Hr. Stefan Wohlfeld
s.wohlfeld@phytron.de
Tel +49 8142 503-126
Fax +49 8142 503-190

Phytron GmbH
Industriestr. 12
82194 Gröbenzell

International

 Austria/Hungary

Hr. Gerd Zöhling
info@phytron.at
www.phytron.at
Tel +43 1 888-3177
Fax +43 1 888-3177

Phytron GmbH
Kaltenleutgebner Str. 59
1230 Wien
AUSTRIA

 Denmark

Mr. Björn Davidson
bd@gearcentralen.dk
www.gearcentralen.dk
Tel +45 74 42 18 64
Fax +45 74 42 18 94

GCM A/S
Redstedsgade 15
6400 Sønderborg
DENMARK

 Belarus

Mr. Alexander Semionov
a.semionov@fek.by
www.fek.by/en
Tel +375-17-2102189-4121
Fax +375-17-2102189-4444

FEK Company
Pushkin ave. 29B
220015 Minsk
BELARUS

 France

Mr. Bernard Bizeul
bbizeul@tsa.fr
www.tsa.fr
Tel +33 1 30408-130
Fax +33 1 30408-145

Z.A.E du Parc
6, rue Condorcet
95157 Taverny, Cedex
FRANCE

 Belgium / Luxembourg

Mr. Dirk Benoit
info@benoit.be
www.benoit-industry.be
Tel +32 56 6041 19
Fax +32 56 6105 03

Benoit Elektronika Industrie
Lindestraat 59
8790 Waregem
BELGIUM

 Great Britain

Mr. Carl Huntington
sales@a4automation.co.uk
www.a4automation.co.uk
Tel +44 118 9462132
Fax +44 118 9473059

A4 Automation Ltd.
17 Kingsway, Caversham Park
Reading, Berkshire, RG4 6RA
GREAT BRITAIN

 China

Mr. Gao Wei
info@servodynamics.com.cn
www.servodynamics.com.cn
Tel +86 512 8207-9127
Fax +86 512 8207-9333

Servo Dynamics Co. Ltd.
4th Floor, Block No.1
ISND Holding Ind. Park
1128 East Jiangxing Road
Wujiang Economic Development Zone
215200 Suzhou
PR CHINA

 India

Mr. Ranjit Kambil
sales@orbitalsystems.net
www.orbitalsystems.net
Tel +91 22 284 73312 o. 284 76915
Fax +91 22 284 76675

Orbital Systems (Bombay) Pvt. Ltd
F-129, Ansa Indl. Estate
Saki Naka
Mumbai – 400 072
INDIA

 Czech Republic/Slovakia

Hr. Gerd Zöhling
info@phytron.at
www.phytron.at
Tel +43 1 888-3177
Fax +43 1 888-3177

Phytron GmbH
Kaltenleutgebner Str. 59
1230 Wien
AUSTRIA

 Israel

Mr. Zeev Shaked
bruno@brunocorp.co.il
www.brunocorp.co.il
Tel +972 3 5705-323
Fax +972 3 5705-331

Bruno International Corp.
14, Bar Kochba st.
P.O. Box 855
Bney Berak 51261
ISRAEL

International

 Italy

Mr. Guido Giorgi
info@vacuumfab.it
www.vacuumfab.it
Tel +39 02 365-419 42
Fax +39 02 947-535 77

Vacuum FAB Srl.
Via S. Protaso 39
20010 Bareggio (Mi)
ITALY

 Korea

Mr. Jason Yoon
jyoon@atc4u.co.kr
www.atc4u.co.kr
Tel +82 31 703-3372
Fax +82 31 703-3376

Advanced Technology Corp.
307, Bizenter, SK Techno Park
190-1 Sangdaewon-Dong
Jungwon-Gu
462-807 Gyeonggi-Do
Seongnam-City
KOREA

 Malaysia

Mr. Ng Shan Wee
advancement@yahoo.com
Tel +60 3 8060 6808
Fax +60 3 8060 7808

Advancement Technology Sdn. Bhd.
No. 27, Jalan TPP 1/11
Taman Industri Puchong, Bt 12
47100 Puchong, Selangor
MALAYSIA

 Netherlands

Mr. Frans Nijman
frans.nijman@
morskateaanrijvingen.nl
www.morskateaanrijvingen.nl
Tel +31 74 - 760 11 11
Fax +31 74 - 760 11 19

Morskate Aandrijvingen B.V.
Oosterveldsingel 47A
7558 PJ Hengelo (Ov)
NETHERLANDS

 Poland

Dr. Reinhard Siebert
r.siebert@phytron.de
Tel +49 3329 438 9971
Fax +49 3329 614 350

Industrievertretung
Friedrich-Naumann-Str. 80
14532 Stahnsdorf
GERMANY

 Russia

Mr. Alexander G. Gordyuk
info@microprivod.ru
www.microprivod.ru
Tel +7 495 221 40 52
Fax +7 495 221 40 52

Microprivod Ltd.
56 (bldg.32) Shosse Enthus. 1-3
11123 Moscow
RUSSIA

 Sweden/Norway/Finland

Mr. Oscar Nyström
info@motor.oem.se
www.oemmotor.se
Tel +46 75 242 4400
Fax +46 75 242 4449

OEM Motor AB
Fredriksbergsgatan 2
57392 Tranås
SWEDEN

 Switzerland

Hr. Hans Vogt
info@zivotron.ch
www.zivotron.ch
Tel +41 52 3763-005
Fax +41 52 3763-007

Zivotron GmbH
Morgenstrasse 11
8512 Thundorf
SWITZERLAND

 Singapore

Mr. Andrew Tan
umccst@singnet.com.sg
Tel +65 635377-90
Fax +65 635377-39

Unimotion Controls Pte. Ltd.
Kaki Bukit Avenue 3,
KB-1 #06-18
416087 Singapore
SINGAPORE

 Slovenia

Mr. Brane Ozebek
brane.ozebek@domel.si
www.domel.si
Tel +386 45117-358
Fax +386 45117-357

DOMEL d.o.o.
Otoki 21
4228 Zelezniki
SLOVENIA

 Spain

Mr. Jose M.ª Sitges Carreño
jmsitges@sinerges.com
www.sinerges.com
Tel +34 93 6633-500
Fax +34 93 6633-501

Sinerges Tecmon SA.
Ronda de Santa Eulalia, 35-37
Naves 2 - 3
08780 Pallejà (Barcelona)
SPAIN

 Turkey

Mr. Ahmet Üzümcü
main@yrmotomasyon.com
www.yrmotomasyon.com
Tel +90 212 51722-70
Fax +90 212 51722-73

YRM Otomasyon as.
Atalar Cad
Dolunay Sok. No: 5
34862 Kartal, Istanbul
TURKEY

 USA/Canada/Mexico

Mr. Wahid Lahmadi
wahid@phytron.com
www.phytron.com
Tel +1-802 872-1600
Fax +1-802 872-0311

Phytron, Inc.
600 Blair Park Road
Suite 220
Williston, VT 05495
USA

Representatives