

**AC
Motors**

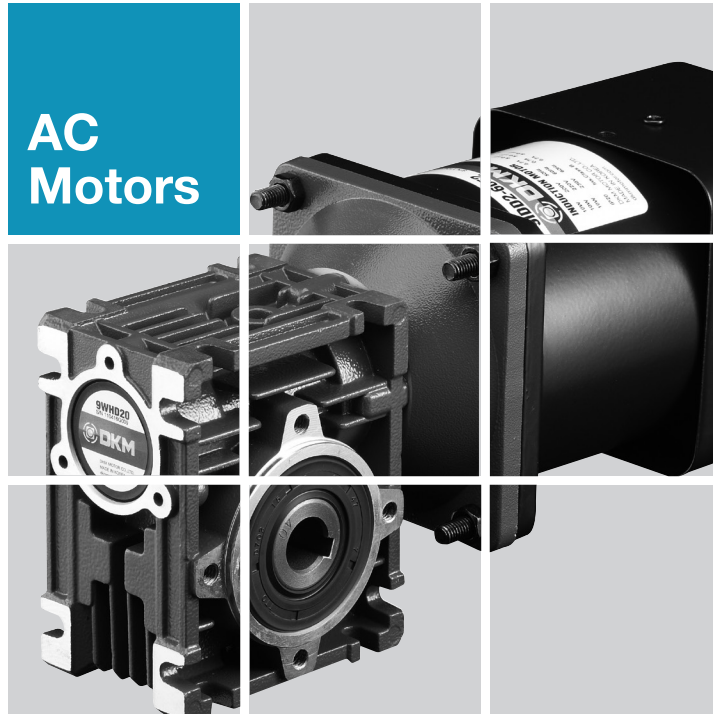

Contents ▶▶

A Information

- A-01 Product Coding System
- A-04 Products Lineup
- A-08 General Information
- A-12 Terminology
- A-15 Caution for Using

B AC Motors

- B-01 Technical Data of AC Motor
- B-06 Induction Motor
- B-56 2 Pole Motor
- B-74 Reversible Motor
- B-106 Brake Motor
- B-148 Clutch & Brake Motor
- B-162 Torque Motor
- B-176 Speed Control System
 - B-179 Speed Controller FX1000A
 - B-181 Speed Controller DSKM
 - B-186 Speed Control Induction Motor
 - B-222 Speed Control Reversible Motor
 - B-250 Speed Control Brake Motor
 - B-276 Speed Control Clutch & Brake Motor

C DC Motors

- C-01 Technical Data of DC Motor
- C-04 DC Motor
- C-17 Speed Controller DSD-90

D Gearboxes

- D-01 Technical Data of Gearbox
- D-07 Parallel Gearbox
- D-13 Worm Gearbox
- D-16 Inter-decimal Gearbox

E Options

- E-01 Mounting Plate
- E-02 Extension Cable
- E-03 Output Flange / Output Shaft

Definition of Motor

Motor is a machine to get a driving force for rotation or straight movement by converting the electrical energy into mechanical energy and the light-weighted motor which enables to select the model suitable for the load, has less noise and vibration as well as no exhaust pollution.

Features of DKM AC Motor

DKM AC geared motor was developed first in Korea in 1987 and has been used in a good reputation throughout the whole areas of domestic/overseas industry up to know. Our AC geared motor is proud of various and wide range of specification which satisfies various electrical requirements from all over the world.

Various and Abundant Models

- There are various and abundant models in frame size covering □ 60/70/80/90mm such as Induction Motor, 2 Pole Motor, Reversible Motor, E.M. Brake Motor, Clutch & Brake Motor, Torque Motor and Speed Control Motor.
- For use voltage, we have various voltage specification covering all areas in the globe: 100V 50/60Hz(Japan), 200V 50/60Hz(Japan), 110V 60Hz(Taiwan), 220V 60Hz(Korea, Taiwan), 115V 60Hz(North America), 230V 50Hz(Europe, Oceania), 220V/240V 50Hz(South-East Asia)

Low Noise and Low Vibration

- Due to the enhancement of quality standard such as places and conditions for motors to use, the low noise and low vibration are required.
- To satisfy these conditions, we employed high precision of gear processing and skiving cutting method and we are making a rotor which is the root cause of vibration by verifying with balance machine for low noise and low vibration.

Easy to Use

- Easy and safe to use as motor and Gearbox are sold according to the requirements so that it can be designed and manufactured optimally.
- It is easy to drive to get a driving force by connecting capacitor to the commercial power available to be used anywhere and anytime. As capacitor is not needed for three phase power, it is available to get a driving force easily by connecting three phase power to the motor directly.

Just-In-Time System

- Just-In-Time system is available in DKM Motor Co., Ltd. for the best delivery system. DKM realized user's satisfaction with the world best delivery system.

Types of Motor

Classification by Power

- **AC motor:** A motor operated by AC power. For example, inductive motor, synchronous motor, AC commutator motor etc.

1) Single Phase Motor

- Single phase power is composed of one phase as commercial power for home.
- As power itself does not make motor rotate, capacitor is connected to auxiliary coil to start.

2) Three Phase Motor

- Three phase motor stands for electrical power and it is consisted of three electrical sources with a phase offset of 120° in voltage.
- Connect the power to motor to start and the rotor will start to run easily.
- The efficiency of motor is high and the starting torque is relatively big.

- **DC motor:** A motor which rotates by supplying the direct current to the armature. The torque generated by placing the coil between magnetic poles N and S and applying the current to this coil rotates the motor. Whenever this coil passes the neutral shaft, it turns the direction of current reversely and rotates continuously

Classification by Function

● Motor with Constant Speed

1) Induction Motor: An induction motor is a type of AC motor where power is supplied to the rotor by means of electromagnetic induction. These motors are widely used in industrial drives, particularly polyphase induction motors, because they are rugged and have no brushes. Their speed is determined by the frequency of the supply current, so they are most widely used in constant-speed applications, although variable speed versions, using variable frequency drives are becoming more common.

2) Reversible Motor: A kind of induction motor and a motor having the same characteristic in any direction such as left turn or right turn. In principle, it is same as induction motor but there is no relation of main coil and auxiliary coil like general induction motor in order to stand frequent normal/reverse rotation and get a big starting torque.

● Brake Motor

It is a motor embedded with fail-safe electromagnetic brake. Perfect braking enables to get a staying power. Brake runs only when the power is shutdown, so this is suitable as a brake for safe use.

※ DKM has 'A Type' electronic brake motor which runs when the power is applied. (Customized specification)

● Clutch & Brake Motor

DKM Clutch & Brake motor is equipped with Clutch & Brake mechanism available to be used with Gearbox. As the continuously rotating induction motor and Clutch & Brake are combined, this can be used for frequent start/stop, position control, index operation and relative value feeding operation etc.

● Torque Motor

DKM torque motor has big starting torque and sloping characteristics. It runs safely over the whole area of rotation speed-torque characteristics. (Torque is highest at zero speed and decreases steadily with increasing speed.) With these characteristics, this can be used for more application as a winding or tension motor.

● Speed Control Motor

User can easily set and adjust the motor speed. There are three kinds of speed controller for AC speed motors. Select the best system depending upon your application.

Structure of AC Motor

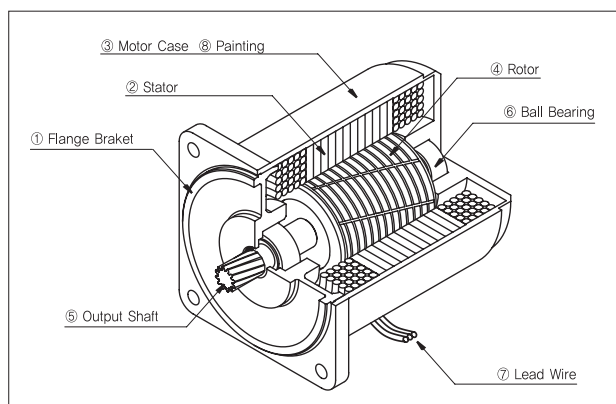

① Flange Bracket

Die-cast aluminum bracket is press-fitted into the motor case. The flange and the housing are a single body type which plays an important part to attach the motor alone or combine the Gearbox.

② Stator

This is comprised of a stator core made from laminated silicon/steel plates, a polyester-coated copper coil and insulation film. The roles are to generate magnetic field, form the rotation and run the rotor.

③ Motor Case

Die-cast aluminum with a machined finish inside

④ Rotor

It is comprised of laminated silicon/steel plates with die-cast aluminum. Rotor plays the part to change the electric energy to mechanical energy and transfer it to outside through shaft.

⑤ Output Shaft

There are D-cut type shaft, key type shaft which are for using by motor itself and gear type shaft (pinion shaft) which is for attaching Gearbox. It is made by S45C with a machined finish.

⑥ Ball Bearing

It ensures that the rotor remains at the right position for the reliability and fast rotational motion.

⑦ Lead Wire

Lead wires with heat-resistant polyethylene coating

⑧ Painting

Backed finish of acrylic resin and melamine resin with beautiful look

Temperature Rise of AC Motor

Temperature Rise

- In operation of motor, the loss inside of motor is changed to heat causing the motor's temperature to rise.
 - Induction Motor (for continuous duty) reaches the saturation point of temperature rise in about two or three hours of operation and temperature stabilizes.
 - Reversible Motor (30 minutes rating) reaches their limit of temperature rise in about 30 minutes of operation. If operation continues as it is, the temperature will increase further.

Measuring Temperature Rise

- DKM uses the following methods for temperature measurement and for the determination of a motor's allowable temperature rise.
 - Thermometer Method: The temperature rise at which the temperature rise becomes saturated during motor operation is measured by using a thermometer or thermocouple installed in the center of the motor case. The temperature rise is the difference between the ambient temperature and measured temperature during motor operation.
 - Resistance Method: This is the way of measuring the winding temperature according to the change in resistance value. The motor's winding resistance and ambient temperature is measured by using a resistance meter and thermostat.

Overheating Protection Device

- In case of that a running motor locks due to overload or the input current increases due to any reason or ambient temperature increases suddenly, the motor's temperature rises abruptly. If this state continues, the insulation performance may deteriorate and, in extreme cases, it may cause a fire. To avoid this case, DKM employs the following overheating protection devices.
 - **Thermal Protector (TP)**
DKM installs the thermal protector for overheating protection of the motor. The TP employs a bimetal contact with pure silver used in the contacts. Pure silver has the lowest electrical resistance of all materials and has thermal conductivity second only to copper. (Operating Temperature: Open 120°C±5°C / Close 90°C±5°C)
 - **Impedance Protection**
Impedance-protected motor has higher impedance in the motor windings so although the motor locks, the increase in input current is minimized and temperature will not rise.

Insulation Class

- DKM Motor's insulation class is B class. Insulation class is according to heat-resistance class. According to JIS C4003(IEC60085), it is defined as below. It is also available to use other materials for some particular insulation class according to operating conditions or user's request. (Customized specification)

Insulation Class	Max. Permissible Temp.
Y	90°C
A	105°C
E	120°C
B	130°C
F	155°C
H	180°C

FAN

- It is available to attach two kinds of fan to the DKM's motor; 'General Fan (F type)' and 'Powerful Fan (F2 type)'.
General fan is attached to motor shaft rotating in same speed as that of motor shaft. (1,800r/min in 60Hz, 1,500r/min in 50Hz) Powerful fan makes powerful cooling performance rotating in high speed regardless of motor shaft speed. (3,200r/min in 60Hz. Temperature reducing over 10°C is available comparing general fan.)
DKM employs general fan to the motors with continuous speed and employs powerful fan by customers' special order to the continuous speed's motor. But in case of speed control motor in which speed control is needed, powerful fan is employed basically because there is little cooling effect in low speed if general fan is used.

Equipment Protection Structure (IP Code)

- The IP code is one of the equipment protection structures and indicates the dust-resistance and waterproofing degrees of protection for the equipment.
- The code consists of the first number and the second number.

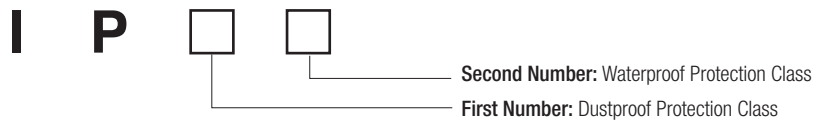

- "X" is used when one of the two protection classes is not specified in the name. (e.g. IPX5, IP4X)
- Meanings of IP code and testing conditions are as below;

1) The Classification of Dustproof

IP Code	Protection Specifications for Dustproof	
First Number	Protection Level	Test Condition
IP0□	None	None
IP1□	Protection against approach by hands	Solid objects with a diameter of 50mm or more do not enter.
IP2□	Protection against approach by fingers	Solid objects with a diameter of 12mm or more do not enter.
IP3□	Protection against tips of tools etc.	Solid objects with a diameter of 2.5mm or more do not enter.
IP4□	Protection against ingress of wires etc.	Solid objects with a diameter of 1.0mm or more do not enter.
IP5□	Protection against powdery dust	Powdery dust that may inhibit normal operation does not enter.
IP6□	Completely dustproof design	Cannot be penetrated by powdery dust.

2) The Classification of Waterproof

IP Code	Protection Specifications for Waterproof	
Second Number	Protection Level	Test Condition
IP□0	None	None
IP□1	Protection against water drops falling vertically	Water drops at a rate of 3 to 5L/min. for 10 minutes from a height of 200mm
IP□2	Protection against water drops from directions within a range of 15° relative to the vertical plane	Water drops at a rate of 3 to 5L/min. for 10 minutes from directions within 15° from a height of 200mm
IP□3	Protection against raindrops from directions within a range of 60° relative to the vertical plane	Sprayed water at a rate of 10L/min. for 10 minutes from directions within 60° from a height of 200mm
IP□4	Protection against ingress of splashes from all directions	Sprayed water at a rate of 10L/min. for 10 minutes from all directions at a distance of 300 to 500mm
IP□5	Protection against water jet from all directions	Sprayed water jet of 30kPa at a rate of 12.5L/min. for 3 minutes from all directions at a distance of 3m
IP□6	Protection against strong water jet such as ocean waves	Sprayed water jet of 100kPa at a rate of 100L/min. for 3 minutes from all directions at a distance of 3m
IP□7	Usable after immersion in water under specified conditions	Immersion to a depth of 1m for 30 minutes
IP□8	Usable under water	Determined through cooperation between user and manufacturer.

- The IP code of DKM's motor is indicated in the name plate (motor label).

Earth Method

Lead Wire Type

- As shown in the figure, connect the earth wire to the earth hole in the side of the motor.
Screw the earth wire to the earth hole. (Sequence: earth hole → washer → earth wire → screw bolt)

Terminal Box Type

- Connect the earth wire to the earth terminal in the terminal box.

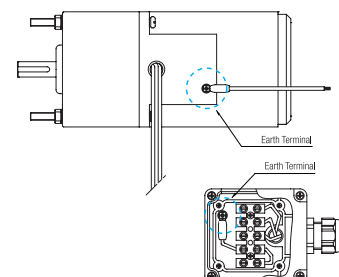



Induction Motor



Induction Motor

Index

Outline of Induction Motor	B-07
Induction Motor 6W (□ 60mm)	B-09
Induction Motor 6W (□ 70mm)	B-11
Induction Motor 10W (□ 70mm)	B-13
Induction Motor 15W (□ 70mm)	B-15
Induction Motor 15W (□ 80mm)	B-17
Induction Motor 25W (□ 80mm)	B-20
Induction Motor 40W (□ 90mm)	B-23
Induction Motor 60W (□ 90mm)	B-26
Induction Motor 90W (□ 90mm)	B-30
Induction Motor 120W (□ 90mm)	B-34
Induction Motor 150W (□ 90mm)	B-38
Induction Motor 180W (□ 90mm)	B-41
Induction Motor 200W (□ 90mm)	B-44
Induction Motor 250W (□ 104mm)	B-47
Induction Motor 300W (□ 104mm)	B-50
Induction Motor 400W (□ 104mm)	B-53

B AC Motors

Outline of Induction Motor

☐ Suitable for Unidirectional Continuous Operation

- Induction motors are suitable for unidirectional continuous operation such as conveyor belt system.

☐ Single Phase Run

- For the running of a single phase motor, please use the capacitor complying with the capacity of the motor. For a single phase induction motor, it is not possible to reverse the direction within a short time during operation. So stop the motor first and change the direction next. (Figure 1)

☐ Three Phase Run

- Three phase induction motor has relatively high starting torque comparing single phase motor and has high reliability because it can be directly operated by a three phase power source. (Figure 2)

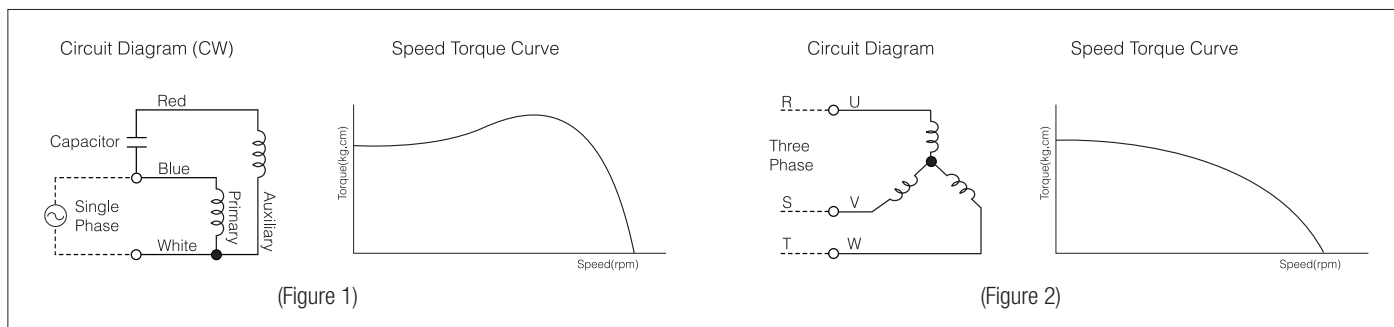

☐ The Relation between Speed and Torque

- In a condition of constant power voltage, the relation between speed and torque is like next figure. Under the condition of no-load, the number of rotation is roughly same as the number of synchronous rotation. But if the load increases, the number of rotation decreases and approaches to the speed (r/min) indicated by the point P where the torque T_p horizontally meets the load curve. When the load further increases and reaches the point M, the motor stops at the point R because the motor no longer generates further torque. Therefore, the leg R-M is referred to as an unstable zone and the leg O-M is a stable zone for operation.

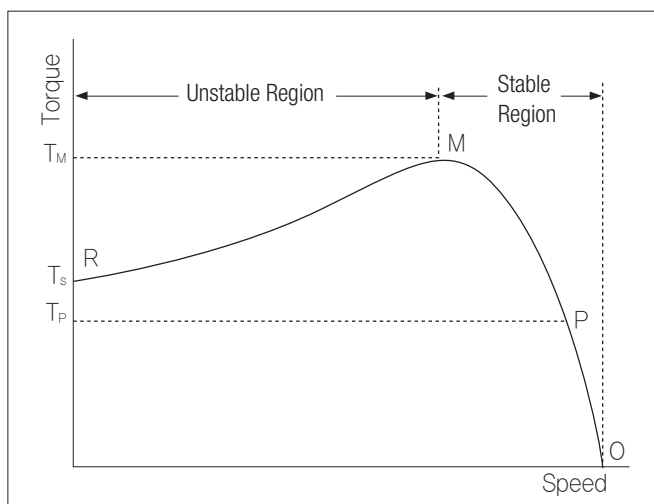

☐ Features of Voltage and Capacitor

- Generally the torque of induction motor changes proportionate to twice the voltage and it also changes according the capacity of the capacitor. If the capacity of the capacitor increases, the starting torque and rated torque will increase. But if the capacity increases by over 2 times, the rated torque decreases and starting torque do not increase. When the induction motor is short on torque, it is possible to increase the torque by increasing the voltage or the capacity of the capacitor to continue the operation. But please be informed that in this case the loss input of the motor increases and the temperature rises rapidly. However, if the motor must be run with insufficient torque, take measures to let the motor release heat as much as possible by installing separate fan as an example and operate the motor while keeping the temperature of the motor's housing below 90°C .

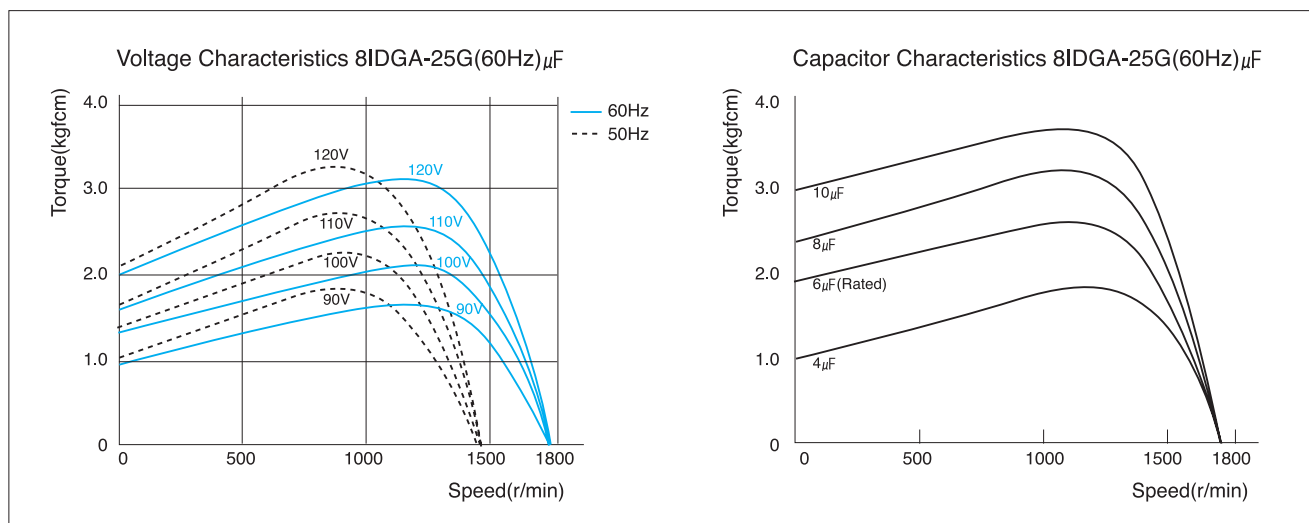

General Specifications

Item	Specification
Insulation Resistance	100M Ω or more when DC500V MEGA is applied between the windings and the frame after rated motor operation under normal ambient temperature and humidity.
Dielectric Strength	Sufficient to withstand 1.5KV at 50Hz and 60Hz applied between the windings and the frame for 1 minute after rated motor operation under normal ambient temperature and humidity.
Temperature Rise	Temperature rise of windings are 80 $^{\circ}$ C or less measured by the resistance change method after rated motor operation with connecting a Gearbox or equivalent heat radiation plate.
Insulation Class	Class B [130 $^{\circ}$ C]
Overheat Protection	Operating temperature (Built-in thermal protector type motor): Open 120 $^{\circ}$ C \pm 5 $^{\circ}$ C, Close 90 $^{\circ}$ C \pm 5 $^{\circ}$ C
Ambient Temperature	-10 $^{\circ}$ C \sim +40 $^{\circ}$ C (Three phase 220VAC: -10 $^{\circ}$ C \sim +50 $^{\circ}$ C)
Ambient Humidity	85% maximum

Connection Diagrams

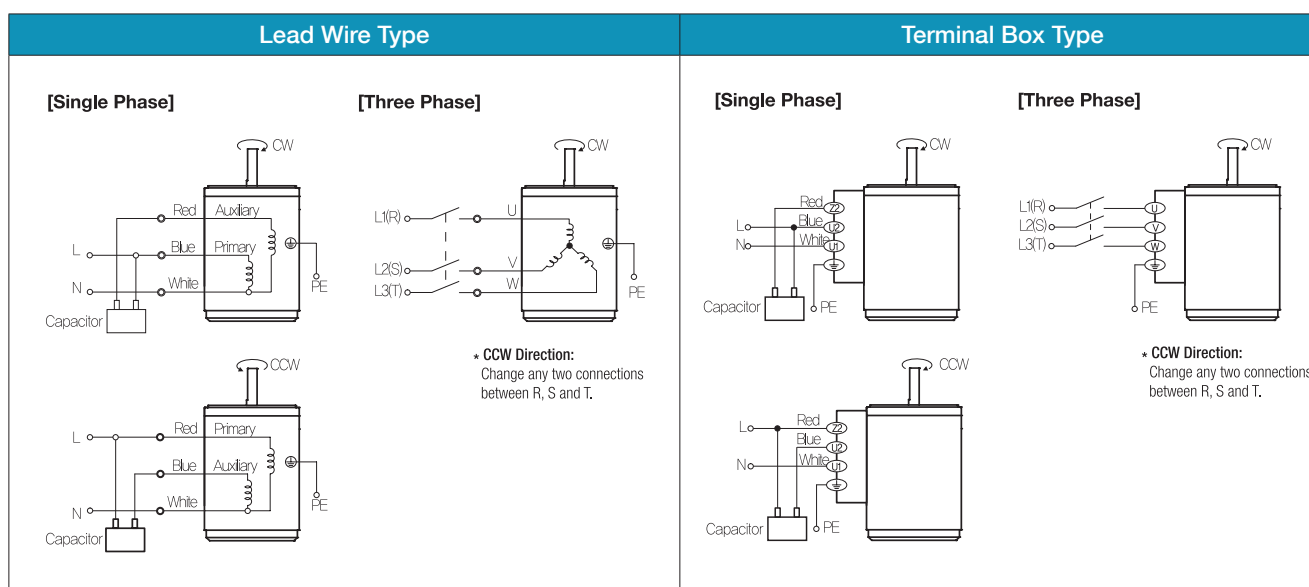

B AC Motors

Induction Motor 6W(□60mm)

6W

Induction Motor
6W(□60mm)

Motor Specification

Model		Output	Voltage	Frequency	Poles	Duty	Starting Torque		Rated Load			Capacitor	
Lead Wire Type	Terminal Box Type						kgfcm	N.m	Speed	Current	Torque		μF / VAC
6IDG□-6G(-T): Gear Type Shaft 6IDD□-6(-T): D-Cut Type Shaft		W	V	Hz					r/min	A	kgfcm	N.m	
6IDGA-6G	6IDGA-6G-T	6	1∅110	60	4	Cont.	0.42	0.042	1500	0.20	0.42	0.042	2.5 / 250
6IDGD-6G	6IDGD-6G-T	6	1∅220	60	4	Cont.	0.56	0.056	1550	0.10	0.42	0.042	0.7 / 450
6IDGE-6G	6IDGE-6G-T	6	1∅220	50	4	Cont.	0.42	0.042	1200	0.09	0.43	0.043	0.6 / 450
			1∅240				0.50	0.050		0.10	0.47	0.074	

- 1) Enter the phase & voltage code in the box (□) within the motor model name.
- 2) This model is impedance protected type.
- 3) Gear Type Shaft is for attaching Gearbox and D-Cut Type Shaft is for using motor only.

Max. Permissible Torque at Output Shaft of Gearbox

60Hz

Motor Model	Gearbox Model	Gear Ratio	3	3.6	5	6	7.5	9	10	12.5	15	18	20	25	30	36	40	50	60	75	90	100	120	150	180
			r/min	600	500	360	300	240	200	180	144	120	100	90	72	60	50	45	36	30	24	20	18	15	12
6IDG□-6G	6GBD□MH	kgfcm	1.0	1.3	1.7	2.1	2.6	3.1	3.5	4.4	5.2	6.3	6.3	7.9	9.5	11.3	12.6	14.3	17.1	21.4	25.7	28.6	30.0	30.0	30.0
		N.m	0.10	0.12	0.17	0.20	0.26	0.31	0.34	0.43	0.51	0.61	0.62	0.77	0.93	1.11	1.23	1.40	1.68	2.10	2.52	2.80	2.94	2.94	2.94
6IDG□-6G	6GBD□MH	kgfcm	30.0	30.0																					
		N.m	2.94	2.94																					

50Hz

Motor Model	Gearbox Model	Gear Ratio	3	3.6	5	6	7.5	9	10	12.5	15	18	20	25	30	36	40	50	60	75	90	100	120	150	180
			r/min	500	417	300	250	200	166	150	120	100	83	75	60	50	41	37	30	25	20	16	15	12	10
6IDG□-6G	6GBD□MH	kgfcm	1.2	1.4	2.0	2.3	2.9	3.5	3.9	4.9	5.9	7.0	7.1	8.8	10.6	12.7	14.1	16.0	19.2	24.0	28.8	30.0	30.0	30.0	30.0
		N.m	0.11	0.14	0.19	0.23	0.29	0.34	0.38	0.48	0.57	0.69	0.69	0.86	1.04	1.24	1.38	1.57	1.88	2.35	2.82	2.94	2.94	2.94	2.94
6IDG□-6G	6GBD□MH	kgfcm	30.0	30.0																					
		N.m	2.94	2.94																					

- 1) Enter the phase & voltage code in the box (□) within the motor model name.
- 2) Enter the gear ratio in the box (□) within the Gearbox model name.
- 3) A colored background indicates gear shaft rotation in the same direction as the motor shaft; a white background indicates rotation in the opposite direction.
- 4) The rotating speed is calculated by dividing the motor's synchronous speed (50Hz: 1,500r/min, 60Hz: 1,800r/min) by the gear ratio. The actual speed is 2~20% less than the displayed value, depending on the size of the load.

Motor Images



Dimensions

MOTOR ONLY

- MOTOR MODEL: 6IDD□-6(-T) (NO FAN)

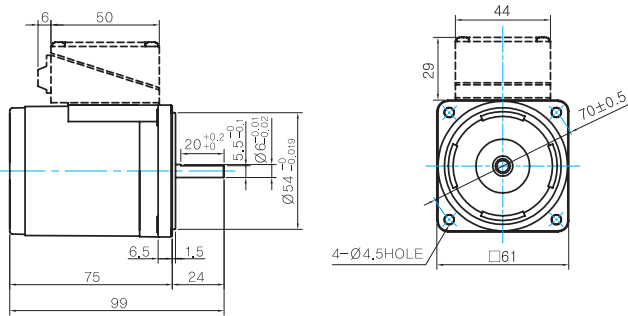

- MOTOR OUTPUT SHAFT

MODEL	SPEC
D-CUT TYPE	

GEARED MOTOR

G TYPE GEARBOX

- MOTOR MODEL: 6IDG□-6G (NO FAN)

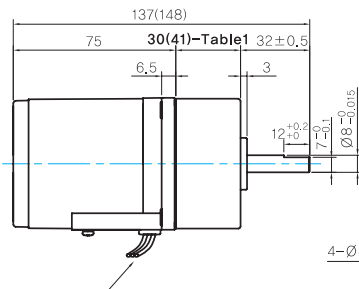

- GEARBOX MODEL: 6GBD□MH

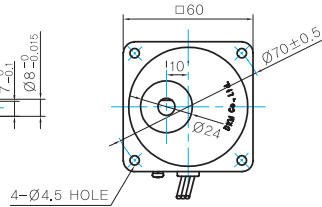

LEAD WIRE 300mm
UL STYLE NO.3266 AWG NO.20

- GEARBOX OUTPUT SHAFT

MODEL	SPEC
D-CUT TYPE	

WEIGHT

PART	WEIGHT(kg)	
MOTOR	0,7	
GEAR BOX	6GBD3MH ~ 6GBD18MH	0,3
	6GBD20MH ~ 6GBD40MH	0,32
	6GBD50MH ~ 6GBD250MH	0,34

- 30(41)-Table1

SIZE(mm)	GEAR RATIO
30	6GBD3MH - 6GBD18MH
41	6GBD20MH - 6GBD250MH

Connection Diagrams

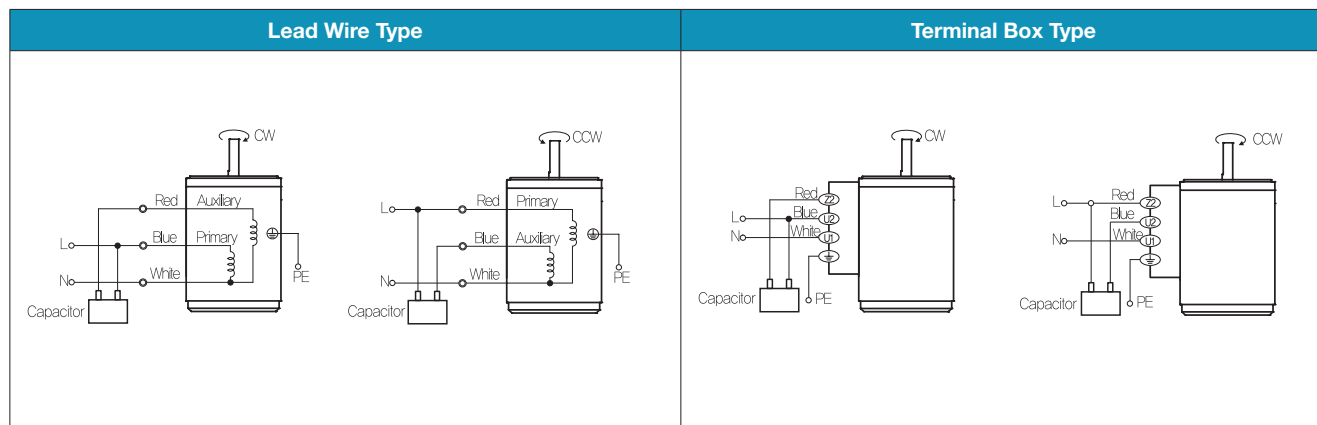

- The direction of motor rotation is as viewed from the shaft end of the motor. 2) CW represents the clockwise direction, while CCW represents the counterclockwise direction.
- Change the direction of single phase motor rotation only after bringing the motor to a stop. If an attempt is made to change the direction of rotation while the motor is rotating, the motor may ignore the reversing command or change its direction after some delay.

B AC Motors

Induction Motor 6W(□70mm)

6W

Induction Motor
6W(□70mm)

Motor Specification

Model		Output W	Voltage V	Frequency Hz	Poles	Duty	Starting Torque		Rated Load			Capacitor μF / VAC	
Lead Wire Type	Terminal Box Type						kgfcm	N.m	Speed r/min	Current A	Torque kgfcm N.m		
7IDG□-6G(-T): Gear Type Shaft 7IDD□-6(-T): D-Cut Type Shaft													
7IDGA-6G	7IDGA-6G-T	6	1∅110	60	4	Cont.	0.53	0.053	1600	0.30	0.41	0.041	2.5 / 250
7IDGD-6G	7IDGD-6G-T	6	1∅220	60	4	Cont.	0.54	0.054	1550	0.16	0.55	0.055	0.7 / 450
7IDGE-6G	7IDGE-6G-T	6	1∅220	50	4	Cont.	0.57	0.057	1250	0.13	0.60	0.060	0.7 / 450
			1∅240				0.67	0.067		0.15	0.70	0.070	

- 1) Enter the phase & voltage code in the box (□) within the motor model name.
- 2) All models contain a built-in thermal protector.
- 3) Gear Type Shaft is for attaching Gearbox and D-Cut Type Shaft is for using motor only.

Max. Permissible Torque at Output Shaft of Gearbox

60Hz

Motor Model	Gearbox Model	Gear Ratio	3	3.6	6	7.5	9	12.5	15	18	25	30	36	50	60	75	90	100	120	150	180
			r/min	600	500	300	240	200	144	120	100	72	60	50	36	30	24	20	18	15	12
7IDG□-6G	7GBK□BMH	kgfcm	1.4	1.6	2.7	3.4	4.1	5.7	6.8	8.2	10.3	12.4	13.5	18.7	22.4	28.1	33.7	37.4	44.9	50.0	50.0
		N.m	0.13	0.16	0.27	0.34	0.40	0.56	0.67	0.81	1.01	1.21	1.32	1.83	2.20	2.75	3.30	3.67	4.40	4.9	4.9

50Hz

Motor Model	Gearbox Model	Gear Ratio	3	3.6	6	7.5	9	12.5	15	18	25	30	36	50	60	75	90	100	120	150	180
			r/min	500	416	250	200	166	120	100	83	60	50	41	30	25	20	16	15	12.5	10
7IDG□-6G	7GBK□BMH	kgfcm	1.7	2.1	3.5	4.4	5.2	7.3	8.7	10.5	13.1	15.8	17.1	23.8	28.6	35.7	42.8	47.6	50.0	50.0	50.0
		N.m	0.171	0.20	0.34	0.43	0.51	0.71	0.85	1.02	1.29	1.54	1.68	2.33	2.80	3.50	4.20	4.66	4.9	4.9	4.9

- 1) Enter the phase & voltage code in the box (□) within the motor model name.
- 2) Enter the gear ratio in the box (□) within the Gearbox model name.
- 3) A colored background indicates gear shaft rotation in the same direction as the motor shaft; a white background indicates rotation in the opposite direction.
- 4) The rotating speed is calculated by dividing the motor's synchronous speed (50Hz: 1,500r/min, 60Hz: 1,800r/min) by the gear ratio. The actual speed is 2~20% less than the displayed value, depending on the size of the load.

Motor Images

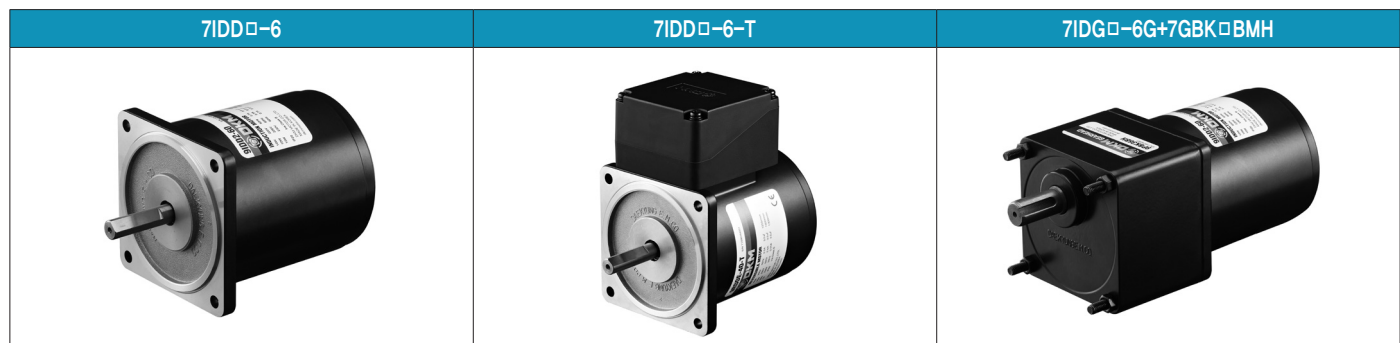

Dimensions

MOTOR ONLY

- MOTOR MODEL: 7IDD□-6(-T) (NO FAN)

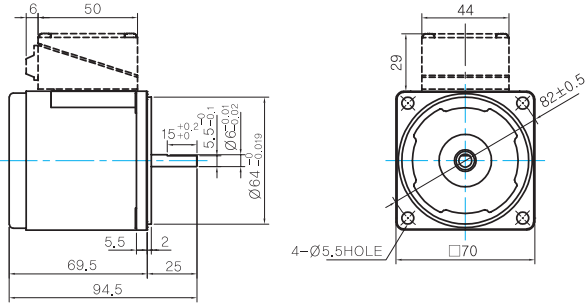

MOTOR OUTPUT SHAFT

MODEL	SPEC
D-CUT TYPE	

GEARED MOTOR

G TYPE GEARBOX

- MOTOR MODEL: 7IDG□-6G (NO FAN)

- GEARBOX MODEL: 7GBK□BMH

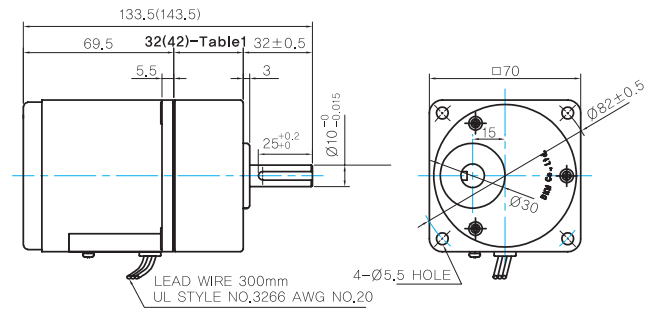

GEARBOX OUTPUT SHAFT

MODEL	SPEC
KEY TYPE	

KEY SPEC

GEARBOX

WEIGHT

PART	WEIGHT(Kg)	
MOTOR	0,84	
GEAR BOX	7GBK3BMH - 7GBK18BMH	0,36
	7GBK25BMH - 7GBK30BMH	0,44
	7GBK36BMH - 7GBK180BMH	0,5

32(42)-Table1

SIZE(mm)	GEAR RATIO
32	7GBK3BMH - 7GBK18BMH
42	7GBK25BMH - 7GBK180BMH

Connection Diagrams

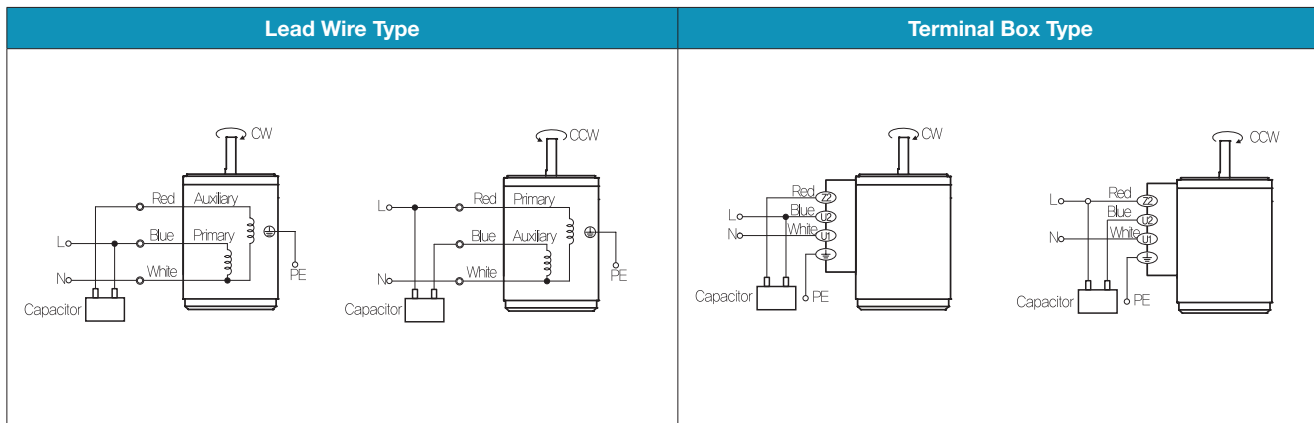

- The direction of motor rotation is as viewed from the shaft end of the motor. 2) CW represents the clockwise direction, while CCW represents the counterclockwise direction.
- Change the direction of single phase motor rotation only after bringing the motor to a stop. If an attempt is made to change the direction of rotation while the motor is rotating, the motor may ignore the reversing command or change its direction after some delay.

B AC Motors

Induction Motor 10W(□70mm)

10W

Induction Motor
10W(□70mm)

Motor Specification

Model		Output	Voltage	Frequency	Poles	Duty	Starting Torque		Rated Load			Capacitor	
Lead Wire Type	Terminal Box Type						kgfcm	N.m	Speed	Current	Torque		
7IDG□-10G(-T): Gear Type Shaft 7IDD□-10(-T): D-Cut Type Shaft		W	V	Hz				r/min	A	kgfcm	N.m	μF / VAC	
7IDGA-10G	7IDGA-10G-T	10	1∅110	60	4	Cont.	0.65	0.065	1500	0.32	0.70	0.070	3.0 / 250
7IDGD-10G	7IDGD-10G-T	10	1∅220	60	4	Cont.	0.84	0.084	1550	0.17	0.69	0.069	1.0 / 450
7IDGE-10G	7IDGE-10G-T	10	1∅220	50	4	Cont.	0.62	0.062	1200	0.14	0.75	0.075	0.8 / 450
			1∅240				0.74	0.074		0.15	0.84	0.084	

- 1) Enter the phase & voltage code in the box (□) within the motor model name.
- 2) All models contain a built-in thermal protector.
- 3) Gear Type Shaft is for attaching Gearbox and D-Cut Type Shaft is for using motor only.

Max. Permissible Torque at Output Shaft of Gearbox

60Hz

Motor Model	Gearbox Model	Gear Ratio	3	3.6	6	7.5	9	12.5	15	18	25	30	36	50	60	75	90	100	120	150	180
			r/min	600	500	300	240	200	144	120	100	72	60	50	36	30	24	20	18	15	12
7IDG□-10G	7GBK□BMH	kgfcm	1.7	2.1	3.4	4.3	5.2	7.2	8.6	10.3	12.9	15.5	16.9	23.5	28.2	35.2	42.2	46.9	50.0	50.0	50.0
		N.m	0.17	0.20	0.34	0.42	0.51	0.70	0.84	1.01	1.27	1.52	1.66	2.30	2.76	3.45	4.14	4.60	4.90	4.90	4.90

50Hz

Motor Model	Gearbox Model	Gear Ratio	3	3.6	6	7.5	9	12.5	15	18	25	30	36	50	60	75	90	100	120	150	180
			r/min	500	416	250	200	166	120	100	83	60	50	41	30	25	20	16	15	12.5	10
7IDG□-10G	7GBK□BMH	kgfcm	2.1	2.5	4.2	5.2	6.3	8.7	10.5	12.5	15.8	18.9	20.6	28.6	34.3	42.8	50.0	50.0	50.0	50.0	50.0
		N.m	0.20	0.25	0.41	0.51	0.61	0.85	1.02	1.23	1.54	1.85	2.02	2.80	3.36	4.20	4.90	4.90	4.90	4.90	4.90

- 1) Enter the phase & voltage code in the box (□) within the motor model name.
- 2) Enter the gear ratio in the box (□) within the Gearbox model name.
- 3) A colored background indicates gear shaft rotation in the same direction as the motor shaft; a white background indicates rotation in the opposite direction.
- 4) The rotating speed is calculated by dividing the motor's synchronous speed (50Hz: 1,500r/min, 60Hz: 1,800r/min) by the gear ratio. The actual speed is 2~20% less than the displayed value, depending on the size of the load.

Motor Images

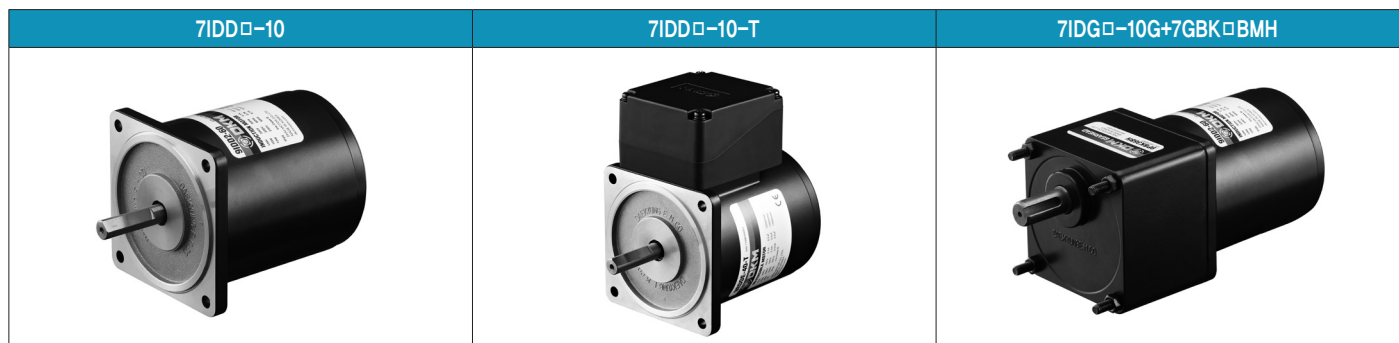

Dimensions

MOTOR ONLY

- MOTOR MODEL: 7IDD□-10(-T) (NO FAN)

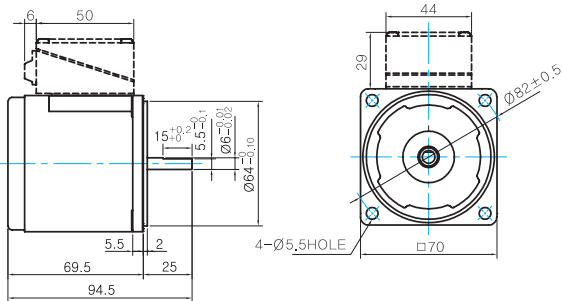

- MOTOR OUTPUT SHAFT

MODEL	SPEC
D-CUT TYPE	

GEARED MOTOR

G TYPE GEARBOX

- MOTOR MODEL: 7IDG□-10G (NO FAN)

- GEARBOX MODEL: 7GBK□BMH

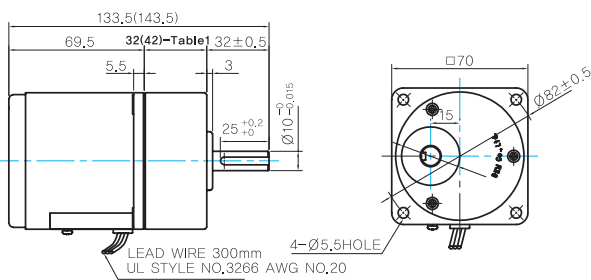

- GEARBOX OUTPUT SHAFT

MODEL	SPEC
KEY TYPE	

- KEY SPEC

GEARBOX	

WEIGHT

PART		WEIGHT(Kg)
MOTOR		0,84
GEAR BOX	7GBK3BMH - 7GBK18BMH	0,36
	7GBK25BMH - 7GBK30BMH	0,44
	7GBK36BMH - 7GBK180BMH	0,5

- 32(42)-Table1

SIZE(mm)	GEAR RATIO
32	7GBK3BMH - 7GBK18BMH
42	7GBK25BMH - 7GBK180BMH

Connection Diagrams

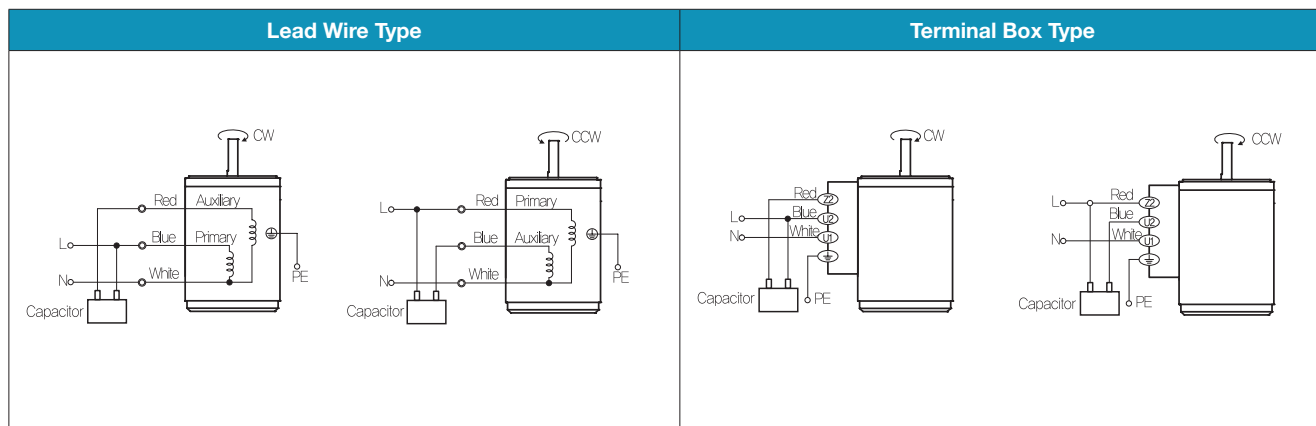

- The direction of motor rotation is as viewed from the shaft end of the motor. 2) CW represents the clockwise direction, while CCW represents the counterclockwise direction.
- Change the direction of single phase motor rotation only after bringing the motor to a stop. If an attempt is made to change the direction of rotation while the motor is rotating, the motor may ignore the reversing command or change its direction after some delay.

B AC Motors

Induction Motor 15W(□70mm)

15W

Induction Motor
15W(□70mm)

Motor Specification

Model		Output W	Voltage V	Frequency Hz	Poles	Duty	Starting Torque		Rated Load			Capacitor μF / VAC	
Lead Wire Type	Terminal Box Type						kgfcm	N.m	Speed r/min	Current A	Torque kgfcm N.m		
7IDG□-15G(-T): Gear Type Shaft 7IDD□-15(-T): D-Cut Type Shaft													
7IDGA-15G	7IDGA-15G-T	15	1∅110	60	4	Cont.	0.77	0.077	1550	0.29	0.99	0.099	3.5 / 250
7IDGD-15G	7IDGD-15G-T	15	1∅220	60	4	Cont.	1.00	0.100	1600	0.18	1.00	0.100	1.2 / 450
7IDGE-15G	7IDGE-15G-T	15	1∅220	50	4	Cont.	0.90	0.090	1200	0.16	1.25	0.125	1.0 / 450
			1∅240				1.10	0.110		0.18	1.40	0.140	

- 1) Enter the phase & voltage code in the box (□) within the motor model name.
- 2) All models contain a built-in thermal protector.
- 3) Gear Type Shaft is for attaching Gearbox and D-Cut Type Shaft is for using motor only.

Max. Permissible Torque at Output Shaft of Gearbox

60Hz

Motor Model	Gearbox Model	Gear Ratio	3	3.6	6	7.5	9	12.5	15	18	25	30	36	50	60	75	90	100	120	150	180	
			r/min	600	500	300	240	200	144	120	100	72	60	50	36	30	24	20	18	15	12	10
7IDG□-15G	7GBK□BMH	kgfcm	2.5	3.0	5.0	6.2	7.5	10.4	12.5	14.9	18.8	22.5	24.5	34.0	40.8	50.0	50.0	50.0	50.0	50.0	50.0	50.0
		N.m	0.24	0.29	0.49	0.61	0.73	1.02	1.22	1.46	1.84	2.21	2.40	3.33	4.00	4.90	4.90	4.90	4.90	4.90	4.90	4.90

50Hz

Motor Model	Gearbox Model	Gear Ratio	3	3.6	6	7.5	9	12.5	15	18	25	30	36	50	60	75	90	100	120	150	180	
			r/min	500	416	250	200	166	120	100	83	60	50	41	30	25	20	16	15	12.5	10	8.3
7IDG□-15G	7GBK□BMH	kgfcm	3.5	4.2	7.0	8.7	10.5	14.5	17.4	20.9	26.3	31.5	34.3	47.6	50.0	50.0	50.0	50.0	50.0	50.0	50.0	50.0
		N.m	0.34	0.41	0.68	0.85	1.02	1.42	1.71	2.05	2.57	3.09	3.36	4.66	4.90	4.90	4.90	4.90	4.90	4.90	4.90	4.90

- 1) Enter the phase & voltage code in the box (□) within the motor model name.
- 2) Enter the gear ratio in the box (□) within the Gearbox model name.
- 3) A colored background indicates gear shaft rotation in the same direction as the motor shaft; a white background indicates rotation in the opposite direction.
- 4) The rotating speed is calculated by dividing the motor's synchronous speed (50Hz: 1,500r/min, 60Hz: 1,800r/min) by the gear ratio. The actual speed is 2~20% less than the displayed value, depending on the size of the load.

Motor Images

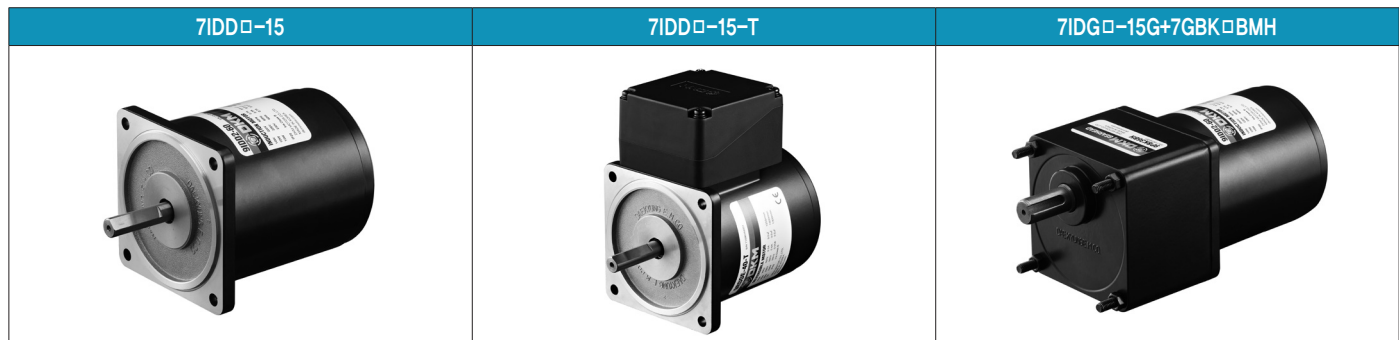

Dimensions

MOTOR ONLY

- MOTOR MODEL: 7IDD□-15(-T) (NO FAN)

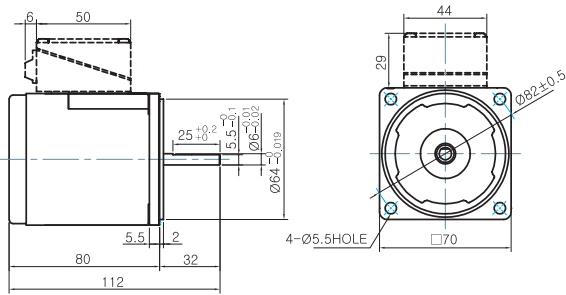

MOTOR OUTPUT SHAFT

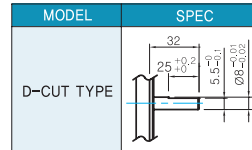

GEARED MOTOR

G TYPE GEARBOX

- MOTOR MODEL: 7IDG□-15G (NO FAN)

- GEARBOX MODEL: 7GBK□BMH

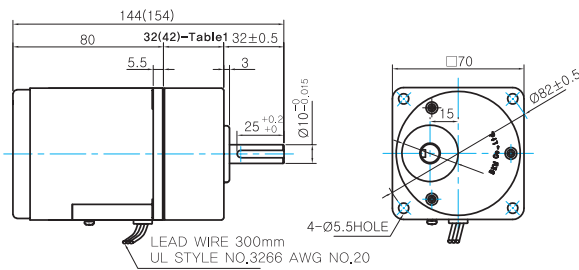

GEARBOX OUTPUT SHAFT

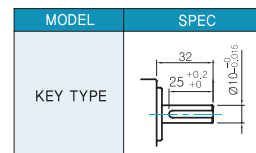

KEY SPEC

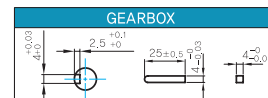

WEIGHT

PART		WEIGHT(Kg)
GEAR BOX	MOTOR	1.04
	7GBK3BMH - 7GBK18BMH	0.36
	7GBK25BMH - 7GBK30BMH	0.44
	7GBK36BMH - 7GBK250BMH	0.5

32(42)-Table1

SIZE(mm)	GEAR RATIO
32	7GBK3BMH - 7GBK18BMH
42	7GBK25BMH - 7GBK180BMH

Connection Diagrams

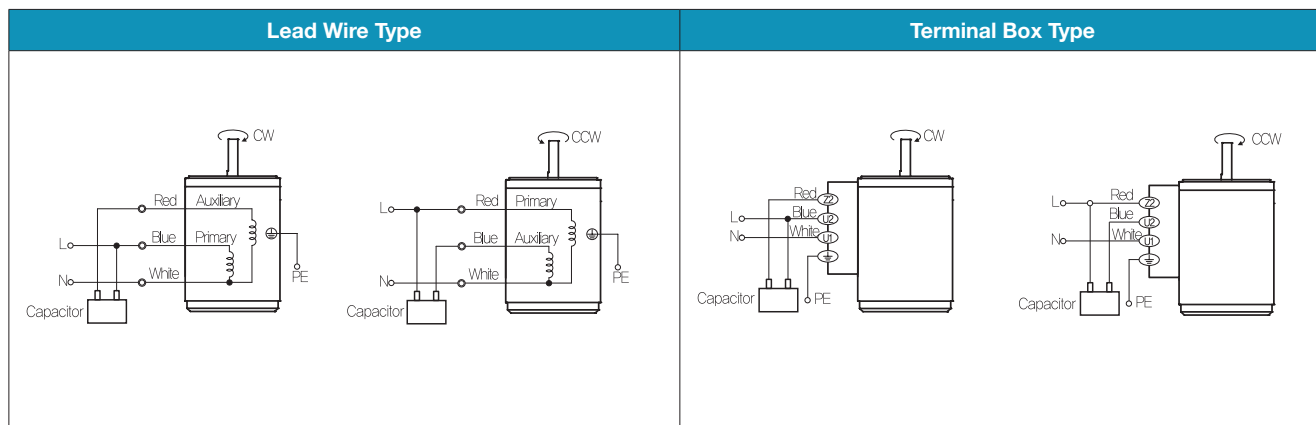

- The direction of motor rotation is as viewed from the shaft end of the motor.
- CW represents the clockwise direction, while CCW represents the counterclockwise direction.
- Change the direction of single phase motor rotation only after bringing the motor to a stop. If an attempt is made to change the direction of rotation while the motor is rotating, the motor may ignore the reversing command or change its direction after some delay.

B AC Motors

Induction Motor 15W(□ 80mm)

15W

Induction Motor
15W(□ 80mm)

Motor Specification

Model		Output W	Voltage V	Frequency Hz	Poles	Duty	Starting Torque		Rated Load			Capacitor μF / VAC	
Lead Wire Type	Terminal Box Type						kgfcm	N.m	Speed r/min	Current A	Torque kgfcm N.m		
8IDG*-15□(-T)	8IDGA-15□-T	15	1∅110	60	4	Cont.	0.84	0.084	1600	0.39	0.98	0.098	3.5 / 450
8IDD*-15(-T)	8IDGD-15□-T	15	1∅220	60	4	Cont.	1.40	0.140	1600	0.22	1.10	0.110	1.2 / 450
8IDGE-15□	8IDGE-15□-T	15	1∅220	50	4	Cont.	1.05	0.105	1250	0.17	1.17	0.117	1.2 / 450
			1∅240				1.20	0.120		0.18	1.30	0.130	
8IDGG-15□	8IDGG-15□-T	15	3∅220	50	4	Cont.	4.80	0.480	1300	0.22	1.40	0.140	-
				60			4.00	0.400	1600	0.18	1.00	0.100	
8IDGK-15□	8IDGK-15□-T	15	3∅380	50	4	Cont.	4.60	0.460	1300	0.13	1.20	0.120	-
				60			3.60	0.360	1550	0.11	1.00	0.100	
			3∅400	50	4	Cont.	5.00	0.500	1300	0.14	1.40	0.140	
				60			4.00	0.400	1600	0.12	1.00	0.100	
			3∅415	50	4	Cont.	5.40	0.540	1350	0.15	1.20	0.120	
				60			4.20	0.420	1600	0.13	1.00	0.100	
			3∅440	50	4	Cont.	6.00	0.600	1350	0.16	1.40	0.140	
				60			4.60	0.460	1600	0.14	1.40	0.140	

- 1) Enter the phase & voltage code in the place * and enter the model type of attaching Gearbox in the box (□) within the motor model name.
- 2) All models contain a built-in thermal protector.
- 3) Gear Type Shaft is for attaching Gearbox and D-Cut Type Shaft is for using motor only.

Max. Permissible Torque at Output Shaft of Gearbox

60Hz

Motor Model	Gearbox Model	Gear Ratio r/min	3	3.6	5	6	7.5	9	12.5	15	18	25	30	36	40	50	60	75	90	100	120	150	180
			8IDG□-15G	8GBK□BMH	kgfcm N.m	3.0 0.29	3.6 0.35	5.0 0.49	6.0 0.59	7.5 0.73	9.0 0.88	12.5 1.22	14.9 1.46	17.9 1.76	22.5 2.21	27.0 2.65	29.4 2.88	32.6 3.20	40.8 4.00	49.0 4.80	61.2 6.00	73.4 7.20	80.0 7.84

Motor Model	Gearbox Model	Gear Ratio r/min	200	250	300	360
			8IDG□-15G	8GBK□BMH	kgfcm N.m	80.0 7.84

Motor Model	Gearbox Model	Gear Ratio r/min	10	12	15	18	25	30	36	50	60
			8IDG□-15W	8WD□BL/□BR/ □BRL	kgfcm N.m	9.8 0.96	11.5 1.13	13.9 1.36	16.0 1.57	21.0 2.06	23.8 2.33

50Hz

Motor Model	Gearbox Model	Gear Ratio r/min	3	3.6	5	6	7.5	9	12.5	15	18	25	30	36	40	50	60	75	90	100	120	150	180
			8IDG□-15G	8GBK□BMH	kgfcm N.m	3.5 0.34	4.2 0.41	5.8 0.57	7.0 0.68	8.7 0.85	10.5 1.02	14.5 1.42	17.4 1.71	20.9 2.05	26.3 2.57	31.5 3.09	34.3 3.36	38.1 3.73	47.6 4.66	57.1 5.60	71.4 7.00	80.0 7.84	80.0 7.84

Motor Model	Gearbox Model	Gear Ratio r/min	200	250	300	360
			8IDG□-15G	8GBK□BMH	kgfcm N.m	80.0 7.84

Motor Model	Gearbox Model	Gear Ratio r/min	10	12	15	18	25	30	36	50	60
			8IDG□-15W	8WD□BL/□BR/ □BRL	kgfcm N.m	11.5 1.13	13.4 1.32	16.2 1.58	18.6 1.83	24.5 2.40	27.7 2.72

- 1) Enter the phase & voltage code in the box (□) within the motor model name.
- 2) Enter the gear ratio in the box (□) within the Gearbox model name.
- 3) A colored background indicates gear shaft rotation in the same direction as the motor shaft; a white background indicates rotation in the opposite direction.
- 4) The rotating speed is calculated by dividing the motor's synchronous speed (50Hz: 1,500r/min, 60Hz: 1,800r/min) by the gear ratio. The actual speed is 2~20% less than the displayed value, depending on the size of the load.

Dimensions

MOTOR ONLY

- MOTOR MODEL: 8IDD□-15(-T) (NO FAN)

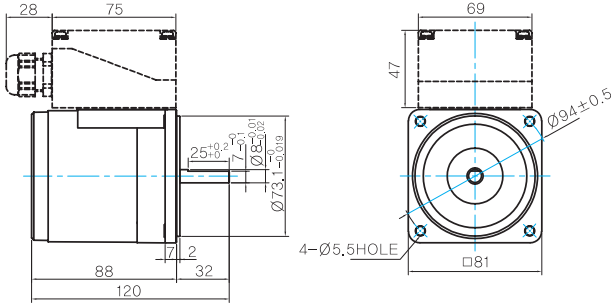

- MOTOR OUTPUT SHAFT

MODEL	SPEC
D-CUT TYPE	

INTER-DECIMAL GEARBOX

- MODEL: 8XD10□□

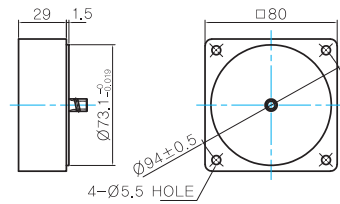

GEARED MOTOR

G TYPE GEARBOX

- MOTOR MODEL: 8IDG□-15G (NO FAN)

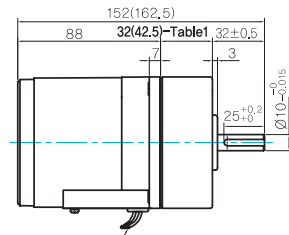

LEAD WIRE 300mm
UL STYLE NO.3271 AWG NO.22

- GEARBOX MODEL: 8GBK□BMH

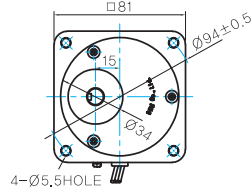

- GEARHEAD OUTPUT SHAFT

MODEL	SPEC
KEY TYPE	

- KEY SPEC

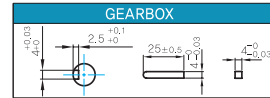

- 32(42.5)-Table1

SIZE(mm)	GEAR RATIO
32	8GBK3BMH - 8GBK18BMH
42.5	8GBK25BMH - 8GBK360BMH

W TYPE GEARBOX

- MOTOR MODEL: 8IDG□-15W (NO FAN)

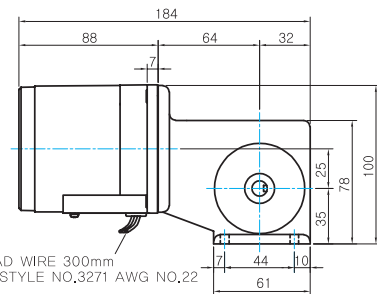

LEAD WIRE 300mm
UL STYLE NO.3271 AWG NO.22

- GEARBOX MODEL: 8WD□BL/BR/BRL

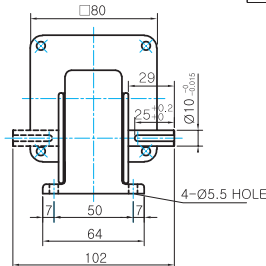

- KEY SPEC

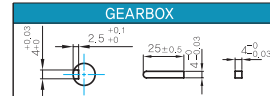

WEIGHT

PART	WEIGHT(Kg)
MOTOR	1.6
8GBK3BMH - 8GBK18BMH	0.48
8GBK25BMH - 8GBK30BMH	0.61
8GBK36BMH - 8GBK180BMH	0.67
8GBK200BMH - 8GBK360BMH	0.63
8WD□BL/BR/BRL	0.67
8XD10□□	0.44

Motor Images

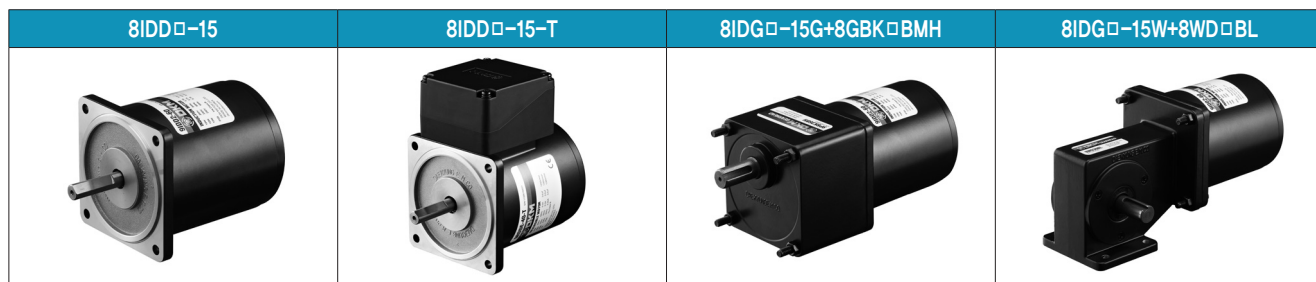

B AC Motors

Induction Motor 15W(□ 80mm)

Connection Diagrams

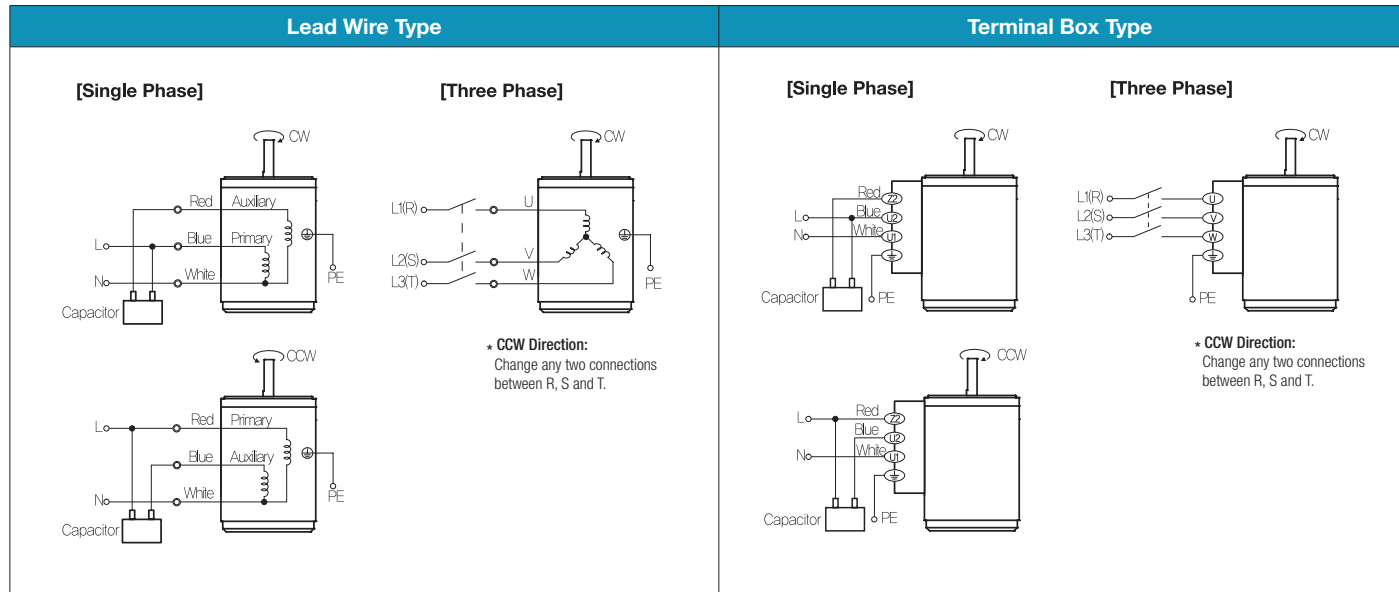

- 1) The direction of motor rotation is as viewed from the shaft end of the motor.
- 2) CW represents the clockwise direction, while CCW represents the counterclockwise direction.
- 3) Change the direction of single phase motor rotation only after bringing the motor to a stop. If an attempt is made to change the direction of rotation while the motor is rotating, the motor may ignore the reversing command or change its direction after some delay.

Induction Motor 25W(□ 80mm)

25W Induction Motor 25W(□ 80mm)

Motor Specification

Model		Output W	Voltage V	Frequency Hz	Poles	Duty	Starting Torque		Rated Load			Capacitor μF / VAC	
81DG ⁺ -25□(-T): Gear Type Shaft	81DD ⁺ -25(-T): D-Cut Type Shaft						kgfcm	N.m	Speed r/min	Current A	Torque		
Lead Wire Type	Terminal Box Type	kgfcm	N.m	kgfcm	N.m								
81DGA-25□	81DGA-25□-T	25	1∅110	60	4	Cont.	1.67	0.167	1550	0.46	1.58	0.158	6.0 / 250
81DGD-25□	81DGD-25□-T	25	1∅220	60	4	Cont.	1.80	0.180	1550	0.25	1.65	0.165	1.5 / 450
81DGE-25□	81DGE-25□-T	25	1∅220	50	4	Cont.	1.10	0.110	1200	0.23	2.10	0.210	1.3 / 450
			1∅240				1.30	0.130					
81DGG-25□	81DGG-25□-T	25	3∅220	50	4	Cont.	5.00	0.500	1300	0.32	2.00	0.200	-
				60			0.40	0.040	1600	0.25	1.60	0.160	
81DGK-25□	81DGK-25□-T	25	3∅380	50	4	Cont.	3.60	0.360	1250	0.14	2.00	0.200	-
				60			3.00	0.300	1500	0.12	1.65	0.165	
			3∅400	50	4	Cont.	3.80	0.380	1250	0.15	2.20	0.220	
				60			3.20	0.320	1500	0.13	1.80	0.180	
			3∅415	50	4	Cont.	4.10	0.410	1300	0.15	2.00	0.200	
				60			3.40	0.340	1550	0.13	1.80	0.180	
			3∅440	50	4	Cont.	4.40	0.440	1300	0.17	2.20	0.220	
				60			3.60	0.360	1600	0.14	1.60	0.160	

1) Enter the phase & voltage code in the place * and enter the model type of attaching Gearbox in the box (□) within the motor model name.

2) All models contain a built-in thermal protector.

3) Gear Type Shaft is for attaching Gearbox and D-Cut Type Shaft is for using motor only.

Max. Permissible Torque at Output Shaft of Gearbox

60Hz

Motor Model	Gearbox Model	Gear Ratio r/min	3	3.6	5	6	7.5	9	12.5	15	18	25	30	36	40	50	60	75	90	100	120	150	180	200
			600	500	360	300	240	200	144	120	100	72	60	50	45	36	30	24	20	18	15	12	10	9
81DG□-25G	8GBK□ BMH	kgfcm	4.5	5.4	7.5	9.0	11.2	13.4	18.7	22.4	26.9	33.8	40.5	44.1	49.0	61.2	73.4	80.0	80.0	80.0	80.0	80.0	80.0	80.0
		N.m	0.44	0.53	0.73	0.88	1.10	1.32	1.83	2.20	2.64	3.31	3.97	4.32	4.80	6.00	7.20	7.84	7.84	7.84	7.84	7.84	7.84	7.84

Motor Model	Gearbox Model	Gear Ratio r/min	200	250	300	360	Motor Model	Gearbox Model	Gear Ratio r/min	10	12	15	18	25	30	36	50	60
			9	7	6	5				81DG□-25W	8WD□BL/□BR/ □BRL	180	150	120	100	72	60	50
81DG□-25G	8GBK□ BMH	kgfcm	80.0	80.0	80.0	80.0	81DG□-25W	8WD□BL/□BR/ □BRL	kgfcm	13.1	15.4	18.5	21.3	28.0	31.7	36.9	48.0	52.8
		N.m	7.84	7.84	7.84	7.84			N.m	1.29	1.51	1.81	2.09	2.74	3.10	3.61	4.70	5.17

50Hz

Motor Model	Gearbox Model	Gear Ratio r/min	3	3.6	5	6	7.5	9	12.5	15	18	25	30	36	40	50	60	75	90	100	120	150	180	200
			500	417	300	250	200	167	120	100	83	60	50	42	38	30	25	20	17	15	13	10	8	7.5
81DG□-25G	8GBK□ BMH	kgfcm	5.5	6.6	9.1	11.0	13.7	16.4	22.8	27.4	32.9	41.3	49.5	53.9	59.8	74.8	80.0	80.0	80.0	80.0	80.0	80.0	80.0	80.0
		N.m	0.54	0.64	0.89	1.07	1.34	1.61	2.24	2.68	3.22	4.04	4.85	5.28	5.86	7.33	7.84	7.84	7.84	7.84	7.84	7.84	7.84	7.84

Motor Model	Gearbox Model	Gear Ratio r/min	200	250	300	360	Motor Model	Gearbox Model	Gear Ratio r/min	10	12	15	18	25	30	36	50	60
			7	6	5	5				81DG□-25W	8WD□BL/□BR/ □BRL	150	125	100	83	60	50	42
81DG□-25G	8GBK□ BMH	kgfcm	80.0	80.0	80.0	80.0	81DG□-25W	8WD□BL/□BR/ □BRL	kgfcm	18.0	21.1	25.4	29.3	38.5	43.6	50.7	66.0	72.6
		N.m	7.84	7.84	7.84	7.84			N.m	1.77	2.07	2.49	2.87	3.77	4.27	4.97	6.47	7.11

1) Enter the phase & voltage code in the box (□) within the motor model name.

2) Enter the gear ratio in the box (□) within the Gearbox model name.

3) A colored background indicates gear shaft rotation in the same direction as the motor shaft; a white background indicates rotation in the opposite direction.

4) The rotating speed is calculated by dividing the motor's synchronous speed (50Hz: 1,500r/min, 60Hz: 1,800r/min) by the gear ratio. The actual speed is 2~20% less than the displayed value, depending on the size of the load.

B AC Motors

Induction Motor 25W(□80mm)

Dimensions

MOTOR ONLY

- MOTOR MODEL: 8IDD□-25(-T) (NO FAN)

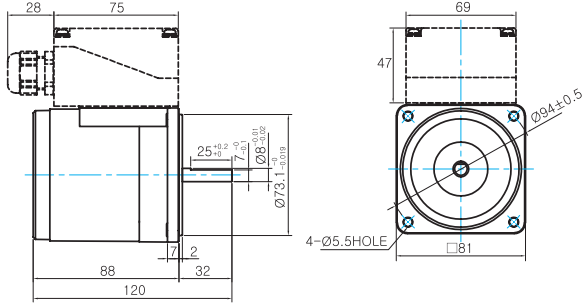

MOTOR OUTPUT SHAFT

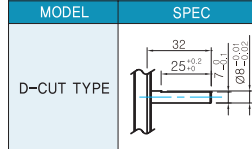

INTER-DECIMAL GEARBOX

- MODEL: 8XD10□□

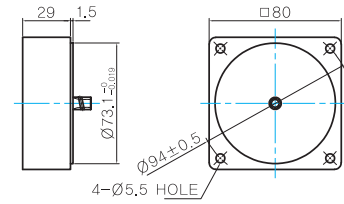

GEARED MOTOR

G TYPE GEARBOX

- MOTOR MODEL: 8IDG□-25G (NO FAN)
- GEARBOX MODEL: 8GBK□BMH

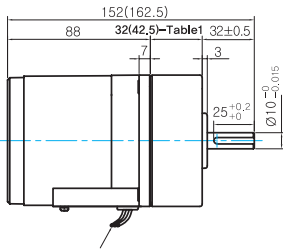

LEAD WIRE 300mm
UL STYLE NO.3271 AWG NO.22

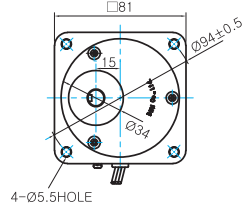

GEARBOX OUTPUT SHAFT

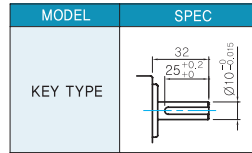

KEY SPEC

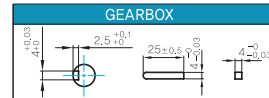

30(40)-Table1

SIZE(mm)	GEAR RATIO
32	8GBK3BMH ~ 8GBK18BMH
42.5	8GBK25BMH ~ 8GBK360BMH

W TYPE GEARBOX

- MOTOR MODEL: 8IDG□-25W (NO FAN)
- GEARBOX MODEL: 8WD□BL/BR/BRL

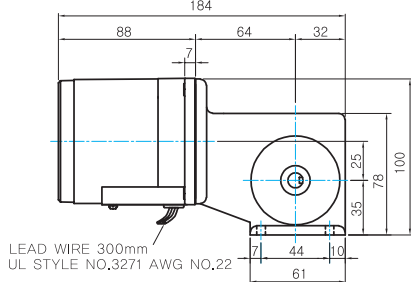

LEAD WIRE 300mm
UL STYLE NO.3271 AWG NO.22

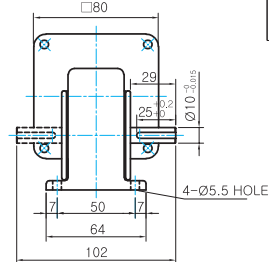

KEY SPEC

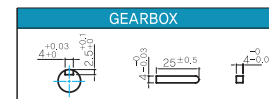

WEIGHT

PART	WEIGHT(Kg)	
MOTOR	1.6	
GEAR BOX	8GBK3BMH ~ 8GBK18BMH	0.48
	8GBK25BMH ~ 8GBK30BMH	0.61
	8GBK36BMH ~ 8GBK180BMH	0.67
	8GBK200BMH ~ 8GBK360BMH	0.63
	8WD□BL/BR/BRL	0.67
	8XD10□□	0.44

Motor Images

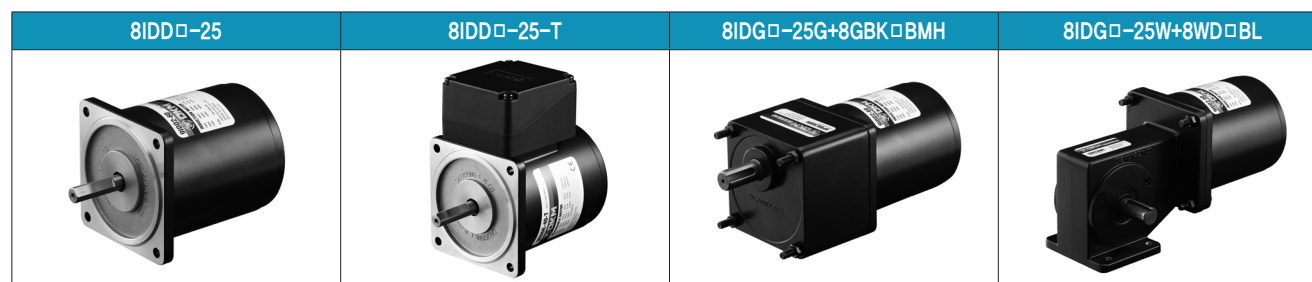

Connection Diagrams

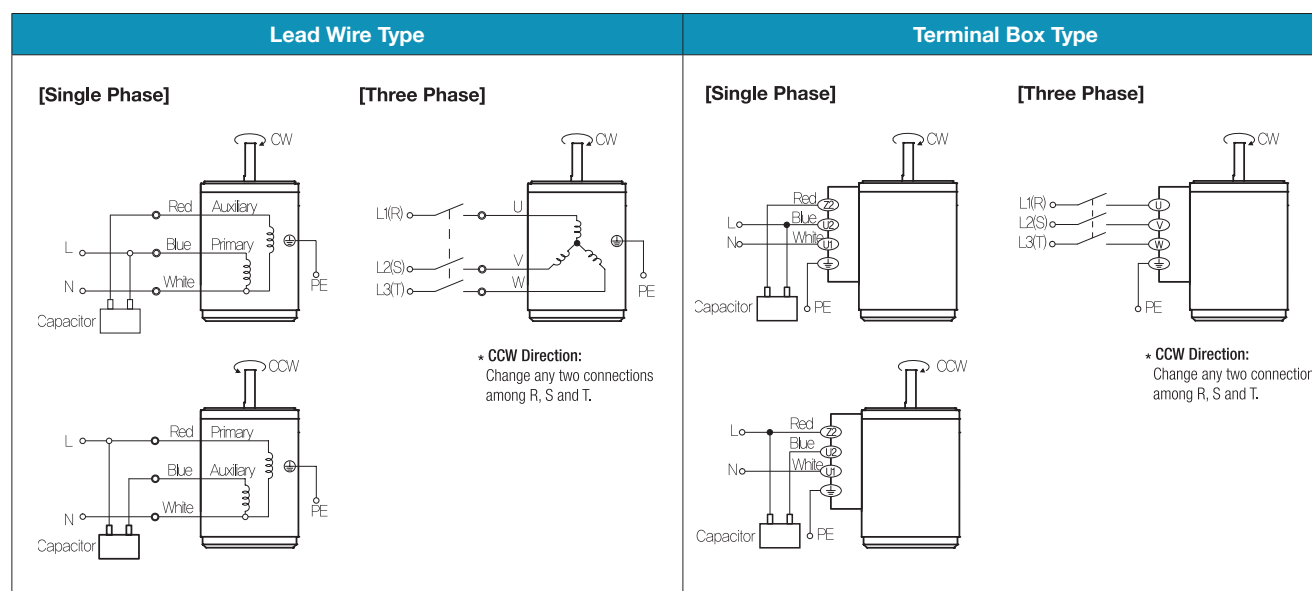

- 1) The direction of motor rotation is as viewed from the shaft end of the motor.
- 2) CW represents the clockwise direction, while CCW represents the counterclockwise direction.
- 3) Change the direction of single phase motor rotation only after bringing the motor to a stop. If an attempt is made to change the direction of rotation while the motor is rotating, the motor may ignore the reversing command or change its direction after some delay.

B AC Motors

Induction Motor 40W(□ 90mm)

40W Induction Motor 40W(□ 90mm)

Motor Specification

Model		Output W	Voltage V	Frequency Hz	Poles	Duty	Starting Torque		Rated Load			Capacitor μF / VAC	
Lead Wire Type	Terminal Box Type						kgfcm	N.m	Speed r/min	Current A	Torque kgfcm N.m		
9IDG* <input type="checkbox"/> -40(-T)	9IDGA-40□-T	40	1∅110	60	4	Cont.	2.60	0.260	1600	0.80	2.80	0.280	10.0 / 250
9IDD* <input type="checkbox"/> -40(-T)	9IDGD-40□-T	40	1∅220	60	4	Cont.	2.60	0.260	1600	0.39	2.80	0.280	2.5 / 450
9IDK* <input type="checkbox"/> -40(-T)	9IDGE-40□-T	40	1∅220	50	4	Cont.	1.80	0.180	1300	0.33	3.00	0.300	2.0 / 450
			1∅240				2.20	0.220		0.36	3.60	0.360	
9IDG□-40	9IDGG-40□-T	40	3∅220	50	4	Cont.	9.00	0.900	1300	0.31	3.20	0.320	-
				60			7.40	0.740	1600	0.27	2.45	0.245	
9IDG□-40	9IDGK-40□-T	40	3∅380	50	4	Cont.	9.00	0.900	1300	0.20	3.20	0.320	-
				60			7.20	0.720	1550	0.18	2.80	0.280	
			3∅400	50	4	Cont.	10.00	1.000	1300	0.20	3.40	0.340	
				60			7.80	0.780	1550	0.18	3.00	0.300	
			3∅415	50	4	Cont.	11.00	1.100	1350	0.20	3.00	0.300	
				60			8.60	0.860	1600	0.18	2.80	0.280	
			3∅440	50	4	Cont.	12.00	1.200	1350	0.21	3.40	0.340	
				60			9.80	0.980	1600	0.19	3.00	0.300	

- 1) Enter the phase & voltage code in the place * and enter the model type of attaching Gearbox in the box (□) within the motor model name.
- 2) All models contain a built-in thermal protector.
- 3) Gear Type Shaft is for attaching Gearbox and D-Cut & Key Type Shafts are for using motor only.

Max. Permissible Torque at Output Shaft of Gearbox

60Hz

Motor Model	Gearbox Model	Gear Ratio r/min	2	3	3.6	5	6	7.5	9	10	12.5	15	18	25	30	36	40	50	60	75	90	100	120	150	180	200
			kgfcm	0.46	7.0	0.68	0.82	1.14	1.37	1.71	2.05	2.28	2.85	3.42	3.70	5.15	6.17	6.72	7.46	9.33	9.80	9.80	9.80	9.80	9.80	9.80
9IDG□-40G	9GBK□ BMH	kgfcm N.m	4.6 0.55	7.0 0.83	8.4 1.00	11.6 1.38	13.9 1.66	17.4 2.07	20.9 2.49	23.2 2.77	29.1 3.46	34.9 4.15	37.8 4.50	52.5 6.25	63.0 7.50	68.5 8.16	76.2 9.06	95.2 9.80	100.0 9.80	100.0 9.80	100.0 9.80	100.0 9.80	100.0 9.80	100.0 9.80	100.0 9.80	100.0 9.80

Motor Model	Gearbox Model	Gear Ratio r/min	10	12	15	18	25	30	36	50	60
			kgfcm	23.0	26.9	32.3	37.3	49.0	55.4	64.5	84.0
9IDG□-40W	9WD□BL/□BR/ □BRL	kgfcm N.m	2.25	2.63	3.17	3.66	4.80	5.43	6.32	8.23	9.06

50Hz

Motor Model	Gearbox Model	Gear Ratio r/min	2	3	3.6	5	6	7.5	9	10	12.5	15	18	25	30	36	40	50	60	75	90	100	120	150	180	200
			kgfcm	5.6	8.5	10.2	14.1	16.9	21.2	25.4	28.2	35.3	42.3	45.9	63.8	76.5	83.2	92.5	100.0	100.0	100.0	100.0	100.0	100.0	100.0	100.0
9IDG□-40G	9GBK□ BMH	kgfcm N.m	0.55	0.83	1.00	1.38	1.66	2.07	2.49	2.77	3.46	4.15	4.50	6.25	7.50	8.16	9.06	9.80	9.80	9.80	9.80	9.80	9.80	9.80	9.80	9.80

Motor Model	Gearbox Model	Gear Ratio r/min	10	12	15	18	25	30	36	50	60
			kgfcm	27.9	32.6	39.3	45.3	59.5	67.3	78.3	102.0
9IDG□-40W	9WD□BL/□BR/ □BRL	kgfcm N.m	2.73	3.20	3.85	4.44	5.83	6.60	7.68	10.00	11.00

- 1) Enter the phase & voltage code in the box (□) within the motor model name.
- 2) Enter the gear ratio in the box (□) within the Gearbox model name.
- 3) A colored background indicates gear shaft rotation in the same direction as the motor shaft; a white background indicates rotation in the opposite direction.
- 4) The rotating speed is calculated by dividing the motor's synchronous speed (50Hz: 1,500r/min, 60Hz: 1,800r/min) by the gear ratio. The actual speed is 2~20% less than the displayed value, depending on the size of the load.

Dimensions

MOTOR ONLY

- MOTOR MODEL: 9IDD□-40(-T) (NO FAN)

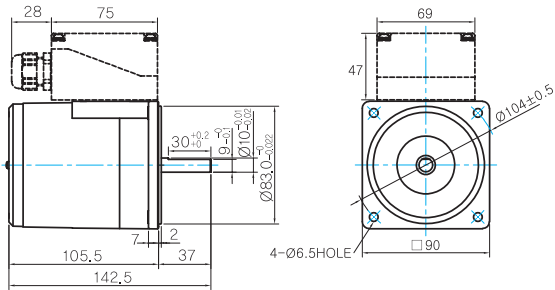

MOTOR OUTPUT SHAFT

MODEL	SPEC
D-CUT TYPE	
9IDD□-40	
KEY TYPE	
9IDK□-40	

INTER-DECIMAL GEARBOX

- MODEL: 9XD10□□

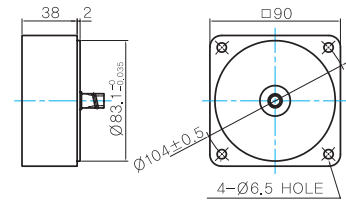

KEY SPEC

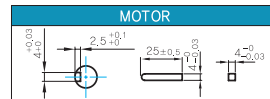

GEARED MOTOR

G TYPE GEARBOX

- MOTOR MODEL: 9IDG□-40G (NO FAN)

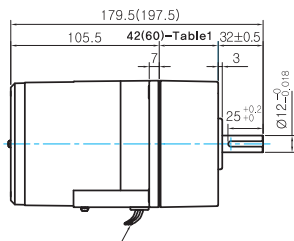

- GEARBOX MODEL: 9GBK□BMH

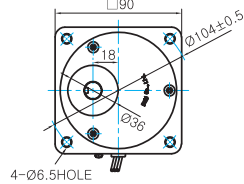

LEAD WIRE 300mm
UL STYLE NO.3271 AWG NO.22

GEARBOX OUTPUT SHAFT

MODEL	SPEC
KEY TYPE	

- 42(60)-Table1

SIZE(mm)	GEAR RATIO
42	9GBK2BMH ~ 9GBK18BMH
60	9GBK25BMH ~ 9GBK200BMH

- Key Spec

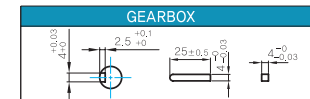

W TYPE GEARBOX

- MOTOR MODEL: 9IDG□-40W (NO FAN)

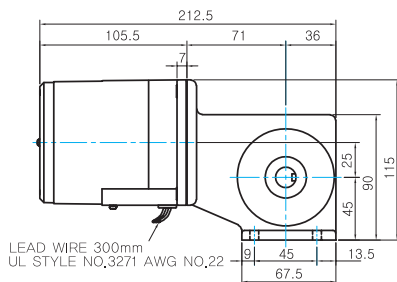

- GEARBOX MODEL: 9WD□BL/BR/BRL

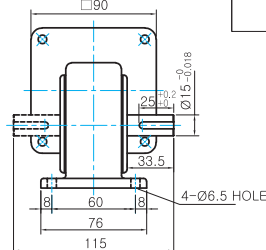

LEAD WIRE 300mm
UL STYLE NO.3271 AWG NO.22

KEY SPEC

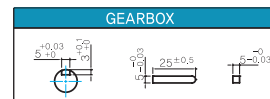

WEIGHT

PART	WEIGHT(Kg)	
MOTOR	2.4	
GEAR BOX	9GBK2BMH ~ 9GBK15BMH	0.67
	9GBK18BMH ~ 9GBK30BMH	0.96
	9GBK36BMH ~ 9GBK200BMH	1.07
	9WD□BL/BR/BRL	1.0
	9XD10□□	0.5

B AC Motors

Induction Motor 40W(□90mm)

Motor Images

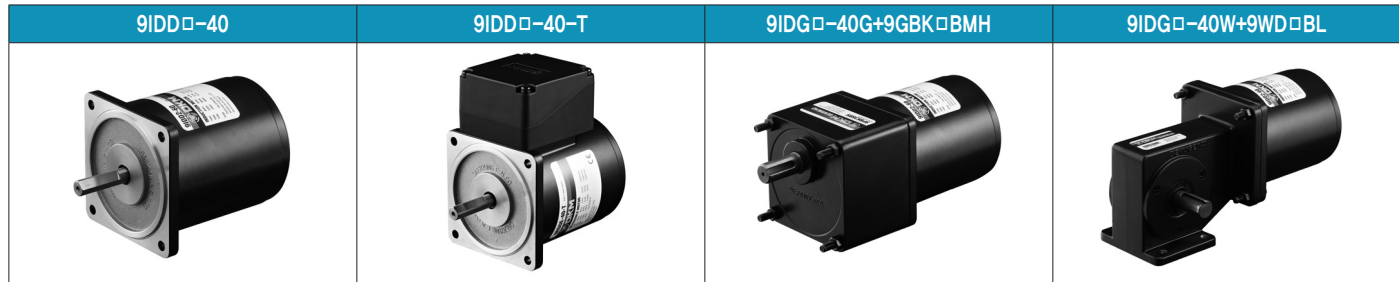

Connection Diagrams

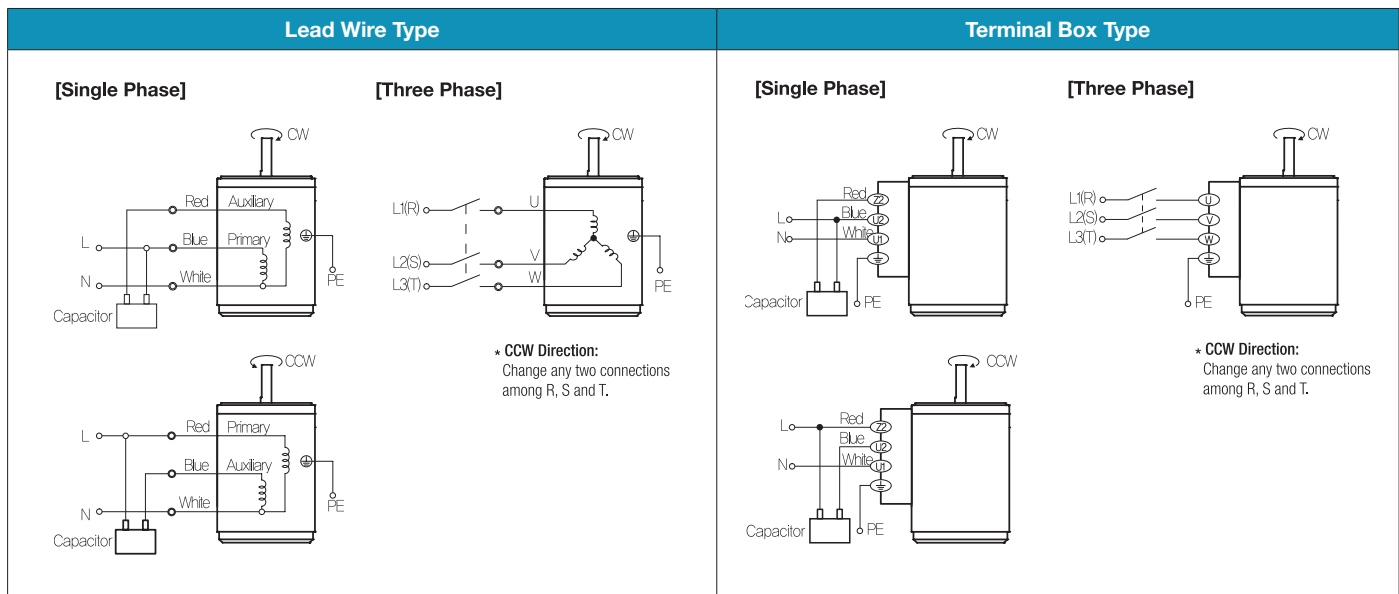

- 1) The direction of motor rotation is as viewed from the shaft end of the motor.
- 2) CW represents the clockwise direction, while CCW represents the counterclockwise direction.
- 3) Change the direction of single phase motor rotation only after bringing the motor to a stop. If an attempt is made to change the direction of rotation while the motor is rotating, the motor may ignore the reversing command or change its direction after some delay.

Induction Motor 60W(□ 90mm)

60W Induction Motor 60W(□ 90mm)

Induction Motor 60W(□ 90mm)

Motor Specification

Model		Output W	Voltage V	Frequency Hz	Poles	Duty	Starting Torque		Rated Load			Capacitor μF / VAC	
Lead Wire Type	Terminal Box Type						kgfcm	N.m	Speed r/min	Current A	Torque kgfcm N.m		
9IDG* <input type="checkbox"/> -60F <input type="checkbox"/> (-T)	9IDGA-60F <input type="checkbox"/> -T	60	1∅110	60	4	Cont.	3.40	0.340	1600	1.40	4.60	0.460	16.0 / 250
9IDD* <input type="checkbox"/> -60F <input type="checkbox"/> (-T)	9IDGD-60F <input type="checkbox"/> -T	60	1∅220	60	4	Cont.	4.20	0.420	1600	0.63	4.60	0.460	4.0 / 450
9IDK* <input type="checkbox"/> -60F <input type="checkbox"/> (-T)	9IDGE-60F <input type="checkbox"/> -T	60	1∅220	50	4	Cont.	3.40	0.340	1300	0.48	4.80	0.480	3.5 / 450
			1∅240				4.00	0.400		0.54	5.40	0.540	
9IDGG-60F <input type="checkbox"/>	9IDGG-60F <input type="checkbox"/> -T	60	3∅220	50	4	Cont.	15.00	1.500	1350	0.59	4.60	0.460	-
				60			12.80	1.280		1600	0.49	4.20	
9IDGK-60F <input type="checkbox"/>	9IDGK-60F <input type="checkbox"/> -T	60	3∅380	50	4	Cont.	17.00	1.700	1350	0.33	4.80	0.480	-
				60			13.80	1.380		1600	0.29	4.60	
			3∅400	50	4	Cont.	18.60	1.860	1350	0.36	5.20	0.520	
				60			15.20	1.520		1600	0.30	5.00	
			3∅415	50	4	Cont.	20.00	2.000	1350	0.40	5.60	0.560	
				60			16.20	1.620		1600	0.33	5.20	
			3∅440	50	4	Cont.	22.00	2.200	1350	0.44	6.00	0.600	
				60			18.20	1.820		1600	0.36	5.80	

- 1) Enter the phase & voltage code in the place * and enter the model type of attaching Gearbox in the box (□) within the motor model name.
- 2) All models contain a built-in thermal protector.
- 3) Gear Type Shaft is for attaching Gearbox and D-Cut & Key Type Shafts are for using motor only.

Max. Permissible Torque at Output Shaft of Gearbox

60Hz

Motor Model	Gearbox Model	Gear Ratio r/min	2	3	3.6	5	6	7.5	9	12.5	15	18	20	25	30	36	40	50	60	75	90	100	120	150	180	200
			900	600	500	360	300	240	200	144	120	100	90	72	60	50	45	36	30	24	20	18	15	12	10	9
9IDG <input type="checkbox"/> -60FP	9PBK <input type="checkbox"/> BH	kgfcm	7.0	10.5	12.5	17.4	20.9	26.1	31.4	39.4	47.3	56.7	57.1	71.4	85.7	102.8	114.2	142.8	171.4	192.2	200.0	200.0	200.0	200.0	200.0	200.0
	9PFK <input type="checkbox"/> BH	N.m	0.68	1.02	1.23	1.71	2.05	2.56	3.07	3.86	4.63	5.56	5.60	7.00	8.40	10.08	11.20	13.99	16.79	18.83	19.60	19.60	19.60	19.60	19.60	19.60
9IDG <input type="checkbox"/> -60FH	9HBK <input type="checkbox"/> BH	kgfcm	-	10.5	12.5	-	20.9	-	31.4	39.4	47.3	56.7	57.1	71.4	85.7	102.8	-	142.8	171.4	192.2	230.6	256.2	300.0	300.0	300.0	300.0
	9HFK <input type="checkbox"/> BH	N.m	-	1.02	1.23	-	2.05	-	3.07	3.86	4.63	5.56	5.60	7.00	8.40	10.08	-	13.99	16.79	18.83	22.60	25.11	29.40	29.40	29.40	29.40

Motor Model	Gearbox Model	Gear Ratio r/min	10	12	15	18	25	30	36	50	60	Motor Model	Gearbox Model	Gear Ratio r/min	7.5	10	15	20	25	30	40	50	60	80
			180	150	120	100	72	60	50	36	30				9IDG <input type="checkbox"/> -60FWH	9WHD <input type="checkbox"/> -030	kgfcm	26.5	34.0	47.9	60.5	69.3	80.6	99.1
9IDG <input type="checkbox"/> -60FW	9WD <input type="checkbox"/> BL/ □BR/□BRL	kgfcm	34.4	40.3	48.5	55.9	73.5	83.2	96.8	126.0	122.4	9IDG <input type="checkbox"/> -60FWH	9WHD <input type="checkbox"/> -030	N.m	2.59	3.33	4.69	5.93	6.79	7.90	9.71	11.11	12.35	13.00
		N.m	3.38	3.95	4.75	5.48	7.20	8.15	9.48	12.35	12.00													

50Hz

Motor Model	Gearbox Model	Gear Ratio r/min	2	3	3.6	5	6	7.5	9	12.5	15	18	20	25	30	36	40	50	60	75	90	100	120	150	180	200
			750	500	417	300	250	200	167	120	100	83	75	60	50	42	38	30	25	20	17	15	13	10	8	7.5
9IDG <input type="checkbox"/> -60FP	9PBK <input type="checkbox"/> BH	kgfcm	8.6	12.9	15.5	21.6	25.9	32.4	38.8	48.8	58.5	70.2	70.7	88.4	106.1	127.3	141.4	176.8	200.0	200.0	200.0	200.0	200.0	200.0	200.0	200.0
	9PFK <input type="checkbox"/> BH	N.m	0.85	1.27	1.52	2.11	2.54	3.17	3.81	4.78	5.73	6.88	6.93	8.66	10.40	12.48	13.86	17.33	19.60	19.60	19.60	19.60	19.60	19.60	19.60	19.60
9IDG <input type="checkbox"/> -60FH	9HBK <input type="checkbox"/> BH	kgfcm	-	12.9	15.5	-	25.9	-	38.8	48.8	58.5	70.2	70.7	88.4	106.1	127.3	-	176.8	212.2	237.9	285.5	300.0	300.0	300.0	300.0	300.0
	9HFK <input type="checkbox"/> BH	N.m	-	1.27	1.52	-	2.54	-	3.81	4.78	5.73	6.88	6.93	8.66	10.40	12.48	-	17.33	20.79	23.31	27.98	29.40	29.40	29.40	29.40	29.40

Motor Model	Gearbox Model	Gear Ratio r/min	10	12	15	18	25	30	36	50	60	Motor Model	Gearbox Model	Gear Ratio r/min	7.5	10	15	20	25	30	40	50	60	80
			150	125	100	83	60	50	42	30	25				9IDG <input type="checkbox"/> -60FWH	9WHD <input type="checkbox"/> -030	kgfcm	32.8	42.1	59.3	74.9	85.8	99.8 <td>122.7</td> <td>140.4</td> <td>156.0</td> <td>132.7</td>	122.7
9IDG <input type="checkbox"/> -60FW	9WD <input type="checkbox"/> BL/ □BR/□BRL	kgfcm	42.6	49.9	60.1	69.3	91.0	103.0	119.8	142.9	122.4	9IDG <input type="checkbox"/> -60FWH	9WHD <input type="checkbox"/> -030	N.m	3.21	4.13	5.81	7.34	8.41	9.78	12.03	13.76	15.29	13.00
		N.m	4.18	4.89	5.89	6.79	8.92	10.09	11.74	14.00	12.00													

- 1) Enter the phase & voltage code in the box (□) within the motor model name.
- 2) Enter the gear ratio in the box (□) within the Gearbox model name.
- 3) A colored background indicates gear shaft rotation in the same direction as the motor shaft; a white background indicates rotation in the opposite direction.
- 4) The rotating speed is calculated by dividing the motor's synchronous speed (50Hz: 1,500r/min, 60Hz: 1,800r/min) by the gear ratio. The actual speed is 2~20% less than the displayed value, depending on the size of the load.

B AC Motors

Induction Motor 60W(□ 90mm)

Dimensions

MOTOR ONLY

- MOTOR MODEL:
9IDD□-60F(-T) (GENERAL FAN)

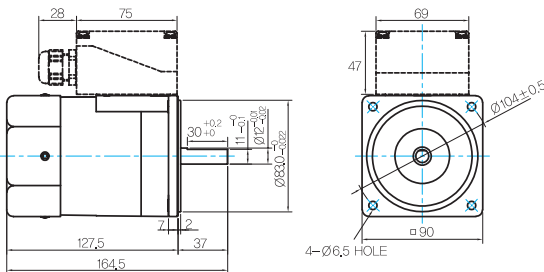

MOTOR OUTPUT SHAFT

MODEL	SPEC
D-CUT TYPE	
KEY TYPE	
9IDD□-60F	
9IDK□-60F	

KEY SPEC

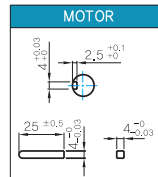

INTER-DECIMAL GEARBOX

- MODEL:
9XD10□□

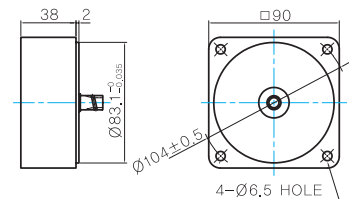

GEARED MOTOR

P TYPE GEARBOX

- MOTOR MODEL:
9IDG□-60FP (GENERAL FAN)

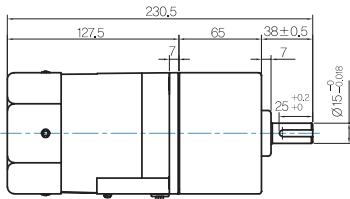

LEAD WIRE 300mm
UL STYLE NO.3271 AWG NO.22

- GEARBOX MODEL:
9PBK□BH

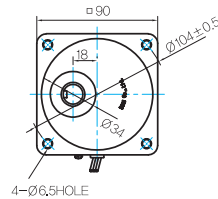

- GEARBOX MODEL:
9PFK□BH

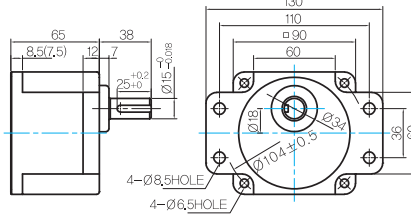

GEARBOX OUTPUT SHAFT

MODEL	SPEC
KEY TYPE	
9PBK□BH	
9PFK□BH	

KEY SPEC

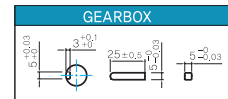

H TYPE GEARBOX

- MOTOR MODEL:
9IDG□-60FH (GENERAL FAN)

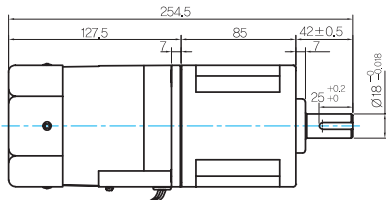

LEAD WIRE 300mm
UL STYLE NO.3271 AWG NO.22

- GEARBOX MODEL:
9HBK□BH

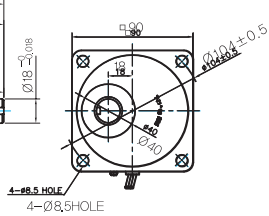

- GEARBOX MODEL:
9HFK□BH

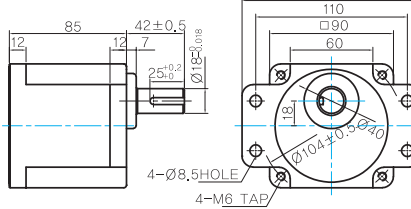

GEARBOX OUTPUT SHAFT

MODEL	SPEC
KEY TYPE	
9HBK□BH	
9HFK□BH	

KEY SPEC

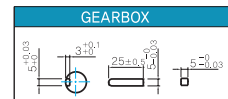

W TYPE GEARBOX

- MOTOR MODEL:
9IDG□-60FW (GENERAL FAN)

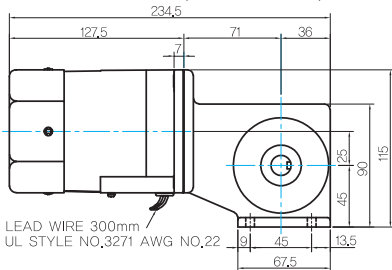

LEAD WIRE 300mm
UL STYLE NO.3271 AWG NO.22

- GEARBOX MODEL:
9WD□BL/BR/BRL

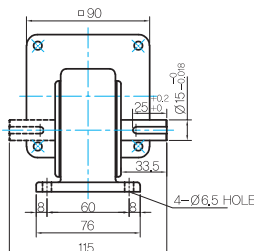

KEY SPEC

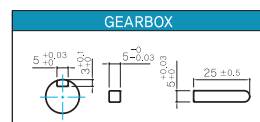

WH TYPE GEARBOX

- MOTOR MODEL:
9IDG□-60FWH (GENERAL FAN)

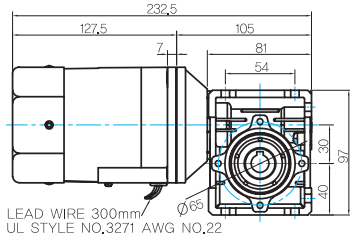

- GEARBOX MODEL:
9WHD□-030

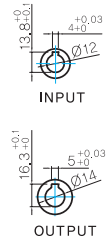
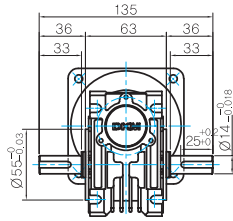

- SHAF

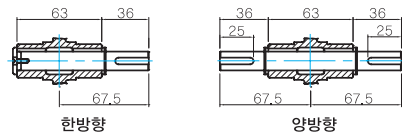

WEIGHT

PART	WEIGHT(Kg)	
MOTOR	3,0	
GEAR BOX	9PB(F)K2BH ~ 9PB(F)K18BH	1,3
	9PB(F)K20BH ~ 9PB(F)K200BH	1,4
	9HB(F)K3BH ~ 9HB(F)K9BH	1,45
	9HB(F)K12.5BH ~ 9HB(F)K18BH	1,5
	9HB(F)K20BH ~ 9HB(F)K60BH	1,7
	9HB(F)K75BH ~ 9HB(F)K200BH	1,8
	9WD□BL/BR/BRL	1,0
9WHD□-030	1,13	
9XD10□□	0,5	

* 출력 FLANGE와 SHAFT는 별매입니다.

- FLANGE

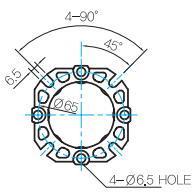

- KEY SPEC

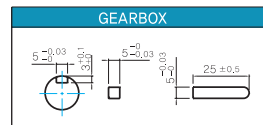

Motor Images

9IDD□-60F	9IDD□-60F-T	9IDG□-60FP+9PB□BH	9IDG□-60FP+9PF□BH
9IDG□-60FH+9HB□BH	9IDG□-60FH+9HF□BH	9IDG□-60FW+9WD□BL	9IDG□-60FWH+9WHD□-030

B AC Motors

Induction Motor 60W(□90mm)

Connection Diagrams

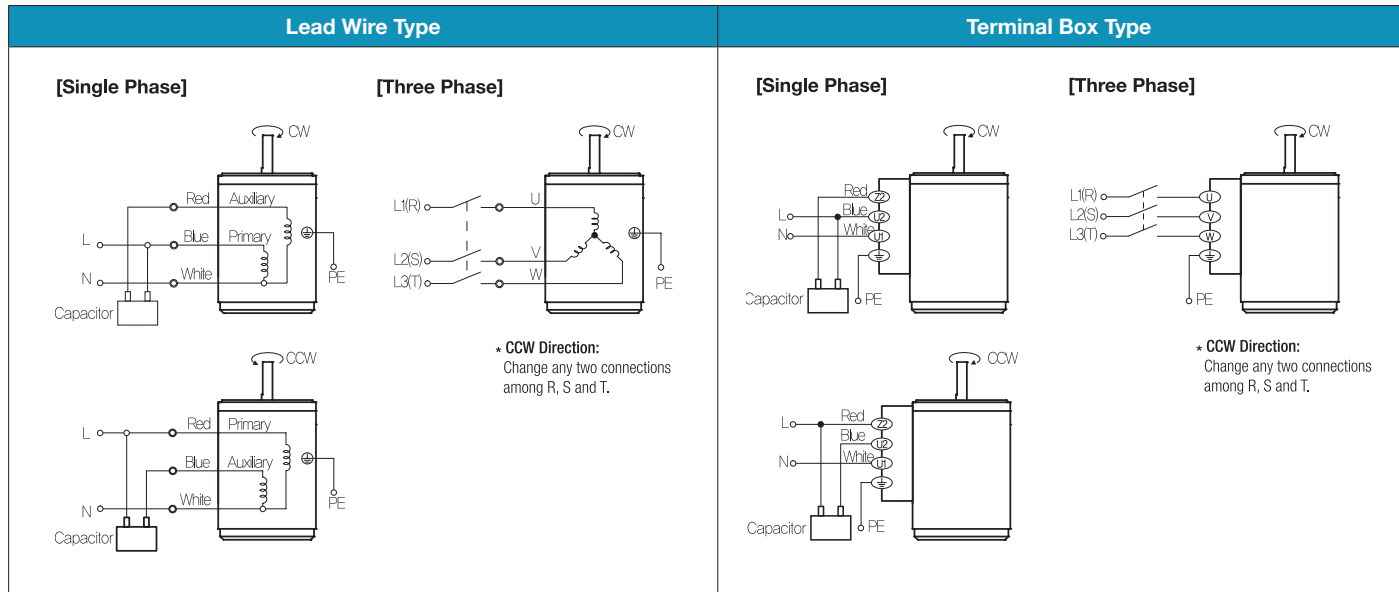

- 1) The direction of motor rotation is as viewed from the shaft end of the motor.
- 2) CW represents the clockwise direction, while CCW represents the counterclockwise direction.
- 3) Change the direction of single phase motor rotation only after bringing the motor to a stop. If an attempt is made to change the direction of rotation while the motor is rotating, the motor may ignore the reversing command or change its direction after some delay.

Induction Motor 90W(□90mm)

90W Induction Motor 90W(□90mm)

Induction Motor 90W(□90mm)

Motor Specification

Model		Output W	Voltage V	Frequency Hz	Poles	Duty	Starting Torque		Rated Load			Capacitor μF / VAC	
Lead Wire Type	Terminal Box Type						kgfcm	N.m	Speed r/min	Current A	Torque kgfcm N.m		
9IDG*~90F□(-T): Gear Type Shaft 9IDD*~90F(-T): D-Cut Type Shaft 9IDK*~90F(-T): Key Type Shaft													
9IDGA-90F□	9IDGA-90F□-T	90	1∅110	60	4	Cont.	5.00	0.500	1600	1.90	6.20	0.620	20.0 / 250
9IDGD-90F□	9IDGD-90F□-T	90	1∅220	60	4	Cont.	5.20	0.520	1600	0.90	6.20	0.620	5.0 / 450
9IDGE-90F□	9IDGE-90F□-T	90	1∅220	50	4	Cont.	5.00	0.500	1300	0.70	7.40	0.740	5.0 / 450
			1∅240				6.00	0.600		0.76	8.60	0.860	
9IDGG-90F□	9IDGG-90F□-T	90	3∅220	50	4	Cont.	20.00	2.000	1300	0.66	7.80	0.780	-
				60			16.60	1.660	1600	0.55	5.80	0.580	
9IDGK-90F□	9IDGK-90F□-T	90	3∅380	50	4	Cont.	21.80	2.180	1300	0.40	7.80	0.780	-
				60			17.20	1.720	1600	0.33	5.80	0.580	
			3∅400	50	4	Cont.	24.00	2.400	1300	0.43	8.60	0.860	
				60			19.20	1.920	1600	0.36	6.20	0.620	
			3∅415	50	4	Cont.	26.00	2.600	1350	0.43	7.40	0.740	
				60			20.20	2.020	1600	0.37	6.80	0.680	
3∅440	50	4	Cont.	29.00	2.900	1350	0.48	8.00	0.800				
	60			23.80	2.380	1650	0.37	6.00	0.600				

- 1) Enter the phase & voltage code in the place * and enter the model type of attaching Gearbox in the box (□) within the motor model name.
- 2) All models contain a built-in thermal protector.
- 3) Gear Type Shaft is for attaching Gearbox and D-Cut & Key Type Shafts are for using motor only.

Max. Permissible Torque at Output Shaft of Gearbox

60Hz

Motor Model	Gearbox Model	Gear Ratio	r/min																							
			900	600	500	360	300	240	200	144	120	100	90	72	60	50	45	36	30	24	20	18	15	12	10	9
9IDG□ -90FP	9PBK□BH 9PFK□BH	kgfcm	10.3	15.4	18.5	25.7	30.9	38.6	46.3	58.1	69.8	83.7	84.3	105.4	126.5	151.8	168.6	200.0	200.0	200.0	200.0	200.0	200.0	200.0	200.0	200.0
		N.m	1.01	1.51	1.82	2.52	3.03	3.78	4.54	5.70	6.84	8.20	8.26	10.33	12.40	14.87	16.53	19.60	19.60	19.60	19.60	19.60	19.60	19.60	19.60	19.60
9IDG□ -90FH	9HBK□BH 9HFK□BH	kgfcm	-	15.4	18.5	-	30.9	-	46.3	58.1	69.8	83.7	84.3	105.4	126.5	151.8	-	210.8	253.0	300.0	300.0	300.0	300.0	300.0	300.0	
		N.m	-	1.51	1.82	-	3.03	-	4.54	5.70	6.84	8.20	8.26	10.33	12.40	14.87	-	20.66	24.79	29.40	29.40	29.40	29.40	29.40	29.40	29.40

Motor Model	Gearbox Model	Gear Ratio	r/min						Motor Model	Gearbox Model	Gear Ratio	r/min												
			10	12	15	18	25	30				7.5	10	15	20	25	30	40	50	60	80			
9IDG□ -90FW	9WD□BL/ □BR/□BRL	kgfcm	50.8	59.5	71.6	82.6	108.5	122.8	153.1	142.9	122.4	9IDG□ -90FWH	9WHD□ -030	kgfcm	39.1	50.2	70.7	89.3	102.3	119.0	146.3	173.5	163.3	132.7
		N.m	4.98	5.83	7.02	8.08	10.63	12.03	15.00	14.00	12.00			N.m	3.83	4.92	6.93	8.75	10.03	11.67	14.34	17.00	16.00	13.00

50Hz

Motor Model	Gearbox Model	Gear Ratio	r/min																						
			750	500	417	300	250	200	167	120	100	83	75	60	50	42	38	30	25	20	17	15	13	10	8
9IDG□ -90FP	9PBK□BH 9PFK□BH	kgfcm	12.3	18.4	22.1	30.7	36.9	46.1	55.3	69.4	83.3	99.9	100.6	125.8	151.0	181.2	200.0	200.0	200.0	200.0	200.0	200.0	200.0	200.0	200.0
		N.m	1.20	1.81	2.17	3.01	3.61	4.51	5.42	6.80	8.16	9.79	9.86	12.33	14.79	17.75	19.60	19.60	19.60	19.60	19.60	19.60	19.60	19.60	19.60
9IDG□ -90FH	9HBK□BH 9HFK□BH	kgfcm	-	18.4	22.1	-	36.9	-	55.3	69.4	83.3	99.9	100.6	125.8	151.0	181.2	-	251.6	300.0	300.0	300.0	300.0	300.0	300.0	300.0
		N.m	-	1.81	2.17	-	3.61	-	5.42	6.80	8.16	9.79	9.86	12.33	14.79	17.75	-	24.66	29.40	29.40	29.40	29.40	29.40	29.40	29.40

Motor Model	Gearbox Model	Gear Ratio	r/min						Motor Model	Gearbox Model	Gear Ratio	r/min												
			10	12	15	18	25	30				7.5	10	15	20	25	30	40	50	60	80			
9IDG□ -90FW	9WD□BL/ □BR/□BRL	kgfcm	60.7	71.0	85.5	98.6	129.5	146.5	153.1	142.9	122.4	9IDG□ -90FWH	9WHD□ -030	kgfcm	46.6	59.9	84.4	106.6	122.1	142.1	174.6	173.5	163.3	132.7
		N.m	5.95	6.96	8.38	9.66	12.69	14.36	15.00	14.00	12.00			N.m	4.57	5.87	8.27	10.44	11.97	13.92	17.11	17.00	16.00	13.00

- 1) Enter the phase & voltage code in the box (□) within the motor model name. 2) Enter the gear ratio in the box (□) within the Gearbox model name.
- 3) A colored background indicates gear shaft rotation in the same direction as the motor shaft; a white background indicates rotation in the opposite direction.
- 4) The rotating speed is calculated by dividing the motor's synchronous speed (50Hz: 1,500r/min, 60Hz: 1,800r/min) by the gear ratio. The actual speed is 2~20% less than the displayed value, depending on the size of the load.

B AC Motors

Induction Motor 90W(□90mm)

Dimensions

MOTOR ONLY

- MOTOR MODEL: 9IDD□-90F(-T) (GENERAL FAN)

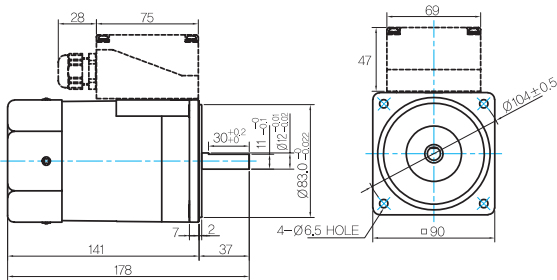

- MOTOR OUTPUT SHAFT

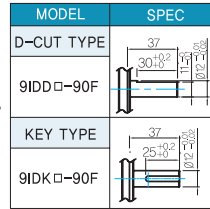

- KEY SPEC

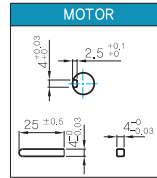

INTER-DECIMAL GEARBOX

- MODEL: 9XD10□□

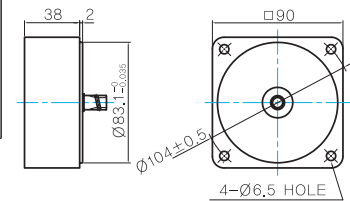

GEARED MOTOR

P TYPE GEARBOX

- MOTOR MODEL: 9IDG□-90FP (GENERAL FAN)
- GEARBOX MODEL: 9PBK□BH
- GEARBOX MODEL: 9PFK□BH

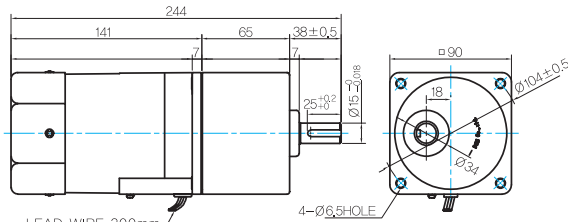

LEAD WIRE 300mm
UL STYLE NO.3271 AWG NO.22

- GEARBOX OUTPUT SHAFT

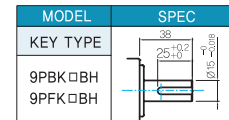

- KEY SPEC

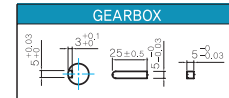

H TYPE GEARBOX

- MOTOR MODEL: 9IDG□-90FH (GENERAL FAN)
- GEARBOX MODEL: 9HBK□BH
- GEARBOX MODEL: 9HFK□BH

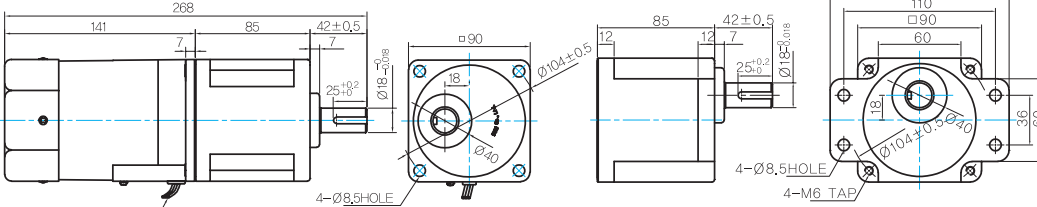

LEAD WIRE 300mm
UL STYLE NO.3271 AWG NO.22

- GEARBOX OUTPUT SHAFT

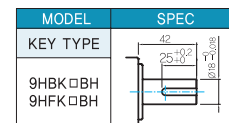

- KEY SPEC

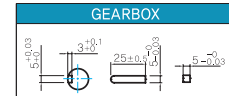

W TYPE GEARBOX

- MOTOR MODEL: 9IDG□-90FW (GENERAL FAN)
- GEARBOX MODEL: 9WD□BL/BR/BRL
- KEY SPEC

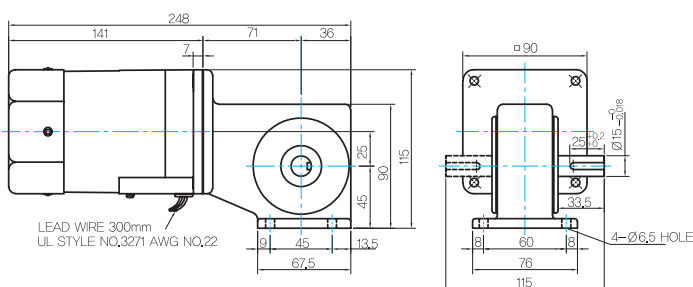

LEAD WIRE 300mm
UL STYLE NO.3271 AWG NO.22

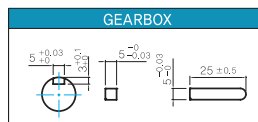

WH TYPE GEARBOX

● MOTOR MODEL:
9IDG□-90FWH (GENERAL FAN)

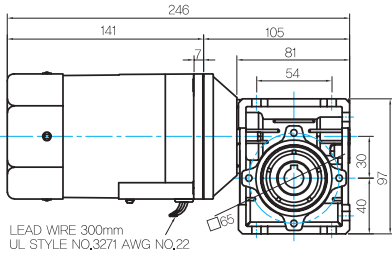

● GEARBOX MODEL:
9WHD□-030

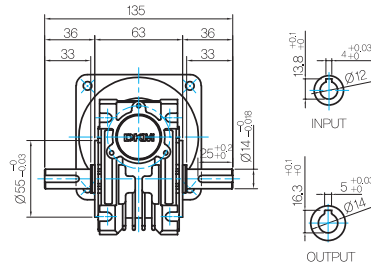

● SHAFT

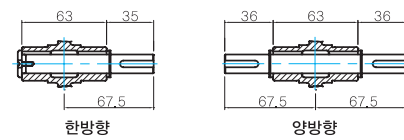

WEIGHT

PART	WEIGHT(kg)	
MOTOR	3,0	
GEAR BOX	9PB(F)K2BH ~ 9PB(F)K18BH	1,3
	9PB(F)K20BH ~ 9PB(F)K200BH	1,4
	9HB(F)K3BH ~ 9HB(F)K9BH	1,45
	9HB(F)K12.5BH ~ 9HB(F)K18BH	1,5
	9HB(F)K20BH ~ 9HB(F)K60BH	1,7
	9HB(F)K75BH ~ 9HB(F)K200BH	1,8
	9WD□BL/BR/BRL	1,0
	9WHD□-030	1,13
9XD10□	0,5	

* 출력 FLANGE와 SHAFT는 별매입니다.

● FLANGE

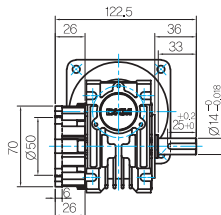
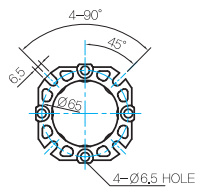

● KEY SPEC

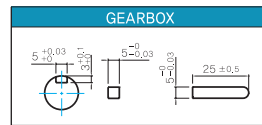

Motor Images

9IDD□-90F	9IDD□-90F-T	9IDG□-90FP+9PBK□BH	9IDG□-90FP+9PFK□BH
9IDG□-90FH+9HBK□BH	9IDG□-90FH+9HFK□BH	9IDG□-90FW+9WD□BL	9IDG□-90FWH+9WHD□-030

B AC Motors

Induction Motor 90W(□90mm)

Connection Diagrams

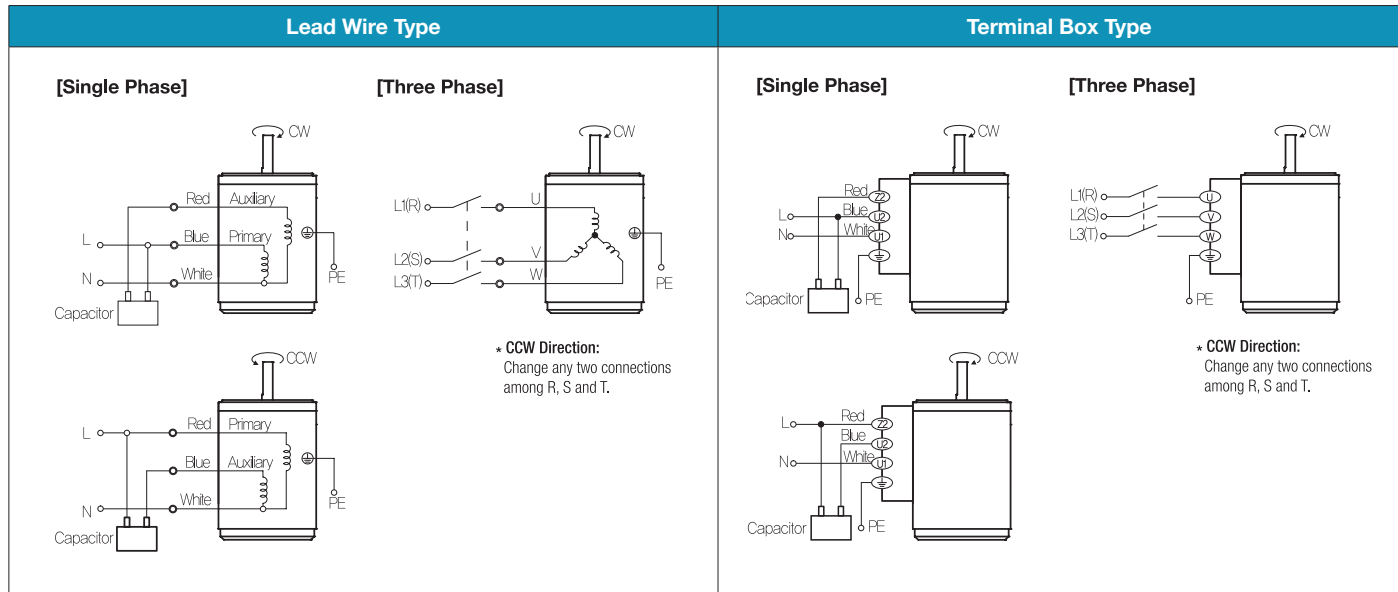

- 1) The direction of motor rotation is as viewed from the shaft end of the motor.
- 2) CW represents the clockwise direction, while CCW represents the counterclockwise direction.
- 3) Change the direction of single phase motor rotation only after bringing the motor to a stop. If an attempt is made to change the direction of rotation while the motor is rotating, the motor may ignore the reversing command or change its direction after some delay.

Induction Motor 120W(□90mm)

120W

Induction Motor
120W(□90mm)

Induction Motor 120W(□90mm)

Motor Specification

Model		Output W	Voltage V	Frequency Hz	Poles	Duty	Starting Torque		Rated Load			Capacitor μF / VAC	
Lead Wire Type	Terminal Box Type						kgfcm	N.m	Speed r/min	Current A	Torque kgfcm N.m		
9IDG*-120F□(-T): Gear Type Shaft 9IDD*-120F(-T): D-Cut Type Shaft 9IDK*-120F(-T): Key Type Shaft													
9IDGA-120F□	9IDGA-120F□-T	120	1∅110	60	4	Cont.	6.60	0.660	1600	2.00	7.40	0.740	25.0 / 250
9IDGD-120F□	9IDGD-120F□-T	120	1∅220	60	4	Cont.	6.00	0.600	1600	1.00	7.60	0.760	6.0 / 450
9IDGE-120F□	9IDGE-120F□-T	120	1∅220	50	4	Cont.	6.60	0.660	1250	0.90	9.40	0.940	6.5 / 450
			1∅240				8.00	0.800		1.00	10.20	1.020	
9IDGG-120F□	9IDGG-120F□-T	120	3∅220	50	4	Cont.	22.00	2.200	1300	0.82	9.20	0.920	-
				60			20.00	2.000		1550	0.78	7.80	
9IDGK-120F□	9IDGK-120F□-T	120	3∅380	50	4	Cont.	25.00	2.500	1300	0.48	9.00	0.900	-
				60			20.00	2.000		1550	0.43	8.00	
			3∅400	50	4	Cont.	27.40	2.740	1300	0.53	9.80	0.980	
				60			21.80	2.180		1550	0.45	8.60	
			3∅415	50	4	Cont.	29.80	2.980	1300	0.57	10.00	1.000	
				60			23.80	2.380		1600	0.44	7.80	
			3∅440	50	4	Cont.	32.00	3.200	1350	0.64	8.80	0.880	
				60			26.80	2.680		1600	0.48	8.60	

- 1) Enter the phase & voltage code in the place * and enter the model type of attaching Gearbox in the box (□) within the motor model name.
- 2) All models contain a built-in thermal protector.
- 3) Gear Type Shaft is for attaching Gearbox and D-Cut & Key Type Shafts are for using motor only.

Max. Permissible Torque at Output Shaft of Gearbox

60Hz

Motor Model	Gearbox Model	Gear Ratio r/min	2	3	3.6	5	6	7.5	9	12.5	15	18	20	25	30	36	40	50	60	75	90	100	120	150	180	200
			900	600	500	360	300	240	200	144	120	100	90	72	60	50	45	36	30	24	20	18	15	12	10	9
9IDG□ -120FP	9PBK□BH	kgfcm	12.6	18.9	22.7	31.5	37.8	47.3	56.8	71.3	85.5	102.6	103.4	129.2	155.0	186.0	200.0	200.0	200.0	200.0	200.0	200.0	200.0	200.0	200.0	200.0
	9PFK□BH	N.m	1.24	1.85	2.23	3.09	3.71	4.64	5.56	6.98	8.38	10.05	10.13	12.66	15.19	18.23	19.60	19.60	19.60	19.60	19.60	19.60	19.60	19.60	19.60	19.60
9IDG□ -120FH	9HBK□BH	kgfcm	18.9	22.7	-	37.8	-	56.8	71.3	85.5	102.6	103.4	129.2	155.0	186.0	-	258.4	300.0	300.0	300.0	300.0	300.0	300.0	300.0	300.0	300.0
	9HFK□BH	N.m	-	1.85	2.23	-	3.71	-	5.56	6.98	8.38	10.05	10.13	12.66	15.19	18.23	-	25.32	29.40	29.40	29.40	29.40	29.40	29.40	29.40	29.40

Motor Model	Gearbox Model	Gear Ratio r/min	10	12	15	18	25	30	36	50	60	Motor Model	Gearbox Model	Gear Ratio r/min	7.5	10	15	20	25	30	40	50	60	80
			180	150	120	100	72	60	50	36	30				9IDG□ -120FWH	9WHD□ -030	kgfcm	240	180	120	90	72	60	45
9IDG□ -120FW	9WD□BL/ □BR/□BRL	kgfcm	62.3	73.0	87.8	101.2	133.0	150.5	153.1	142.9	122.4	9IDG□ -120FWH	9WHD□ -030	kgfcm	47.9	61.6	86.6	109.4	125.4	145.9	179.4	173.5	163.3	132.7
	N.m	6.11	7.15	8.60	9.92	13.03	14.75	15.00	14.00	12.00	N.m				4.69	6.03	8.49	10.73	12.29	14.30	17.58	17.00	16.00	13.00

50Hz

Motor Model	Gearbox Model	Gear Ratio r/min	2	3	3.6	5	6	7.5	9	12.5	15	18	20	25	30	36	40	50	60	75	90	100	120	150	180	200
			750	500	417	300	250	200	167	120	100	83	75	60	50	42	38	30	25	20	17	15	13	10	8	7.5
9IDG□ -120FP	9PBK□BH	kgfcm	16.3	24.4	29.3	40.7	48.8	61.0	73.2	101.7	122.0	146.4	162.7	200.0	200.0	200.0	200.0	200.0	200.0	200.0	200.0	200.0	200.0	200.0	200.0	200.0
	9PFK□BH	N.m	1.59	2.39	2.87	3.99	4.78	5.98	7.17	9.96	11.96	14.35	15.94	19.60	19.60	19.60	19.60	19.60	19.60	19.60	19.60	19.60	19.60	19.60	19.60	19.60
9IDG□ -120FH	9HBK□BH	kgfcm	24.4	29.3	-	48.8	-	73.2	91.9	110.3	132.3	133.3	166.6	199.9	239.9	-	300.0	300.0	300.0	300.0	300.0	300.0	300.0	300.0	300.0	300.0
	9HFK□BH	N.m	2.39	2.87	-	4.78	-	7.17	9.00	10.80	12.97	13.06	16.33	19.59	23.51	-	29.40	29.40	29.40	29.40	29.40	29.40	29.40	29.40	29.40	29.40

Motor Model	Gearbox Model	Gear Ratio r/min	10	12	15	18	25	30	36	50	60	Motor Model	Gearbox Model	Gear Ratio r/min	7.5	10	15	20	25	30	40	50	60	80
			150	125	100	83	60	50	42	30	25				9IDG□ -120FWH	9WHD□ -030	kgfcm	200	150	100	75	60	50	38
9IDG□ -90FW	9WD□BL/ □BR/□BRL	kgfcm	80.4	94.1	113.2	130.5	142.9	163.3	153.1	142.9	122.4	9IDG□ -120FWH	9WHD□ -030	kgfcm	61.7	79.4	111.7	141.1	161.7	188.2	183.7	173.5	163.3	132.7
	N.m	7.88	9.22	11.09	12.79	14.00	16.00	15.00	14.00	12.00	N.m				6.05	7.78	10.95	13.83	15.85	18.44	18.00	17.00	16.00	13.00

- 1) Enter the phase & voltage code in the box (□) within the motor model name.
- 2) Enter the gear ratio in the box (□) within the Gearbox model name.
- 3) A colored background indicates gear shaft rotation in the same direction as the motor shaft; a white background indicates rotation in the opposite direction.
- 4) The rotating speed is calculated by dividing the motor's synchronous speed (50Hz: 1,500r/min, 60Hz: 1,800r/min) by the gear ratio. The actual speed is 2~20% less than the displayed value, depending on the size of the load.

B AC Motors

Induction Motor 120W(□90mm)

Dimensions

MOTOR ONLY

- MOTOR MODEL:
9IDD□-120F(-T) (GENERAL FAN)

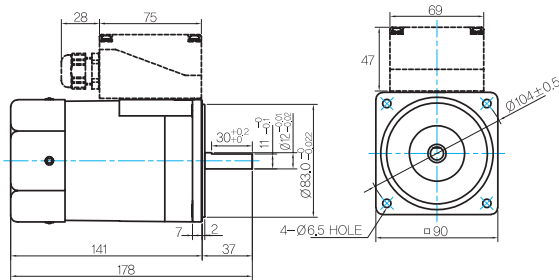

- MOTOR OUTPUT SHAFT

MODEL	SPEC
D-CUT TYPE	
KEY TYPE	
9IDD□-120F	
9IDK□-120F	

- KEY SPEC

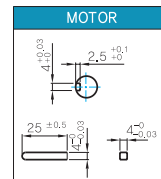

INTER-DECIMAL GEARBOX

- MODEL:
9XD10□□

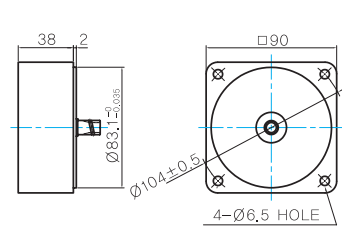

GEARED MOTOR

P TYPE GEARBOX

- MOTOR MODEL:
9IDG□-120FP (GENERAL FAN)

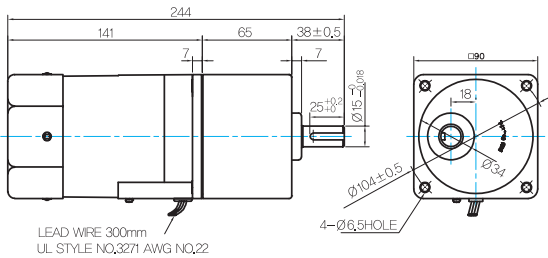

LEAD WIRE 300mm
UL STYLE NO.3271 AWG NO.22

- GEARBOX MODEL:
9PBK□BH

- GEARBOX MODEL:
9PFK□BH

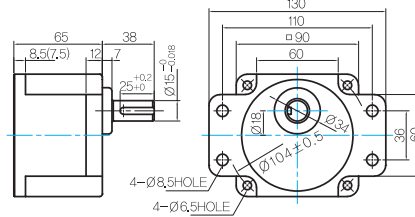

- GEARBOX OUTPUT SHAFT

MODEL	SPEC
KEY TYPE	
9PBK□BH	
9PFK□BH	

- KEY SPEC

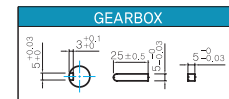

H TYPE GEARBOX

- MOTOR MODEL:
9IDG□-120FH (GENERAL FAN)

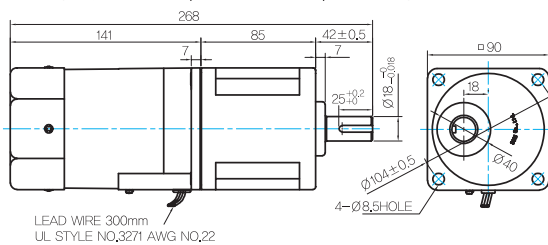

LEAD WIRE 300mm
UL STYLE NO.3271 AWG NO.22

- GEARBOX MODEL:
9HBK□BH

- GEARBOX MODEL:
9HFK□BH

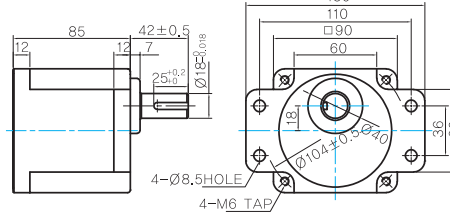

- GEARBOX OUTPUT SHAFT

MODEL	SPEC
KEY TYPE	
9HBK□BH	
9HFK□BH	

- KEY SPEC

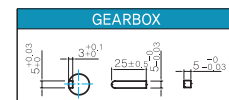

W TYPE GEARBOX

- MOTOR MODEL:
9IDG□-120FW (GENERAL FAN)

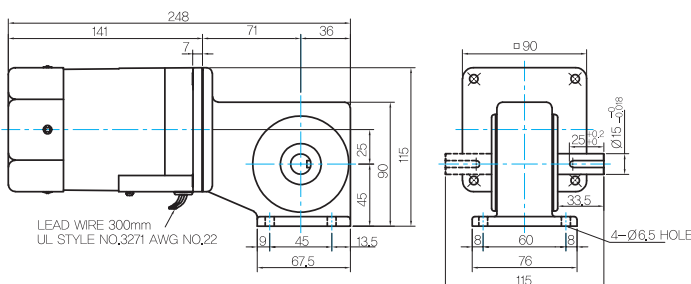

LEAD WIRE 300mm
UL STYLE NO.3271 AWG NO.22

- GEARBOX MODEL:
9WD□BL/BR/BRL

- KEY SPEC

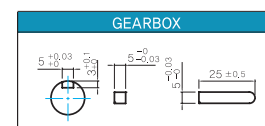

WH TYPE GEARBOX

● MOTOR MODEL:
9IDG□-120FWH (GENERAL FAN)

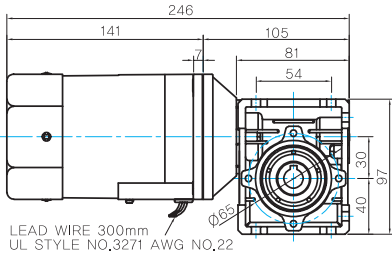

● GEARBOX MODEL:
9WHD□-030

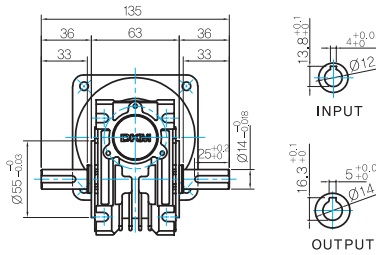

● SHAFT

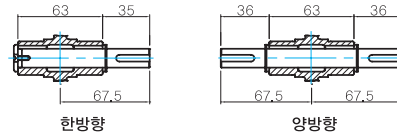

한방향

양방향

WEIGHT

PART	WEIGHT(Kg)	
MOTOR	3.0	
GEAR BOX	9PB(F)K2BH ~ 9PB(F)K18BH	1.3
	9PB(F)K20BH ~ 9PB(F)K200BH	1.4
	9HB(F)K3BH ~ 9HB(F)K9BH	1.45
	9HB(F)K12.5BH ~ 9HB(F)K18BH	1.5
	9HB(F)K20BH ~ 9HB(F)K60BH	1.7
	9HB(F)K75BH ~ 9HB(F)K200BH	1.8
9WD□BL/BR/BRL	1.0	
9WHD□-030	1.13	
9XD10□□	0.5	

* 출력 FLANGE와 SHAFT는 별매입니다.

● FLANGE

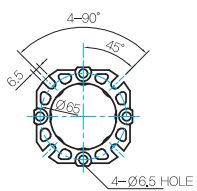

● KEY SPEC

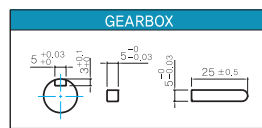

Motor Images

9IDD□-120F	9IDD□-120F-T	9IDG□-120FP+9PBK□BH	9IDG□-120FP+9PFK□BH
9IDG□-120FH+9HBK□BH	9IDG□-120FH+9HFK□BH	9IDG□-120FW+9WD□BL	9IDG□-120FWH+9WHD□-030

B AC Motors

Induction Motor 120W(□90mm)

Connection Diagrams

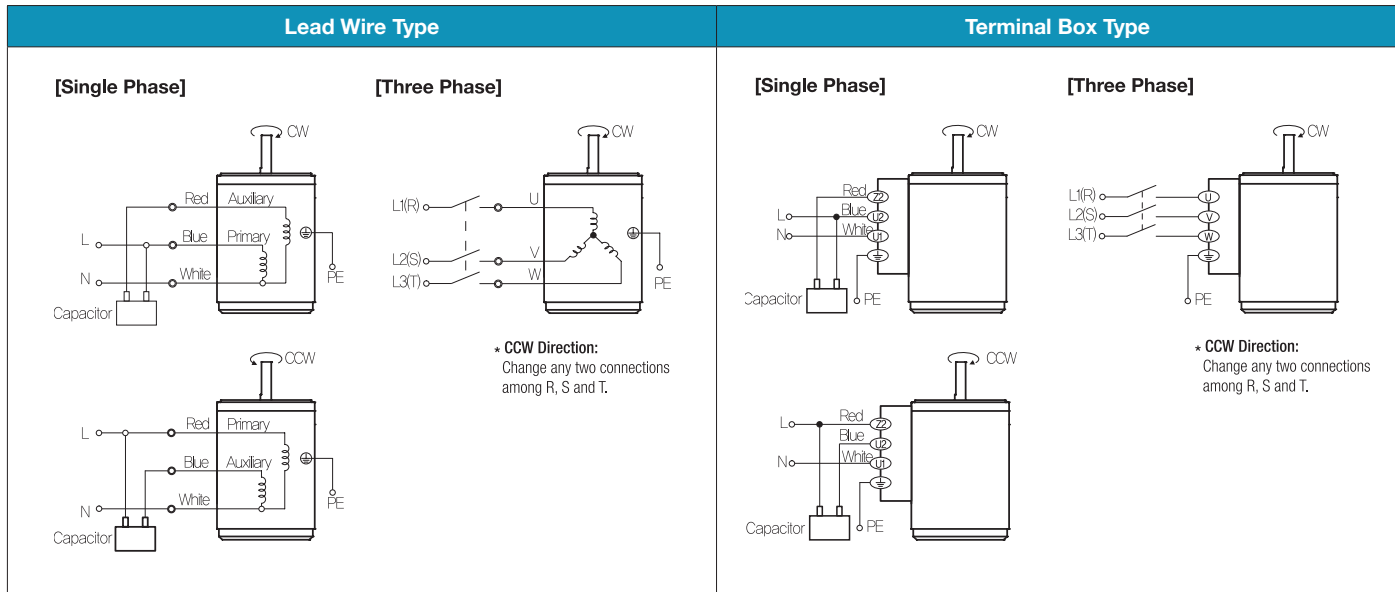

- 1) The direction of motor rotation is as viewed from the shaft end of the motor.
- 2) CW represents the clockwise direction, while CCW represents the counterclockwise direction.
- 3) Change the direction of single phase motor rotation only after bringing the motor to a stop. If an attempt is made to change the direction of rotation while the motor is rotating, the motor may ignore the reversing command or change its direction after some delay.

Induction Motor 150W(□90mm)

150W

Induction Motor
150W(□90mm)

Motor Specification

Model		Output W	Voltage V	Frequency Hz	Poles	Duty	Starting Torque		Rated Load			Capacitor μF / VAC	
Lead Wire Type	Terminal Box Type						kgfcm	N.m	Speed r/min	Current A	Torque kgfcm N.m		
9IDGG-150F□	9IDGG-150F□-T	150	3∅220	50	4	Cont.	22.00	2.200	1300	1.00	11.30	1.130	-
				60			19.00	1.900	1550	0.90	9.40	0.940	
9IDGK-150F□	9IDGK-150F□-T	150	3∅380	50	4	Cont.	18.00	1.800	1250	0.46	11.70	1.170	-
				60			15.00	1.500	1500	0.42	9.70	0.970	
			3∅400	50	4	Cont.	19.00	1.900	1250	0.49	11.70	1.170	
				60			16.00	1.600	1500	0.43	9.70	0.970	

- 1) Enter the phase & voltage code in the place * and enter the model type of attaching Gearbox in the box (□) within the motor model name.
- 2) All models contain a built-in thermal protector.
- 3) Gear Type Shaft is for attaching Gearbox and D-Cut & Key Type Shafts are for using motor only.

Max. Permissible Torque at Output Shaft of Gearbox

60Hz

Motor Model	Gearbox Model	Gear Ratio	3	3.6	6	9	12.5	15	18	20	25	30	36	50	60	75	90	100	120	150	180	200
			r/min	600	500	300	200	144	120	100	90	72	60	50	36	30	24	20	18	15	12	10
9IDG□ -150FH	9HBK□BH 9HFK□BH	kgfcm	24.2	29.0	48.3	72.5	90.9	109.1	131.0	131.9	164.9	197.9	237.5	300.0	300.0	300.0	300.0	300.0	300.0	300.0	300.0	300.0
		N.m	2.37	2.84	4.73	7.10	8.91	10.69	12.83	12.93	16.16	19.39	23.27	29.40	29.40	29.40	29.40	29.40	29.40	29.40	29.40	29.40

Motor Model	Gearbox Model	Gear Ratio	7.5	10	15	20	25	30	40	50	60	80	100
			r/min	240	180	120	90	72	60	45	36	30	22.5
9IDG□-150FWH	9WHD□-030	kgfcm	61.1	78.6	110.6	139.7	160.1	186.2	183.7	173.5	163.3	132.7	-
		N.m	5.99	7.70	10.84	13.69	15.68	18.25	18.00	17.00	16.00	13.00	-
	9WHD□-040	kgfcm	-	-	-	-	-	-	-	230.0	255.0	295.0	270.0
		N.m	-	-	-	-	-	-	-	22.55	25.00	28.92	26.47

50Hz

Motor Model	Gearbox Model	Gear Ratio	3	3.6	6	9	12.5	15	18	20	25	30	36	50	60	75	90	100	120	150	180	200
			r/min	500	417	250	167	120	100	83	75	60	50	42	30	25	20	17	15	13	10	8
9IDG□ -150FH	9HBK□BH 9HFK□BH	kgfcm	28.1	33.8	56.3	84.4	105.9	127.1	152.6	153.7	192.1	230.5	276.6	300.0	300.0	300.0	300.0	300.0	300.0	300.0	300.0	300.0
		N.m	2.76	3.31	5.51	8.27	10.38	12.46	14.95	15.06	18.83	22.59	27.11	29.40	29.40	29.40	29.40	29.40	29.40	29.40	29.40	29.40

Motor Model	Gearbox Model	Gear Ratio	7.5	10	15	20	25	30	40	50	60	80	100
			r/min	200	150	100	75	60	50	37.5	30	25	18.75
9IDG□-150FWH	9WHD□-030	kgfcm	71.2	91.5	128.8	162.7	186.5	204.1	183.7	173.5	163.3	132.7	-
		N.m	6.98	8.97	12.62	15.95	18.28	20.00	18.00	17.00	16.00	13.00	-
	9WHD□-040	kgfcm	-	-	-	-	-	-	-	275.0	305.0	295.0	270.0
		N.m	-	-	-	-	-	-	-	26.96	29.90	28.92	26.47

- 1) Enter the phase & voltage code in the box (□) within the motor model name.
- 2) Enter the gear ratio in the box (□) within the Gearbox model name.
- 3) A colored background indicates gear shaft rotation in the same direction as the motor shaft; a white background indicates rotation in the opposite direction.
- 4) The rotating speed is calculated by dividing the motor's synchronous speed (50Hz: 1,500r/min, 60Hz: 1,800r/min) by the gear ratio. The actual speed is 2~20% less than the displayed value, depending on the size of the load.

B AC Motors

Induction Motor 150W(□90mm)

Dimensions

MOTOR ONLY

- MOTOR MODEL:
9IDD□-150F(-T) (GENERAL FAN)

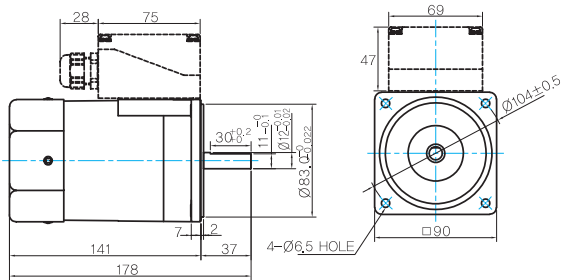

- MOTOR OUTPUT SHAFT

MODEL	SPEC
D-CUT TYPE	
KEY TYPE	
9IDD□-150F	
9IDK□-150F	

- KEY SPEC

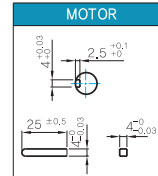

INTER-DECIMAL GEARBOX

- MODEL:
9XD10□□

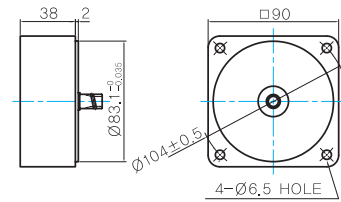

GEARED MOTOR

H TYPE GEARBOX

- MOTOR MODEL:
9IDG□-150FH (GENERAL FAN)

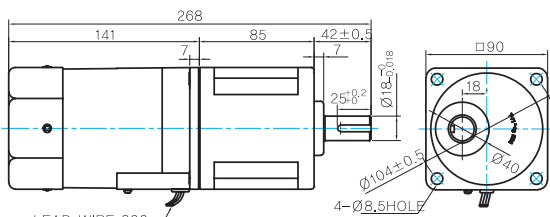

LEAD WIRE 300mm
UL STYLE NO,3271 AWG NO,22

- GEARBOX MODEL:
9HBK□BH

- GEARBOX MODEL:
9HFK□BH

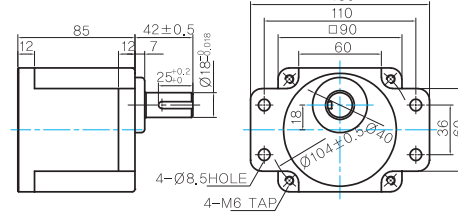

- GEARBOX OUTPUT SHAFT

MODEL	SPEC
KEY TYPE	
9HBK□BH	
9HFK□BH	

- KEY SPEC

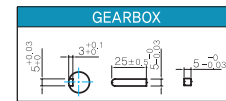

WH TYPE GEARBOX

- MOTOR MODEL:
9IDG□-150FWH (GENERAL FAN)

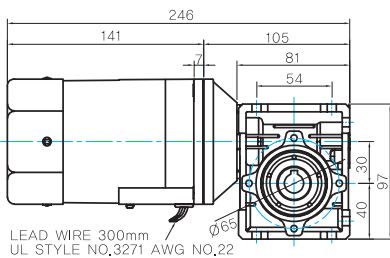

LEAD WIRE 300mm
UL STYLE NO,3271 AWG NO,22

- GEARBOX MODEL:
9WHD□-030

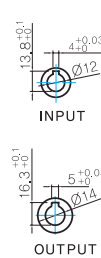
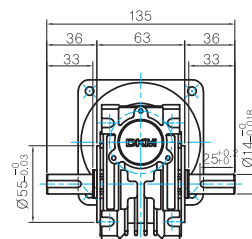

- SHAFT(Unidirectional, Bi-directional)

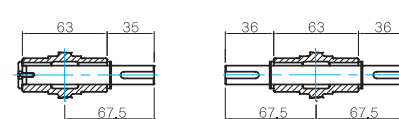

- FLANGE

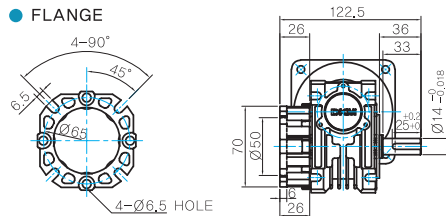

- KEY SPEC

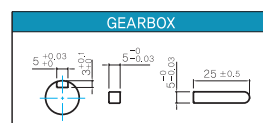

● MOTOR MODEL:
9IDD□-150FWH (GENERAL FAN)

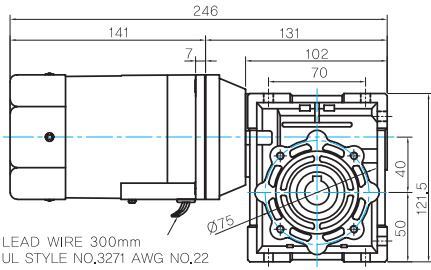

● GEARBOX MODEL:
9WHD□-040

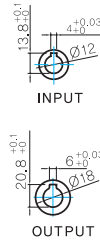
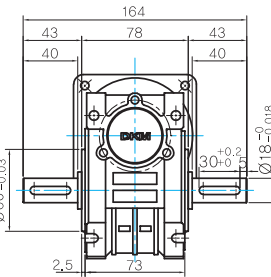

● SHAFT

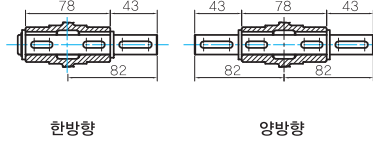

● WEIGHT

PART	WEIGHT(Kg)	
MOTOR	3,0	
GEAR BOX	9HB(F)K3BH ~ 9HB(F)K9BH	1,45
	9HB(F)K12,5BH ~ 9HB(F)K18BH	1,5
	9HB(F)K20BH ~ 9HB(F)K60BH	1,7
	9HB(F)K75BH ~ 9HB(F)K200BH	1,8
	9WHD□-030	1,13
9WHD□-040	2,2	
9XD10□□	0,5	

* 출력 FLANGE와 SHAFT는 별매입니다.

● FLANGE

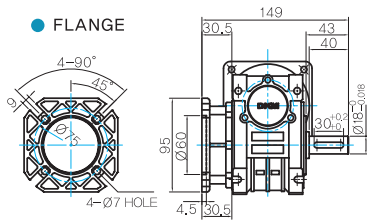

● KEY SPEC

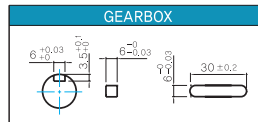

● Motor Images



● Connection Diagrams

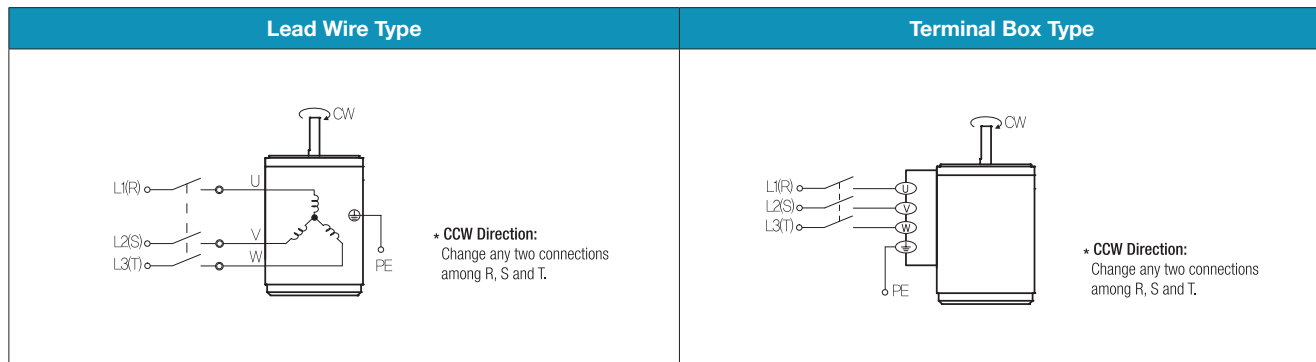

1) The direction of motor rotation is as viewed from the shaft end of the motor.
2) CW represents the clockwise direction, while CCW represents the counterclockwise direction.

B AC Motors

Induction Motor 180W(□90mm)

180W

Induction Motor
180W(□90mm)

Motor Specification

Model		Output W	Voltage V	Frequency Hz	Poles	Duty	Starting Torque		Rated Load			Capacitor μF / VAC	
Lead Wire Type	Terminal Box Type						kgfcm	N.m	Speed r/min	Current A	Torque kgfcm N.m		
9IDG*–180F□(-T): Gear Type Shaft 9IDD*–180F(-T): D–Cut Type Shaft 9IDK*–180F(-T): Key Type Shaft													
9IDGD–180F□	9IDGD–180F□–T	180	1∅220	60	4	Cont.	6.60	0.660	1600	1.20	11.00	1.100	6.5 / 450
9IDGE–180F□	9IDGE–180F□–T	180	1∅220	50	4	Cont.	7.00	0.700	1250	1.50	14.00	1.400	8.0 / 450
			1∅240				7.80	0.780		1.60	14.80	1.480	

- 1) Enter the phase & voltage code in the place * and enter the model type of attaching Gearbox in the box (□) within the motor model name.
- 2) All models contain a built-in thermal protector.
- 3) Gear Type Shaft is for attaching Gearbox and D-Cut & Key Type Shafts are for using motor only.

Max. Permissible Torque at Output Shaft of Gearbox

60Hz

Motor Model	Gearbox Model	Gear Ratio r/min	3	3.6	6	9	12.5	15	18	20	25	30	36	50	60	75	90	100	120	150	180	200
			600	500	300	200	144	120	100	90	72	60	50	36	30	24	20	18	15	12	10	9
9IDG□ –180FH	9HBK□BH 9HFK□BH	kgfcm	27.4	32.9	54.8	82.2	103.1	123.8	148.5	149.6	187.0	224.4	269.3	300.0	300.0	300.0	300.0	300.0	300.0	300.0	300.0	300.0
		N.m	2.68	3.22	5.37	8.05	10.11	12.13	14.55	14.66	18.33	21.99	26.39	29.40	29.40	29.40	29.40	29.40	29.40	29.40	29.40	29.40

Motor Model	Gearbox Model	Gear Ratio r/min	7.5	10	15	20	25	30	40	50	60	80	100
			240	180	120	90	72	60	45	36	30	22.5	18
9IDG□–180FWH	9WHD□–030	kgfcm	69.3	89.1	125.4	158.4	181.5	204.1	183.7	173.5	163.3	132.7	–
		N.m	6.79	8.73	12.29	15.52	17.79	20.00	18.00	17.00	16.00	13.00	–
	9WHD□–040	kgfcm	–	–	–	–	–	–	–	265.0	300.0	295.0	270.0
		N.m	–	–	–	–	–	–	–	25.98	29.41	28.92	26.47

50Hz

Motor Model	Gearbox Model	Gear Ratio r/min	3	3.6	6	9	12.5	15	18	20	25	30	36	50	60	75	90	100	120	150	180	200
			500	417	250	167	120	100	83	75	60	50	42	30	25	20	17	15	13	10	8	7.5
9IDG□ –180FH	9HBK□BH 9HFK□BH	kgfcm	34.9	41.8	69.7	104.6	131.3	157.5	189.0	190.4	238.0	285.6	300.0	300.0	300.0	300.0	300.0	300.0	300.0	300.0	300.0	300.0
		N.m	3.42	4.10	6.83	10.25	12.86	15.44	18.52	18.66	23.32	27.99	29.40	29.40	29.40	29.40	29.40	29.40	29.40	29.40	29.40	29.40

Motor Model	Gearbox Model	Gear Ratio r/min	7.5	10	15	20	25	30	40	50	60	80	100
			200	150	100	75	60	50	37.5	30	25	18.75	15
9IDG□–180FWH	9WHD□–030	kgfcm	88.2	113.4	159.6	183.7	214.3	204.1	183.7	173.5	163.3	132.7	–
		N.m	6.98	8.97	12.62	15.95	18.28	20.00	18.00	17.00	16.00	13.00	–
	9WHD□–040	kgfcm	–	–	–	–	–	–	–	340.0	330.0	295.0	270.0
		N.m	–	–	–	–	–	–	–	33.33	32.35	28.92	26.47

- 1) Enter the phase & voltage code in the box (□) within the motor model name.
- 2) Enter the gear ratio in the box (□) within the Gearbox model name.
- 3) A colored background indicates gear shaft rotation in the same direction as the motor shaft; a white background indicates rotation in the opposite direction.
- 4) The rotating speed is calculated by dividing the motor's synchronous speed (50Hz: 1,500r/min, 60Hz: 1,800r/min) by the gear ratio. The actual speed is 2~20% less than the displayed value, depending on the size of the load.

Dimensions

MOTOR ONLY

- MOTOR MODEL:
9IDD□-180F(-T) (GENERAL FAN)

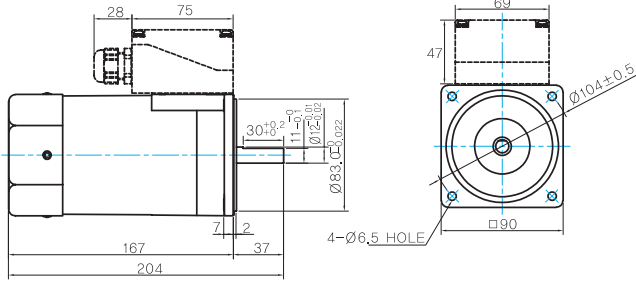

MOTOR OUTPUT SHAFT

MODEL	SPEC
D-CUT TYPE	
9IDD□-180F	
KEY TYPE	
9IDK□-180F	

KEY SPEC

MOTOR

INTER-DECIMAL GEARBOX

- MODEL:
9XD10□□

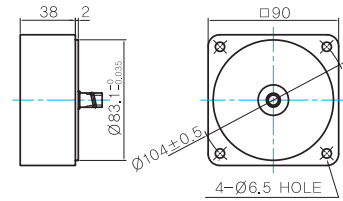

GEARED MOTOR

H TYPE GEARBOX

- MOTOR MODEL:
9IDG□-180FH (GENERAL FAN)

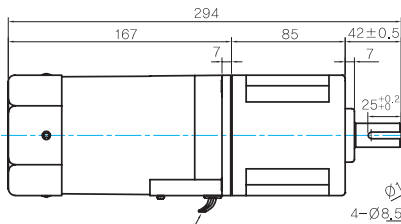

LEAD WIRE 300mm
UL STYLE NO.3271 AWG NO.22

- GEARBOX MODEL:
9HBK□BH

- GEARBOX MODEL:
9HFK□BH

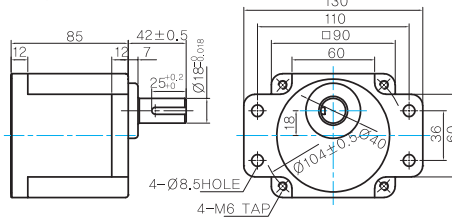

- GEARBOX OUTPUT SHAFT

MODEL	SPEC
KEY TYPE	
9HBK□BH 9HFK□BH	

- KEY SPEC

GEARBOX

WH TYPE GEARBOX

- MOTOR MODEL:
9IDG□-180FWH (GENERAL FAN)

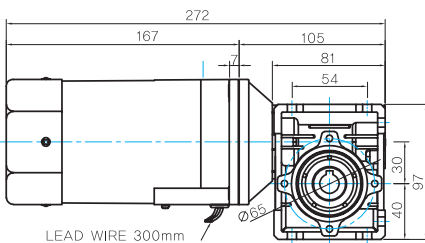

LEAD WIRE 300mm
UL STYLE NO.3271 AWG NO.22

- GEARBOX MODEL:
9WHD□-030

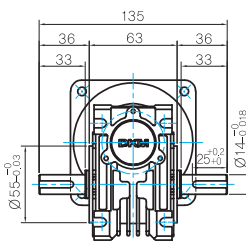

- SHAFT(Unidirectional, Bi-directional)

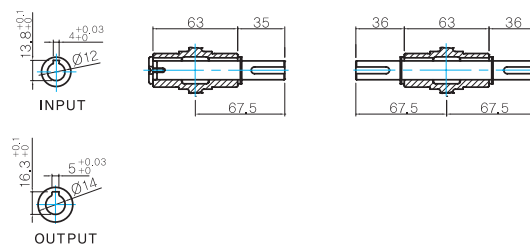

- FLANGE

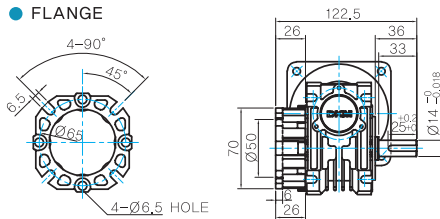

- KEY SPEC

GEARBOX

B AC Motors

Induction Motor 180W(□90mm)

Dimensions

● MOTOR MODEL:
9IDG□-180FWH (GENERAL FAN)

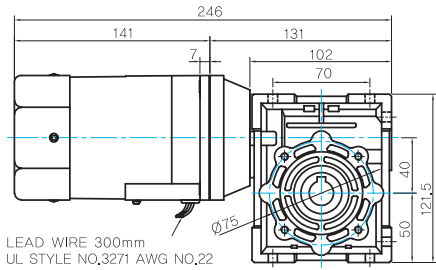

● FLANGE

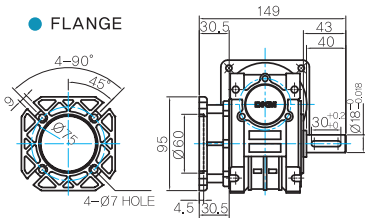

● GEARBOX MODEL:
9WHD□-040

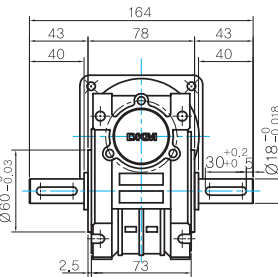

● KEY SPEC

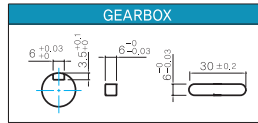

● SHAFT(Unidirectional, Bi-directional)

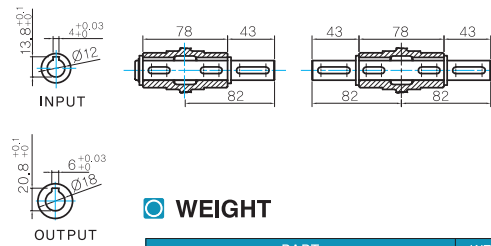

WEIGHT

PART	WEIGHT(Kg)	
MOTOR	3,0	
GEAR BOX	9HB(F)K3BH ~ 9HB(F)K9BH	1,45
	9HB(F)K12.5BH ~ 9HB(F)K18BH	1,5
	9HB(F)K20BH ~ 9HB(F)K60BH	1,7
	9HB(F)K75BH ~ 9HB(F)K200BH	1,8
	9WHD□-030	1,13
	9WHD□-040	2,2
9XD10□□	0,5	

* The output flange and shafts are sold separately.

Motor Images



Connection Diagrams

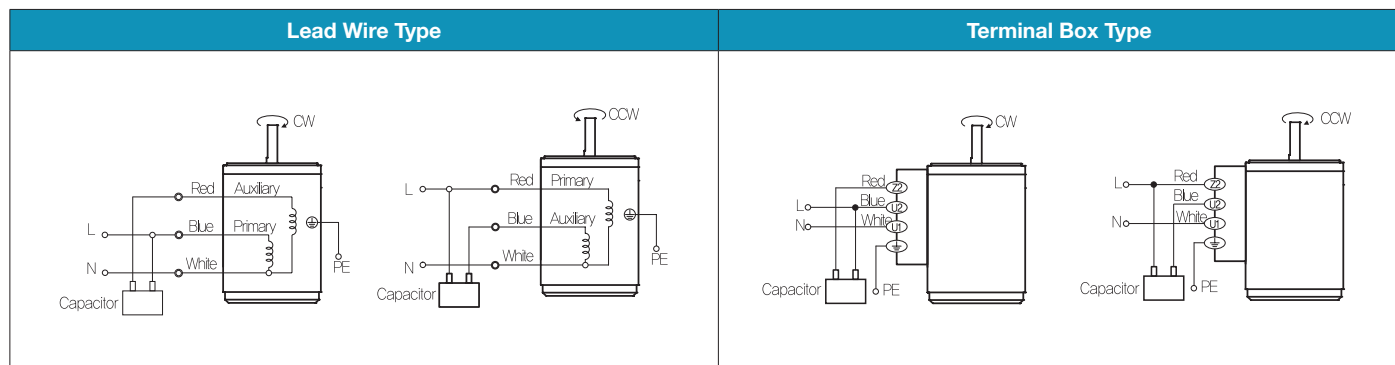

- 1) The direction of motor rotation is as viewed from the shaft end of the motor.
- 2) CW represents the clockwise direction, while CCW represents the counterclockwise direction.
- 3) Change the direction of single phase motor rotation only after bringing the motor to a stop. If an attempt is made to change the direction of rotation while the motor is rotating, the motor may ignore the reversing command or change its direction after some delay.

Induction Motor 200W(□90mm)

200W

Induction Motor
200W(□90mm)

Induction Motor 200W(□90mm)

Motor Specification

Model		Output W	Voltage V	Frequency Hz	Poles	Duty	Starting Torque		Rated Load			Capacitor μF / VAC	
Lead Wire Type	Terminal Box Type						kgfcm	N.m	Speed r/min	Current A	Torque kgfcm N.m		
9IDG*-200F□(-T): Gear Type Shaft 9IDD*-200F(-T): D-Cut Type Shaft 9IDK*-200F(-T): Key Type Shaft	9IDGG-200F□-T	200	3∅220	50	4	Cont.	32.00	3.200	1300	1.40	15.00	1,500	-
				60			27.00	2.700	1550	1.20	13.00	1,300	
9IDGK-200F□	9IDGK-200F□-T	200	3∅380	50	4	Cont.	26.00	2.600	1300	0.69	15.00	1,500	-
				60			22.00	2.200	1550	0.61	12.80	1,280	
			3∅400	50	4	Cont.	30.00	3.000	1300	0.75	15.00	1,500	
				60			25.00	2.500	1600	0.60	12.20	1,220	

1) Enter the phase & voltage code in the place * and enter the model type of attaching Gearbox in the box (□) within the motor model name.

2) All models contain a built-in thermal protector.

3) Gear Type Shaft is for attaching Gearbox and D-Cut & Key Type Shafts are for using motor only.

Max. Permissible Torque at Output Shaft of Gearbox

60Hz

Motor Model	Gearbox Model	Gear Ratio	3	3.6	6	9	12.5	15	18	20	25	30	36	50	60	75	90	100	120	150	180	200	
			r/min	600	500	300	200	144	120	100	90	72	60	50	36	30	24	20	18	15	12	10	9
9IDG□-200FH	9HBK□BH 9HFK□BH	kgfcm	32.4	38.8	64.7	97.1	121.9	146.3	175.5	176.8	221.0	265.2	300.0	300.0	300.0	300.0	300.0	300.0	300.0	300.0	300.0	300.0	300.0
		N.m	3.17	3.81	6.34	9.52	11.94	14.33	17.20	17.33	21.66	25.99	29.40	29.40	29.40	29.40	29.40	29.40	29.40	29.40	29.40	29.40	29.40

Motor Model	Gearbox Model	Gear Ratio	7.5	10	15	20	25	30	40	50	60	80	100
			r/min	240	180	120	90	72	60	45	36	30	22.5
9IDG□-200FWH	9WHD□-030 9WHD□-040	kgfcm	81.9	105.3	148.2	183.7	214.3	204.1	183.7	173.5	163.3	132.7	-
		N.m	8.02	10.32	14.52	18.00	21.00	20.00	18.00	17.00	16.00	13.00	-
		kgfcm	-	-	-	-	-	-	-	315.0	330.0	295.0	270.0
		N.m	-	-	-	-	-	-	-	30.88	32.35	28.92	26.47

50Hz

Motor Model	Gearbox Model	Gear Ratio	3	3.6	6	9	12.5	15	18	20	25	30	36	50	60	75	90	100	120	150	180	200	
			r/min	500	417	250	167	120	100	83	75	60	50	42	30	25	20	17	15	13	10	8	7.5
9IDG□-200FH	9HBK□BH 9HFK□BH	kgfcm	37.4	44.8	74.7	112.1	140.6	168.8	202.5	204.0	255.0	300.0	300.0	300.0	300.0	300.0	300.0	300.0	300.0	300.0	300.0	300.0	300.0
		N.m	3.66	4.39	7.32	10.98	13.78	16.54	19.85	19.99	24.99	29.40	29.40	29.40	29.40	29.40	29.40	29.40	29.40	29.40	29.40	29.40	29.40

Motor Model	Gearbox Model	Gear Ratio	7.5	10	15	20	25	30	40	50	60	80	100
			r/min	200	150	100	75	60	50	37.5	30	25	18.75
9IDG□-200FWH	9WHD□-030 9WHD□-040	kgfcm	94.5	121.5	171.0	183.7	214.3	204.1	183.7	173.5	163.3	132.7	-
		N.m	9.26	11.91	16.76	18.00	21.00	20.00	18.00	17.00	16.00	13.00	-
		kgfcm	-	-	-	-	-	-	-	350.0	330.0	295.0	270.0
		N.m	-	-	-	-	-	-	-	34.31	32.35	28.92	26.47

1) Enter the phase & voltage code in the box (□) within the motor model name.

2) Enter the gear ratio in the box (□) within the Gearbox model name.

3) A colored background indicates gear shaft rotation in the same direction as the motor shaft; a white background indicates rotation in the opposite direction.

4) The rotating speed is calculated by dividing the motor's synchronous speed (50Hz: 1,500r/min, 60Hz: 1,800r/min) by the gear ratio.

The actual speed is 2~20% less than the displayed value, depending on the size of the load.

B AC Motors

Induction Motor 200W(□90mm)

Dimensions

MOTOR ONLY

- MOTOR MODEL:
9IDD□-200F(-T) (GENERAL FAN)

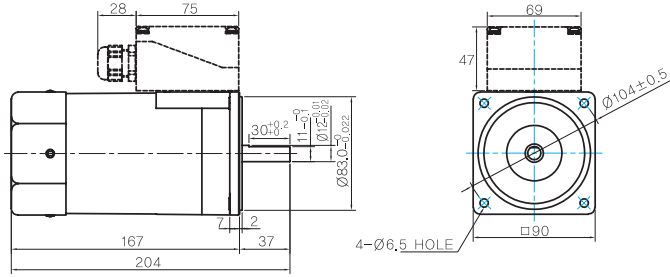

MOTOR OUTPUT SHAFT

MODEL	SPEC
D-CUT TYPE	
9IDD□-200F	
KEY TYPE	
9IDK□-200F	

KEY SPEC

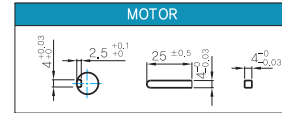

INTER-DECIMAL GEARBOX

- MODEL:
9XD10□□

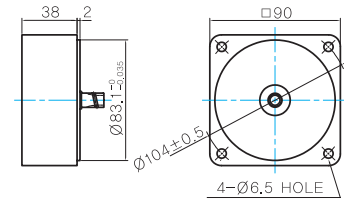

GEARED MOTOR

H TYPE GEARBOX

- MOTOR MODEL:
9IDG□-200FH (GENERAL FAN)

- GEARBOX MODEL:
9HBK□BH
- GEARBOX MODEL:
9HFK□BH

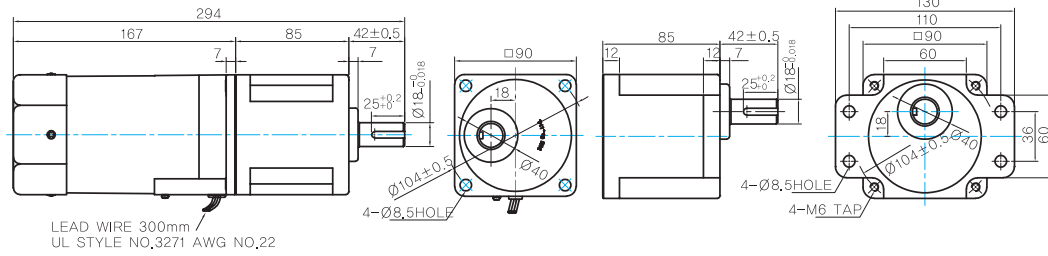

LEAD WIRE 300mm
UL STYLE NO.3271 AWG NO.22

GEARBOX OUTPUT SHAFT

MODEL	SPEC
KEY TYPE	
9HBK□BH	
9HFK□BH	

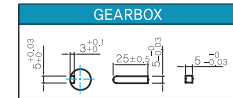

WH TYPE GEARBOX

- MOTOR MODEL:
9IDG□-200FWH (GENERAL FAN)

- GEARBOX MODEL:
9WHD□-030

- SHAFT(Unidirectional, Bi-directional)

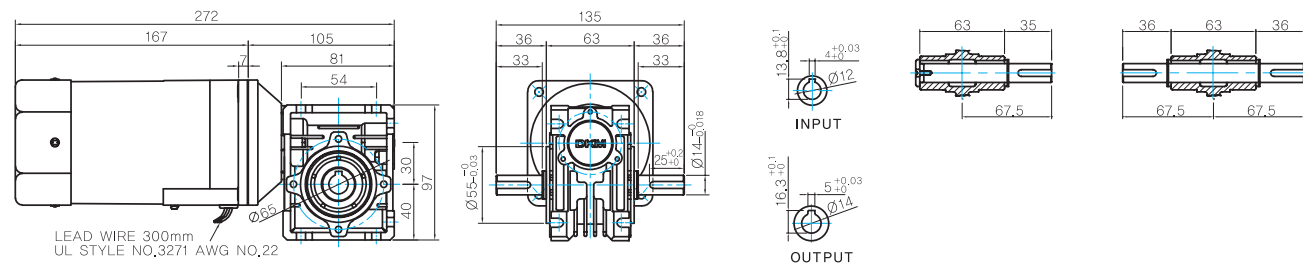

LEAD WIRE 300mm
UL STYLE NO.3271 AWG NO.22

FLANGE

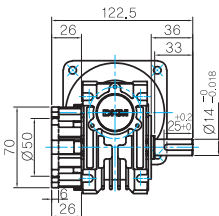
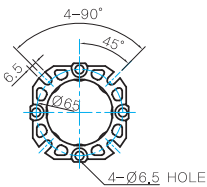

KEY SPEC

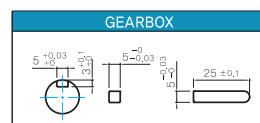

● MOTOR MODEL:
9IDD□-200FWH (GENERAL FAN)

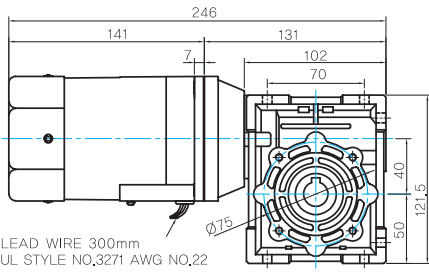

LEAD WIRE 300mm
UL STYLE NO.3271 AWG NO.22

● GEARBOX MODEL:
9WHD□-040

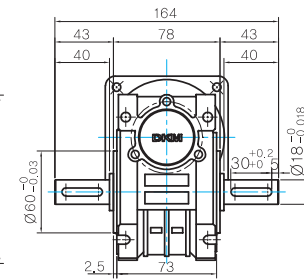

● SHAFT(Unidirectional, Bi-directional)

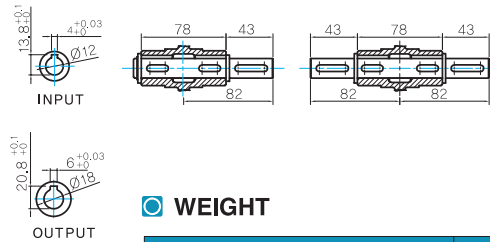

● FLANGE

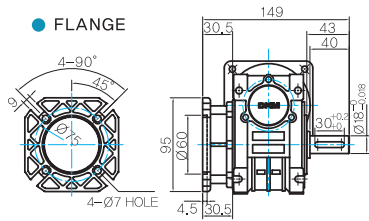

● KEY SPEC

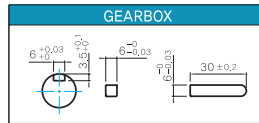

● WEIGHT

	PART	WEIGHT(Kg)
GEAR BOX	MOTOR	3.0
	9HB(F)K3BH ~ 9HB(F)K9BH	1.45
	9HB(F)K12.5BH ~ 9HB(F)K18BH	1.5
	9HB(F)K20BH ~ 9HB(F)K60BH	1.7
	9HB(F)K75BH ~ 9HB(F)K200BH	1.8
	9WHD□-030	1.13
	9WHD□-040	2.2
	9XD10□□	0.5

* The output flange and shafts are sold separately.

Motor Images



Connection Diagrams

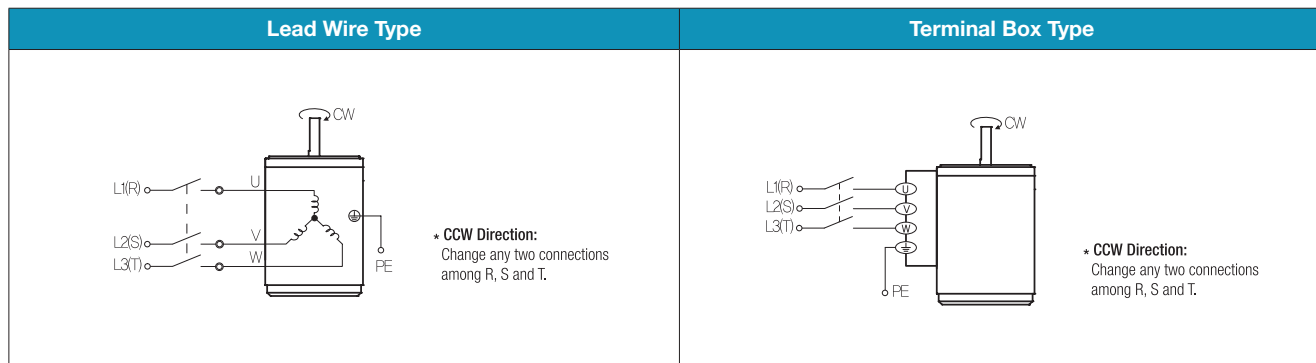

1) The direction of motor rotation is as viewed from the shaft end of the motor.
2) CW represents the clockwise direction, while CCW represents the counterclockwise direction.

B AC Motors

Induction Motor 250W(□104mm)

250W

Induction Motor
250W(□104mm)

Motor Specification

Model		Output W	Voltage V	Frequency Hz	Poles	Duty	Starting Torque		Rated Load			Capacitor μF / VAC	
Lead Wire Type	Terminal Box Type						kgfcm	N.m	Speed r/min	Current A	Torque kgfcm N.m		
-	10IDGE-250F□-T	250	1∅ 220	50	4	Cont.	11.00	1,100	1250	2.29	19.48	1.948	13.0/450
			1∅ 240				13.50	1,350	1300	2.17	18.74	1.874	

- 1) Enter the phase & voltage code in the place * and enter the model type of attaching gearbox in the box (□) within the motor model name.
 2) voltage code E & D contain a built-in thermal protector.
 3) Gear Type Shaft is for attaching gearbox and D-Cut & Key Type Shafts are for using motor only.

Max. Permissible Torque at Output Shaft of Gearbox

50Hz

Motor Model	Gearbox Model	Ratio r/min	3	3.6	5	6	7.5	9	10	12.5	15	18	20	25	30	36	40	50	60	75	90	100	120	150	180	
10IDGE-250FU-T	10UBK□ BH	kgfcm	50	60	80	100	120	145	150	185	220	240	270	300	300	350	350	350	400	400	400	400	400	400	400	400
		N.m	4.9	5.9	7.8	9.8	12	14	15	18	22	24	26	29	29	34	34	34	34	39	39	39	39	39	39	39

Motor Model	Gearbox Model	Gear Ratio r/min	7.5	10	15	20	25	30	40	50	60	80	100
10IDGE-250WH-T	10WHD□-040	kgfcm	100	130	190	240	290	325	305	*	*	*	*
		N.m	9.8	12.7	18.6	23.5	28.4	31.8	29.9	*	*	*	*

Dimensions

MOTOR ONLY

- MOTOR MODEL:
10IDK□-250F-T

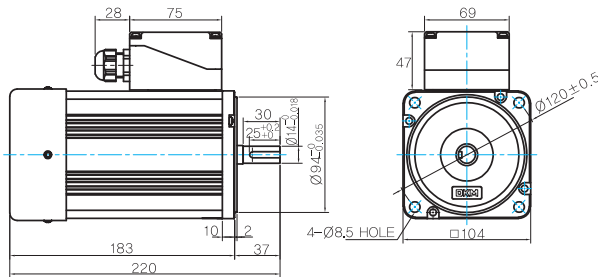

● MOTOR OUTPUT SHAFT

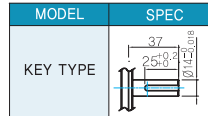

● KEY SPEC

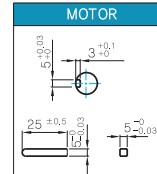

GEARED MOTOR

U TYPE GEARBOX

- MOTOR MODEL:
10IDG□-250FU-T

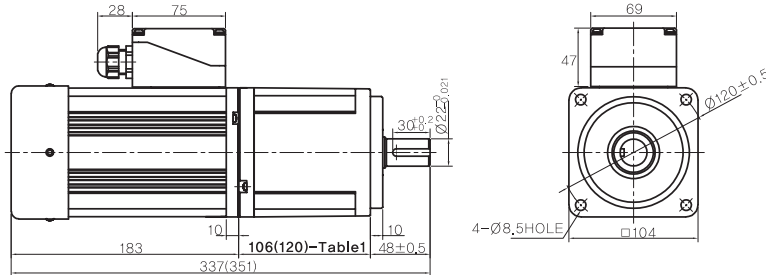

- GEARBOX MODEL:
10UBK□BH

● GEARBOX OUTPUT SHAFT

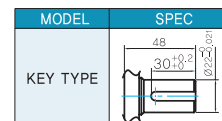

● KEY SPEC

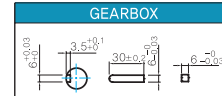

● 106(120)-Table1

SIZE(mm)	GEAR RATIO
106	10UBK3BH - 10UBK60BH
120	10UBK75BH - 10UBK180BH

WH TYPE GEARBOX

- MOTOR MODEL:
10IDG□-250FWH-T

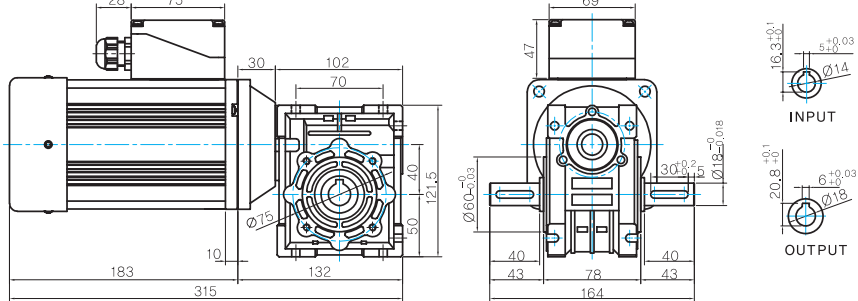

- GEARBOX MODEL:
10WHD□-040

● SHAFT

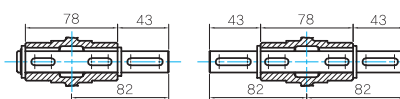

한방향

양방향

WEIGHT

PART		WEIGHT(Kg)
MOTOR		6.1
GEAR BOX	10UBK3BH ~ 10UBK10BH	2.1
	10UBK12.5BH ~ 10UBK18BH	2.15
	10UBK20BH ~ 10UBK60BH	2.2
	10UBK75BH ~ 10UBK200BH	2.3
	10WHD□-040	2.2

* 출력 FLANGE와 SHAFT는 별매입니다.

● FLANGE

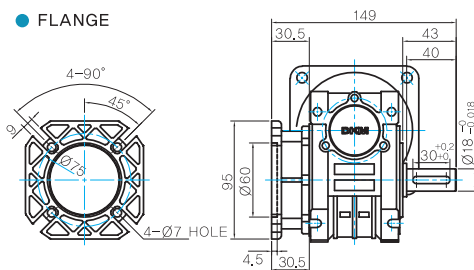

● KEY SPEC

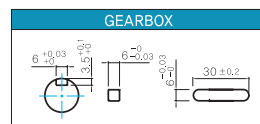

B AC Motors

Induction Motor 250W(□104mm)

Motor Images

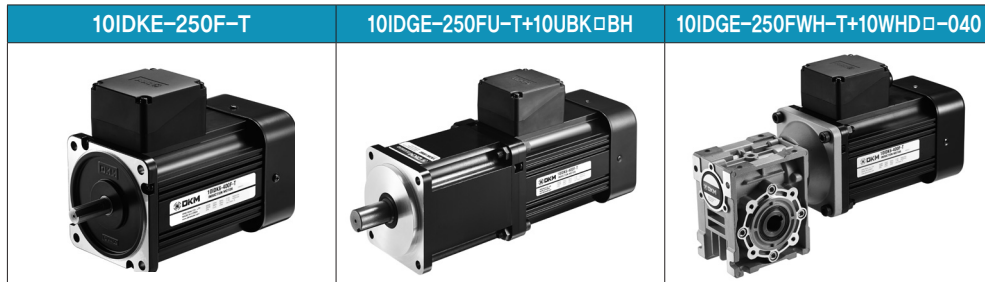

Connection Diagrams

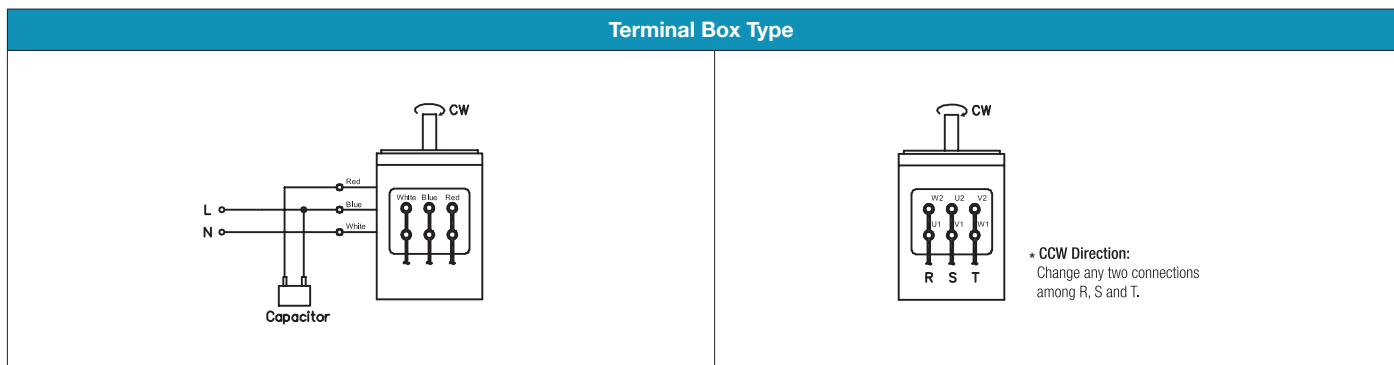

- 1) The direction of motor rotation is as viewed from the shaft end of the motor.
- 2) CW represents the clockwise direction, while CCW represents the counterclockwise direction.

Induction Motor 250W(□ 104mm)

300W Induction Motor 300W(□ 104mm)

Induction Motor 300W(□ 104mm)

Motor Specification

Model		Output W	Voltage V	Frequency Hz	Poles	Duty	Starting Torque		Rated Load			Capacitor μF / VAC	
Lead Wire Type	Terminal Box Type						kgfcm	N.m	Speed r/min	Current A	Torque kgfcm N.m		
-	10IDGD-300F□-T	300	1Ø 220	60	4	Cont.	13.60	1.360	1600	2.52	18.27	1.827	15.0 / 450
-	10IDG7-300F□-T	300	3Ø 230	50	4	Cont.	47.00	4.700	1300	1.70	22.48	2.248	-
			3Ø 400				47.00	4.700	1300	1.01	22.48	2.248	
-	10IDG8-300F□-T	300	3Ø 440	50	4	Cont.	47.00	4.700	1300	0.88	22.48	2.248	-
				60			35.00	3.500	1550	0.88	18.86	1.886	

1) Enter the phase & voltage code in the place * and enter the model type of attaching gearbox in the box (□) within the motor model name.

2) voltage code E & D contain a built-in thermal protector.

3) Gear Type Shaft is for attaching gearbox and D-Cut & Key Type Shafts are for using motor only.

Max. Permissible Torque at Output Shaft of Gearbox

50Hz

Motor Model	Gearbox Model	Ratio r/min	3	3.6	5	6	7.5	9	10	12.5	15	18	20	25	30	36	40	50	60	75	90	100	120	150	180
			600	500	360	300	240	200	180	144	120	100	90	72	60	50	45	36	30	24	20	18	15	12	10
10IDG7-300FU-T	10UBK	kgfcm	55	70	95	110	140	170	170	210	250	270	300	300	300	350	350	350	400	400	400	400	400	400	400
10IDG8-300FU-T	□BH	N.m	5.4	6.9	9.3	11	14	17	17	21	25	26	29	29	29	34	34	34	39	39	39	39	39	39	39

Motor Model	Gearbox Model	Gear Ratio r/min	7.5	10	15	20	25	30	40	50	60	80	100
			200	150	100	75	60	50	37.5	30	25	18.75	15
10IDG7-300FWH-T	10WHD□-040	kgfcm	95	125	175	225	270	300	285	*	*	*	*
10IDG8-300FWH-T		N.m	9.30	12.20	17.10	22.00	26.40	29.40	27.90	*	*	*	*

60Hz

Motor Model	Gearbox Model	Ratio r/min	3	3.6	5	6	7.5	9	10	12.5	15	18	20	25	30	36	40	50	60	75	90	100	120	150	180
			600	500	360	300	240	200	180	144	120	100	90	72	60	50	45	36	30	24	20	18	15	12	10
10IDGD-300FU-T	10UBK	kgfcm	45	55	75	90	115	135	140	170	205	225	250	300	300	350	350	350	400	400	400	400	400	400	400
10IDG8-300FU-T	□BH	N.m	4.41	5.39	7.35	8.82	11.27	13.23	13.72	16.66	20.09	22.05	24.5	29.4	29.4	34.3	34.3	34.3	39.2	39.2	39.2	39.2	39.2	39.2	39.2

Motor Model	Gearbox Model	Gear Ratio r/min	7.5	10	15	20	25	30	40	50	60	80	100
			200	150	100	75	60	50	37.5	30	25	18.75	15
10IDGD-300FWH-T	10WHD□-040	kgfcm	115	150	215	275	335	375	350	*	*	*	*
10IDG8-300FWH-T		N.m	11.20	14.70	21.00	26.90	32.80	36.70	34.30	*	*	*	*

B AC Motors

Induction Motor 300W(□104mm)

Dimensions

MOTOR ONLY

MOTOR MODEL:
10IDK□-300F-T

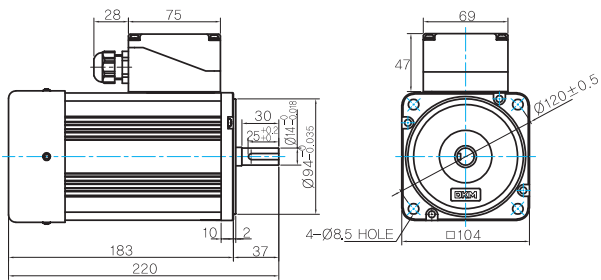

MOTOR OUTPUT SHAFT

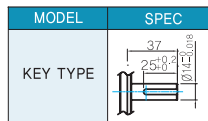

KEY SPEC

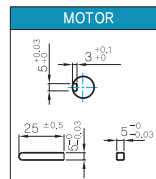

GEARED MOTOR

U TYPE GEARBOX

MOTOR MODEL:
10IDG□-300FU-T

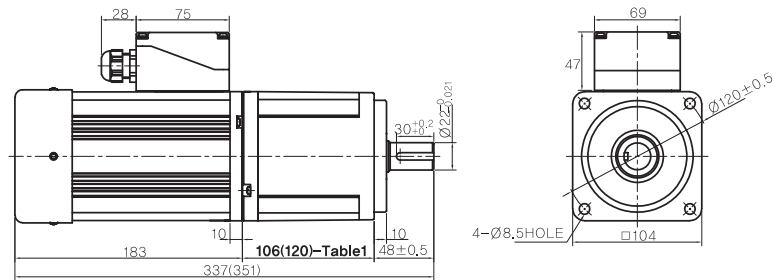

GEARBOX MODEL:
10UBK□BH-040

GEARBOX OUTPUT SHAFT

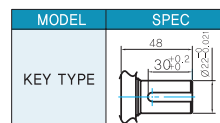

KEY SPEC

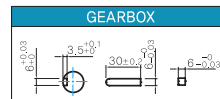

106(120)-Table1

SIZE(mm)	GEAR RATIO
106	10UBK3BH - 10UBK60BH
120	10UBK75BH - 10UBK180BH

WH TYPE GEARBOX

MOTOR MODEL:
10IDG□-300FWH-T

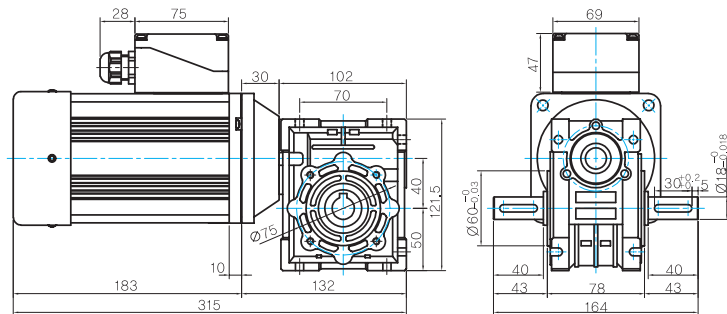

GEARBOX MODEL:
10WHD□-040

SHAFT

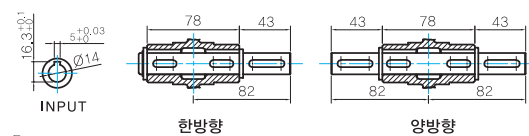

FLANGE

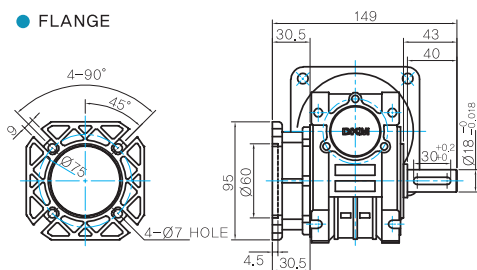

KEY SPEC

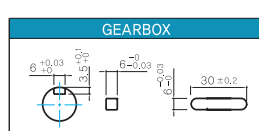

WEIGHT

PART	WEIGHT(kg)	
MOTOR	6.1	
GEAR BOX	10UBK3BH ~ 10UBK10BH	2.1
	10UBK12.5BH ~ 10UBK18BH	2.15
	10UBK20BH ~ 10UBK60BH	2.2
	10UBK75BH ~ 10UBK200BH	2.3
	10WHD□-040	2.2

* 출력 FLANGE와 SHAFT는 별매입니다.

Motor Images

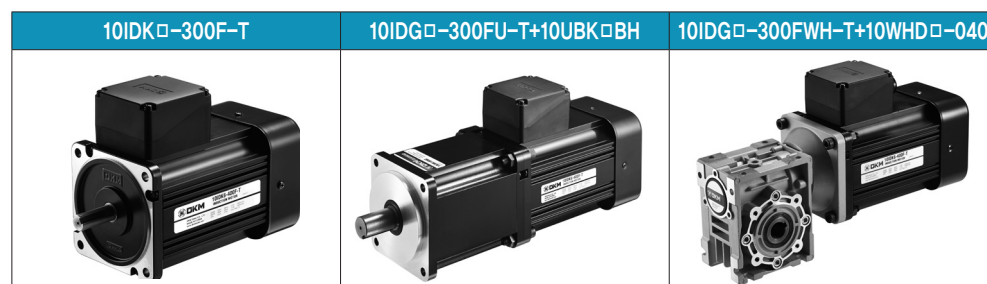

Connection Diagrams

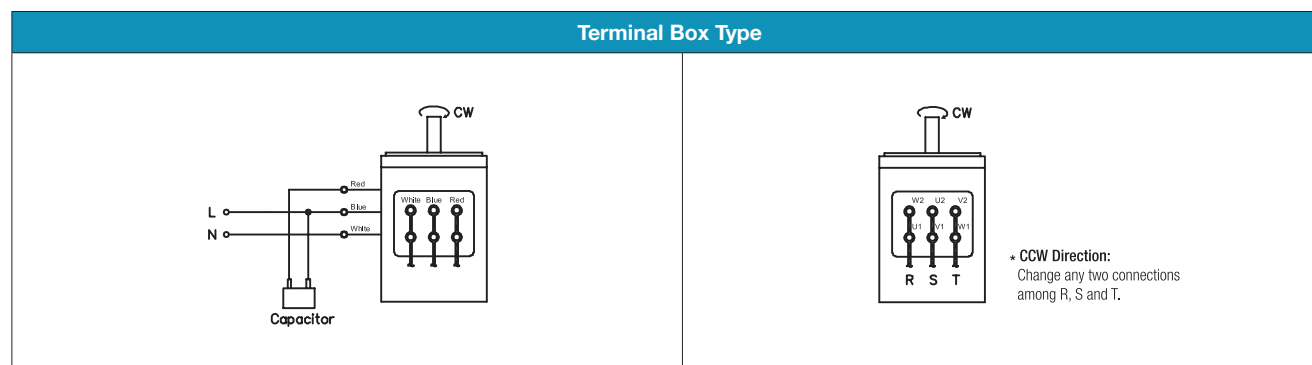

- 1) The direction of motor rotation is as viewed from the shaft end of the motor.
- 2) CW represents the clockwise direction, while CCW represents the counterclockwise direction.

B AC Motors

Induction Motor 400W(□104mm)

400W

 Induction Motor
400W(□104mm)

Motor Specification

Model		Output W	Voltage V	Frequency Hz	Poles	Duty	Starting Torque		Rated Load			Capacitor μF / VAC	
Lead Wire Type	Terminal Box Type						kgfcm N.m	Speed r/min	Current A	Torque kgfcm N.m			
-	10IDG6-400F□-T	400	3∅ 220	60	4	Cont.	47.00	4.700	1600	2.10	24.35	2.435	-
			3∅ 380				47.00	4.700	1600	1.21	24.35	2.435	

- 1) Enter the phase & voltage code in the place * and enter the model type of attaching gearbox in the box (□) within the motor model name.
- 2) voltage code E & D contain a built-in thermal protector.
- 3) Gear Type Shaft is for attaching gearbox and D-Cut & Key Type Shafts are for using motor only.

Max. Permissible Torque at Output Shaft of Gearbox

60Hz

Motor Model	Gearbox Model	Ratio r/min	3 600	3.6 500	5 360	6 300	7.5 240	9 200	10 180	12.5 144	15 120	18 100	20 90	25 72	30 60	36 50	40 45	50 36	60 30	75 24	90 20	100 18	120 15	150 12	180 10
10IDG6-400FU-T	10UBK□ BH	kgfcm N.m	60 5.9	75 7.4	100 9.8	120 12	150 15	180 18	185 18	225 22	275 27	300 29	300 29	300 29	300 29	350 34	350 34	350 34	400 39	400 39	400 39	400 39	400 39	400 39	400 39

Motor Model	Gearbox Model	Gear Ratio r/min	7.5 200	10 150	15 100	20 75	25 60	30 50	40 37.5	50 30	60 25	80 18.75	100 15
10IDG6-400FWH-T	10WHD□-040	kgfcm N.m	125 12.20	160 15.60	230 22.50	295 28.90	355 34.80	395 38.70	375 36.70	*	*	*	*

Dimensions

MOTOR ONLY

MOTOR MODEL:
10IDK6-400F-T

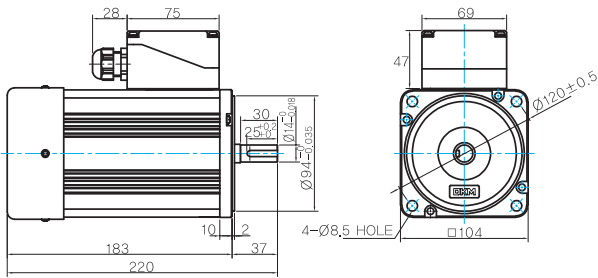

MOTOR OUTPUT SHAFT

MODEL	SPEC
KEY TYPE	

KEY SPEC

MOTOR

GEARED MOTOR

U TYPE GEARBOX

MOTOR MODEL:
10IDG6-400FU-T

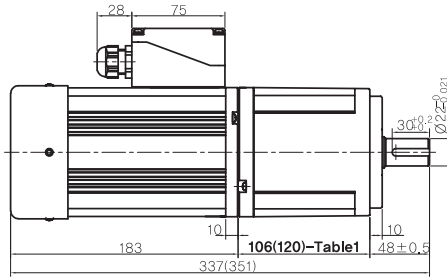

GEARBOX MODEL:
10UBK□BH

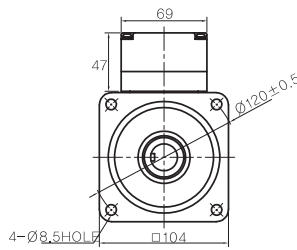

GEARBOX OUTPUT SHAFT

MODEL	SPEC
KEY TYPE	

KEY SPEC

GEARBOX

106(120)-Table1

SIZE(mm)	GEAR RATIO
106	10UBK3BH ~ 10UBK60BH
120	10UBK75BH ~ 10UBK180BH

WH TYPE GEARBOX

MOTOR MODEL:
10IDG6-400FWH-T

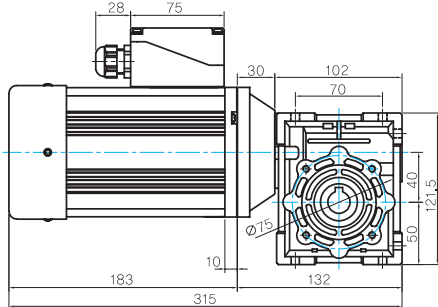

GEARBOX MODEL:
10WHD□-040

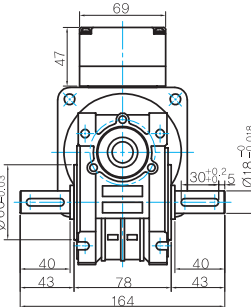

SHAFT

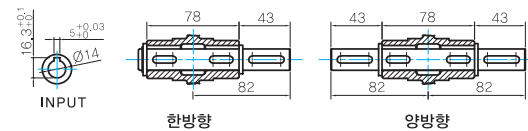

WEIGHT

PART	WEIGHT(Kg)	
MOTOR	6,1	
GEAR BOX	10UBK3BH ~ 10UBK10BH	2,1
	10UBK12.5BH ~ 10UBK18BH	2,15
	10UBK20BH ~ 10UBK60BH	2,2
	10UBK75BH ~ 10UBK200BH	2,3
	10WHD□-040	2,2

* 출력 FLANGE와 SHAFT는 별매입니다.

FLANGE

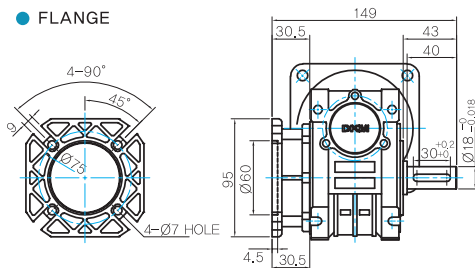

KEY SPEC

GEARBOX

B AC Motors

Induction Motor 400W(□104mm)

Motor Images

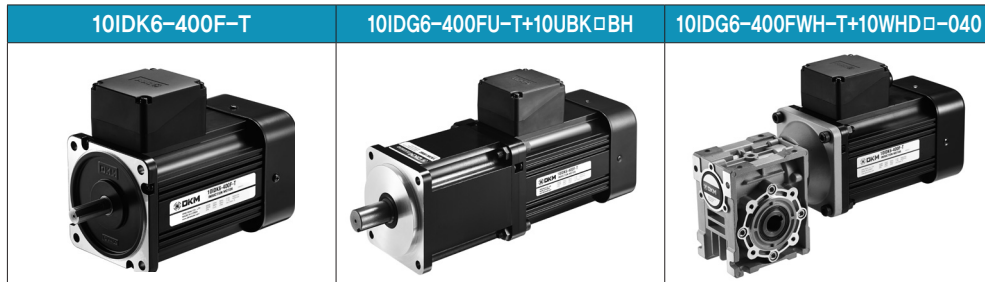

Connection Diagrams

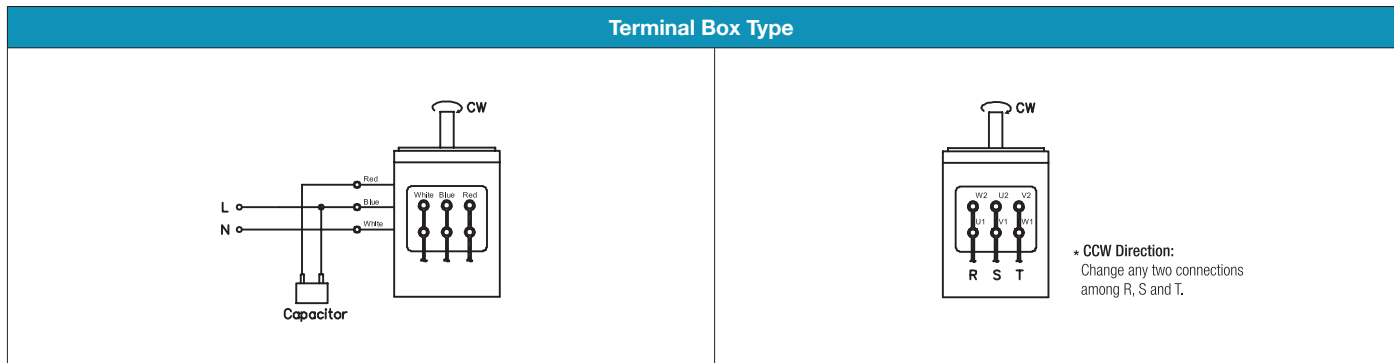

- 1) The direction of motor rotation is as viewed from the shaft end of the motor.
- 2) CW represents the clockwise direction, while CCW represents the counterclockwise direction.

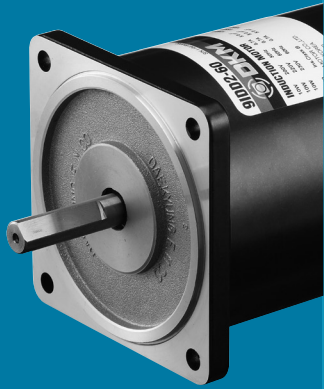

2 Pole Motor

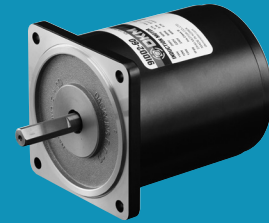

2 Pole Motor

Index

2 Pole Motor 15W (□80mm)	B-57
2 Pole Motor 25W (□80mm)	B-59
2 Pole Motor 40W (□90mm)	B-61
2 Pole Motor 60W (□90mm)	B-63
2 Pole Motor 90W (□90mm)	B-65
2 Pole Motor 120W (□90mm)	B-67
2 Pole Motor 150W (□90mm)	B-69
2 Pole Motor 200W (□90mm)	B-71