

Force

- » Peak: 344 - 860 N
- » Continuous: 52 - 119N

Maximum Velocity

- » Up to 5.6 m/s

Feedback

- » Built-in position sensor
- » 1V pk-pk sin/cos
- » 12 micron repeatability

Range of motion

- » 28~310 mm

Dimensions

- » W x H: 100 x 86mm
- » Rod diameter: 25mm

Applications

- » Packaging
- » Material Handling
- » Automated Assembly
- » Bio-medical

The OEM advantage

- » Ready-to-use actuator requires no bearing support
- » Flexible position control
- » High speed and acceleration
- » Clean, quiet operation
- » No maintenance or adjustment



The ServoTube Actuator high rigidity actuator with integrated outrigger-bearings is an ideal solution for applications with high side-loading. A ball-bushing option with steel bearing rails provides maximum side-loading support. Polymer bushings use aluminium rails for reduced weight and are ideal for vertical loads.

Iron-sleeve design produces up to 20% more force than standard ServoTube actuator. Four models deliver a continuous force range of 61~119N (14~27lb) with peak forces up to 860N (193lb). Twelve stroke lengths are available from 28~310mm.

The patented magnetic design of ServoTube generates 12 micron (0.47 mil) repeatability and 350 micron (14 mil) accuracy from a non-contact, integral position sensor. No external encoder is required. Position output is industry standard 1V pk-pk sin/cos signals.

ServoTube is an ideal OEM solution for easy integration into pick-and-place gantries and general purpose material handling machines. The load is mounted directly to the industry standard mounting plate.

ServoTube has superior thermal efficiency, radiating heat uniformly. High duty cycles are possible without the need for forced-air or water cooling.

ELECTRICAL SPECIFICATIONS

| FORCER TYPE | 2504 | 2506 | 2508 | 2510 | units |
|--|------|-------|-------|-------|------------------|
| Peak force @ 25°C ambient for 1 sec | 344 | 516 | 688 | 860 | N |
| Peak current @ 25°C ambient for 1 sec | 20 | 20 | 20 | 20 | Apk |
| With 25 x 25 x2.5cm heatsink plate | | | | | |
| Continuous stall force @ 25°C ambient ⁽¹⁾ | 60.7 | 81.8 | 101.2 | 119.4 | N |
| Continuous stall current @ 25°C ambient | 2.49 | 2.24 | 2.08 | 1.96 | Arms |
| | 3.53 | 3.17 | 2.94 | 2.78 | Apk |
| Without heatsink plate | | | | | |
| Continuous stall force @ 25°C ambient ⁽¹⁾ | 52.2 | 72.3 | 90.4 | 108.0 | N |
| Continuous stall current @ 25°C ambient | 2.15 | 1.98 | 1.86 | 1.78 | Arms |
| | 3.03 | 2.80 | 2.63 | 2.51 | Apk |
| Force constant (sine commutation) | 24.3 | 36.5 | 48.6 | 60.8 | N/Arms |
| | 17.2 | 25.8 | 34.4 | 43.0 | N/Apk |
| Back EMF constant (phase to phase) | 19.9 | 29.8 | 39.7 | 49.7 | Vpk/m/s |
| Fundamental forcer constant | 7.53 | 9.22 | 10.65 | 11.90 | N/√W |
| Eddy current loss | 2.35 | 2.35 | 2.35 | 2.35 | N/m/s |
| Sleeve cogging force | 2.2 | 3.2 | 3.3 | 3.0 | +/-N |
| Resistance @ 25°C (phase to phase) | 5.40 | 8.11 | 10.81 | 13.51 | Ohm |
| Resistance @ 100°C (phase to phase) | 6.96 | 10.45 | 13.93 | 17.41 | Ohm |
| Inductance @ 1kHz (phase to phase) | 4.32 | 6.48 | 8.64 | 10.80 | mH |
| Electrical time constant | 0.80 | 0.80 | 0.80 | 0.80 | ms |
| Maximum working voltage | 380 | 380 | 380 | 380 | V d.c. |
| Pole pitch (one electrical cycle) | 51.2 | 51.2 | 51.2 | 51.2 | mm |
| Peak acceleration ^(2,4) | 225 | 288 | 334 | 369 | m/s ² |
| Maximum speed ^(3,4) | 5.6 | 5.3 | 4.8 | 4.3 | m/s |
| Peak acceleration ^(2,5) | 276 | 354 | 413 | 458 | m/s ² |
| Maximum speed ^(3,5) | 6.1 | 5.7 | 5.1 | 4.5 | m/s |

Notes:

- ⁽¹⁾ Reduce continuous stall force to 89% at 40°C ambient
⁽²⁾ Based on a moving thrust rod with 28mm stroke and no payload
⁽³⁾ Based on a moving thrust rod with triangular move over maximum stroke and no payload
⁽⁴⁾ -B bush bearing option
⁽⁵⁾ -P polymer bearing option

THERMAL SPECIFICATIONS

| FORCER TYPE | 2504 | 2506 | 2508 | 2510 | units |
|---|------|------|------|-------|---------|
| Maximum phase temperature | 100 | 100 | 100 | 100 | °C |
| Thermal resistance Rth _{phase-housing} | 0.39 | 0.28 | 0.23 | 0.19 | °C/Watt |
| With 25 x 25 x2.5cm heatsink plate | | | | | |
| Power dissipation @ 25°C ambient | 65.0 | 78.8 | 90.4 | 100.6 | Watt |
| Thermal resistance Rth _{housing-ambient} | 0.76 | 0.67 | 0.60 | 0.56 | °C/Watt |
| Without heatsink plate | | | | | |
| Power dissipation @ 25°C ambient | 48.1 | 61.5 | 72.1 | 82.4 | Watt |
| Thermal resistance Rth _{housing-ambient} | 1.17 | 0.94 | 0.81 | 0.72 | °C/Watt |
| Thermal time constant | 1639 | 1773 | 1940 | 2080 | s |

MECHANICAL SPECIFICATIONS

| FORCER TYPE | 2504 | 2506 | 2508 | 2510 | units |
|---|----------------------------------|------|------|------|-------|
| Maximum stroke | 310 | 310 | 310 | 310 | mm |
| Forcer mass | 1.65 | 2.25 | 2.85 | 3.45 | kg |
| Moving mass (-B bush bearing option) | 0.25+(overall length (m) x 5.24) | | | | kg |
| Moving mass (-P polymer bearing option) | 0.25+(overall length (m) x 4.10) | | | | kg |

MECHANICAL RIGIDITY

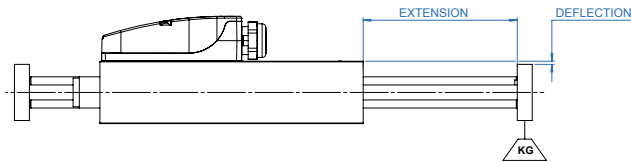

- 0kg
- 2kg
- 5kg
- 10kg

XTR2504 (-B bush bearing)

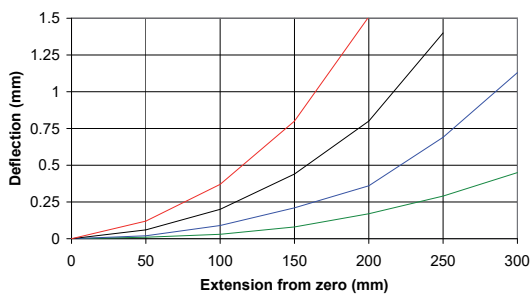

XTR2506 (-B bush bearing)

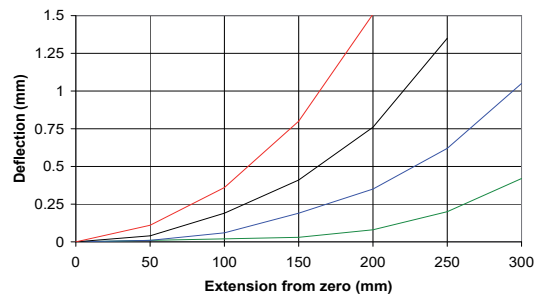

XTR2508 (-B bush bearing)

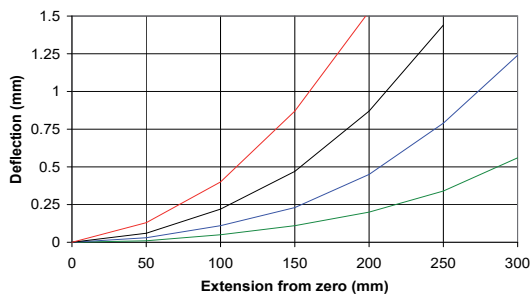

XTR2510 (-B bush bearing)

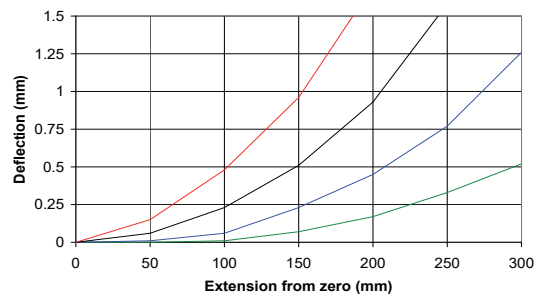

XTR2504 (-P polymer bearing)

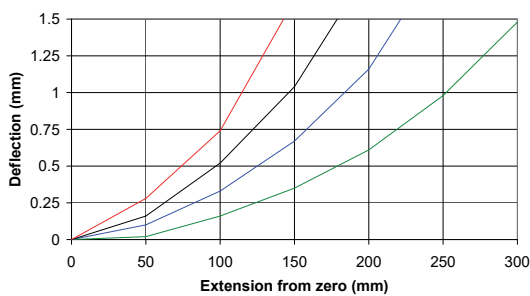

XTR2506 (-P polymer bearing)

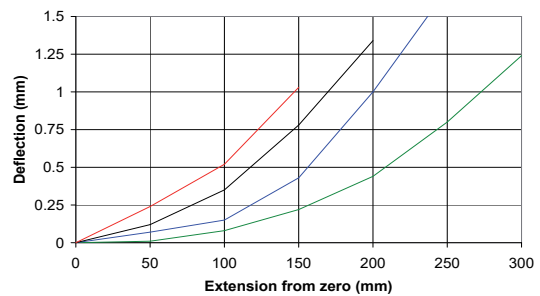

XTR2508 (-P polymer bearing)

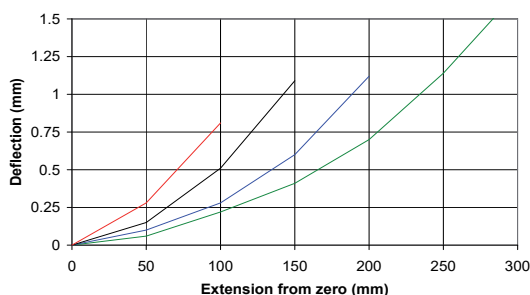

XTR2510 (-P polymer bearing)

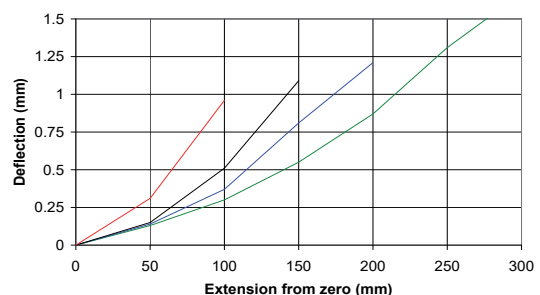

PAYLOAD VERSUS EXTENSION FOR 10.000KM LIFE

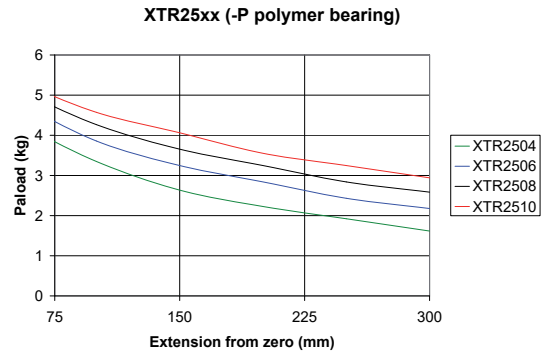
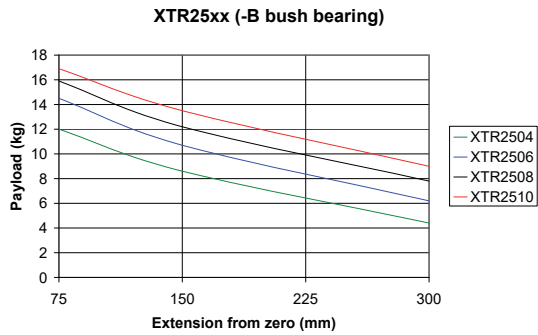

OUTLINE DRAWINGS

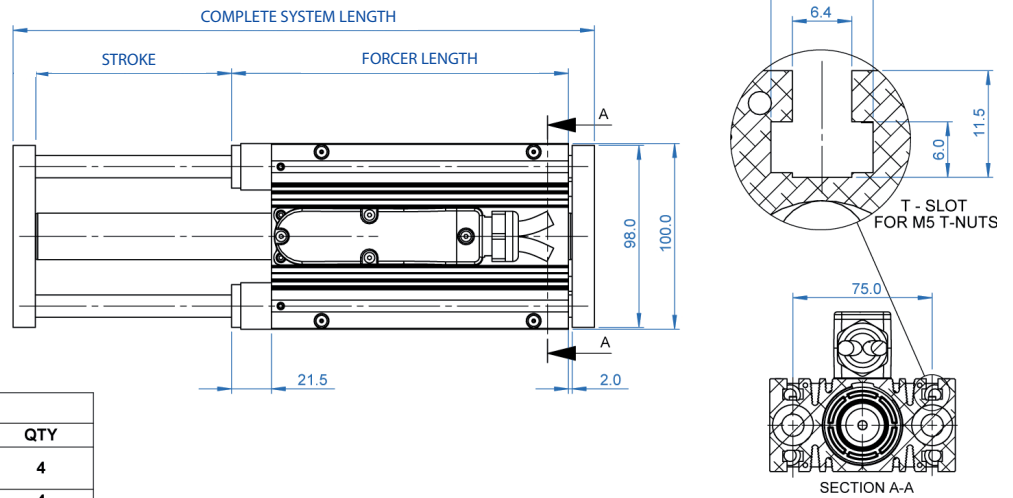

| HOLE TABLE | | |
|------------|--|-----|
| TAG | SIZE | QTY |
| A | C/B $\varnothing 6.60$ THRU $\varnothing 11.0$ $\nabla 6.5$ | 4 |
| B | M6 | 4 |

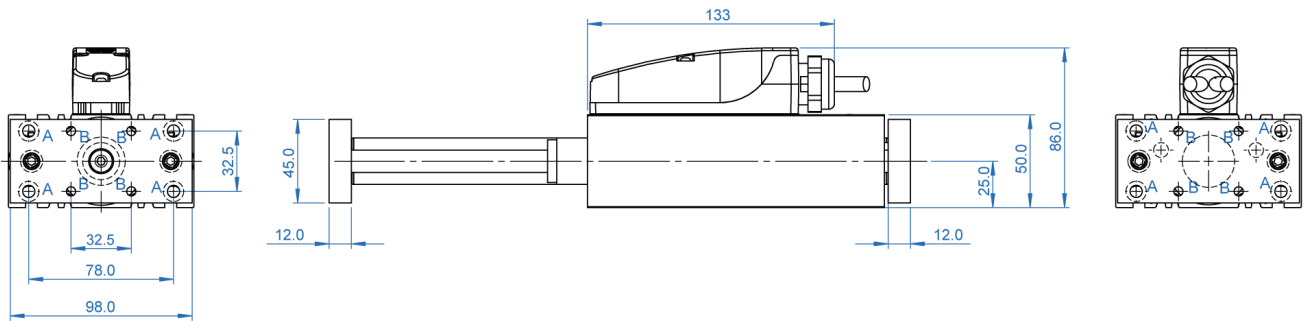

| Stroke (mm) | Complete system length (mm) | | | |
|-------------|-----------------------------|---------|---------|---------|
| | XTR2504 | XTR2506 | XTR2508 | XTR2510 |
| 28 | 236 | 287 | 339 | 390 |
| 54 | 262 | 313 | 364 | 415 |
| 79 | 287 | 339 | 390 | 441 |
| 105 | 313 | 364 | 415 | 467 |
| 131 | 339 | 390 | 441 | 492 |
| 156 | 364 | 415 | 467 | 518 |
| 182 | 390 | 441 | 492 | 544 |
| 207 | 415 | 467 | 518 | 569 |
| 233 | 441 | 492 | 544 | 595 |
| 259 | 467 | 518 | 569 | 621 |
| 284 | 492 | 544 | 595 | 646 |
| 310 | 518 | 568 | 621 | 672 |

| | Forcer length (mm) |
|---------|--------------------|
| XTR2504 | 181,5 |
| XTR2506 | 232,5 |
| XTR2508 | 283,5 |
| XTR2510 | 334,5 |

POSITION SENSOR

The position sensor outputs analogue, differential sine and cosine signals for providing position feedback. Shown below are the relationships between forcer phase back EMF and position sensor outputs for one direction of motion (as shown by arrows). It should be noted that +SIN or -SIN is always in phase with forcer phase U. For the motion shown, -SIN is in phase with forcer phase U. For motion in the opposing direction +SIN is in phase with forcer phase U.

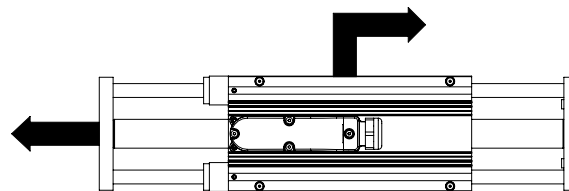
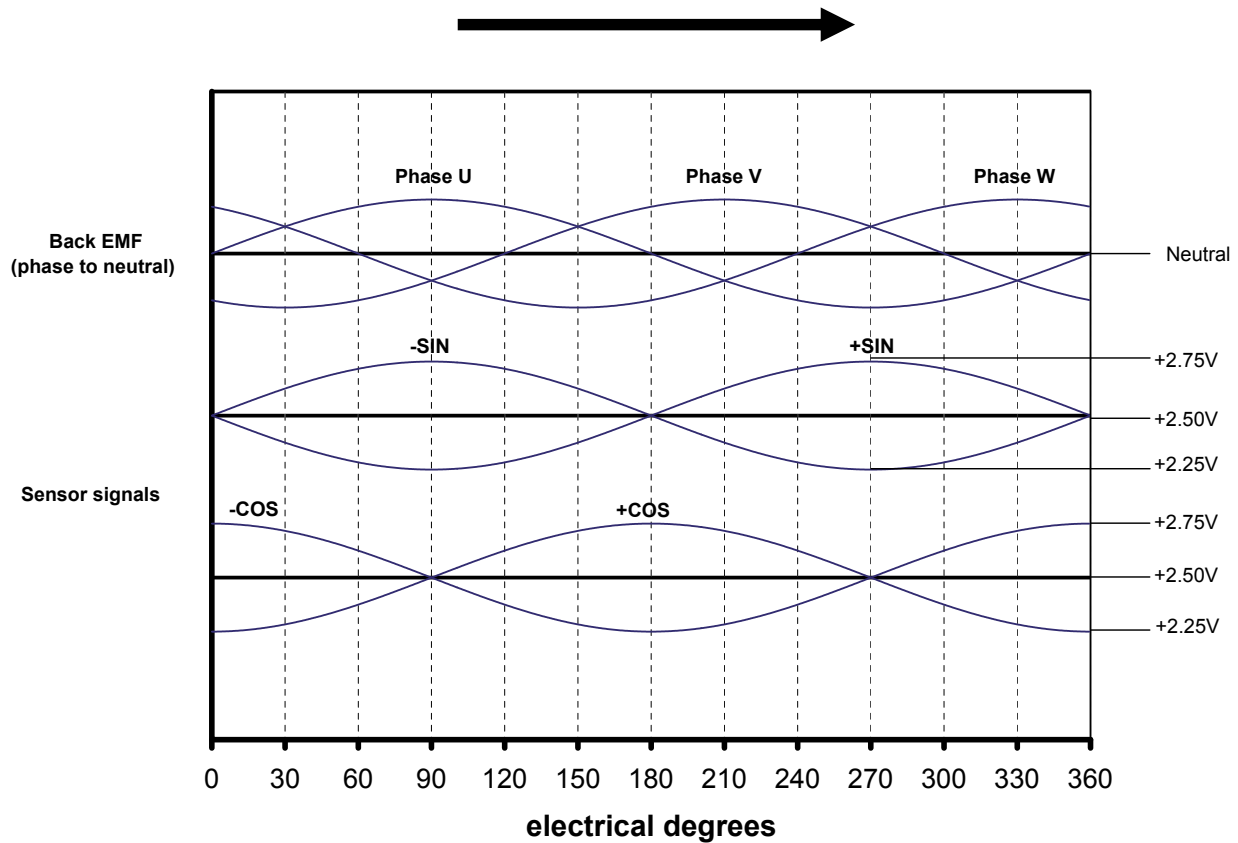

| SPECIFICATION | VALUE | units |
|--|--------------|--------|
| Output signal period | 51.2 | mm |
| Signal amplitude (between +/- signals) | 1 | Vpk-pk |
| Output current | ± 10 | mA |
| Supply voltage | 5 ± 0.25 | Vd.c. |
| Supply current (output current=0) | 15 ± 5 | mA |
| Resolution ⁽¹⁾ | 12 | micron |
| Position repeatability ⁽²⁾ | ± 12 | micron |
| Absolute accuracy ⁽³⁾ | ± 350 | micron |

Notes:

⁽¹⁾ Dependent on amplifier (indication with 12 bit resolution)

⁽²⁾ Dependent on amplifier. Under constant operating conditions. Self-heating of the forcer will cause expansion in the thrust rod during the initial warm up period. In high duty applications (corresponding to an internal forcer temperature of 80°C) a 1 metre thrust rod will expand typically by 250 microns.

⁽³⁾ Maximum error over 1 metre under constant operating conditions.

FORCER OVER TEMPERATURE SENSOR



It is strongly recommended that the forcer over-temperature sensor is connected to the drive amplifier or servo controller **at all times** in order to reduce the risk of damage to the forcer due to excessive temperatures.

Protection is provided by three positive temperature coefficient (PTC) thermistors embedded in the forcer phases. As the forcer phase temperature approaches 100°C, the PTC thermistors exhibits a sharp increase in electrical resistance. This change in resistance can be detected by circuitry within the drive amplifier or servo controller and used to reduce or disable the output of the drive amplifier in order to protect the forcer.

| SPECIFICATION | VALUE | units |
|---|-----------|-------|
| Resistance in the temperature range -20°C to + 70°C | 60 to 750 | Ohms |
| Resistance at 85°C | ≤1650 | Ohms |
| Resistance at 95°C | ≥3990 | Ohms |
| Resistance at 105°C | ≥12000 | Ohms |
| Maximum continuous voltage | 30 | Vd.c. |

FORCER ELECTRICAL CONNECTIONS

Connections are made within the termination box.

| PIN NUMBER | FUNCTION |
|------------|--------------|
| 1 | Phase U |
| 2 | Phase V |
| 3 | Phase W |
| Chassis | Earth/Screen |

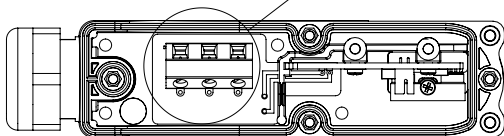
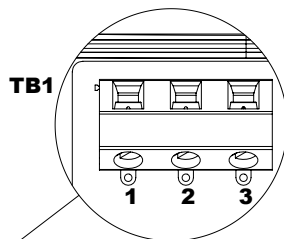

| PIN NUMBER | FUNCTION |
|------------|------------------|
| 1 | +SIN |
| 2 | -SIN |
| 3 | +COS |
| 4 | -COS |
| 5 | +5Vd.c. |
| 6 | 0V |
| 7 | +TH (Thermistor) |
| 8 | -TH (Thermistor) |

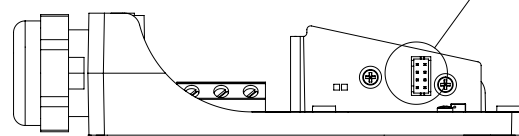
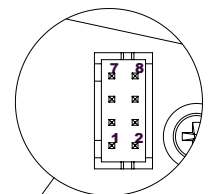

CABLE TYPE

The XTR has two separate cables providing connections for forcer power and position sensor. Cable types are available in 3 metre, 5 metre or 10 metre lengths.

Cables are suitable for continuous flex or drag chain applications.

| | POWER | SENSOR |
|---|-----------------------------|-----------------------------|
| Overall diameter (nominal) | 8.0mm | 5.8mm |
| Outer jacket material | PUR | PUR |
| Number of conductors | 4 | 4 x twisted pair |
| Size of conductors | 1.5mm ² (22 AWG) | 0.14mm ² (26AWG) |
| Screened / Unscreened | Screened | Screened |
| Minimum bending radius - flexible routing | 42mm | 42mm |
| Operating temperature - flexible routing | -15°C to +80°C | -15°C to +80°C |
| Operating temperature - fixed routing | -30°C to +80°C | -30°C to +80°C |

CABLE TERMINATION

The XTR cable is available with three termination options. **Option F** has the wire ends stripped and solder tinned ready for termination. All other options are terminated with connectors that plug directly into the desired amplifier. The connections for all options are shown below: -

| SENSOR FUNCTION | D - (XTL-S) | N - (ESR-Pollmeier) | F - (Flying leads) |
|-----------------------|---------------------------------|-----------------------------|--------------------|
| +SIN | 14 | 6 | Blue |
| -SIN | 13 | 7 | Red |
| +COS | 12 | 11 | White |
| -COS | 11 | 12 | Brown |
| +5Vd.c. | 4 | 10 | Yellow |
| 0V | 5 | 15 | Green |
| +TH (Thermistor) | 10 | 5 | Pink |
| -TH (Thermistor) | 15 | 15 | Grey |
| SCREEN | 1+ shell | Shell | SCREEN |
| Connector type | 15-way high density D | 15-way high density D | - |
| Amplifier connection | J8 | X6.2 | - |
| POWER FUNCTION | | | |
| Forcer phase U | 4 | U | Black <u>1</u> |
| Forcer phase V | 3 | V | Black <u>2</u> |
| Forcer phase W | 2 | W | Black <u>3</u> |
| Earth (forcer body) | 1 | PE | Green/Yellow |
| SCREEN | 1 | Shell | SCREEN |
| Connector type | 4-way 5mm pluggable terminal | 4-way pluggable terminal | - |
| Amplifier connection | J2 | X3 | - |

BRAKE INFORMATION (OPTIONAL)

When selecting the brake, the stroke is reduced by 60 mm.

ENVIRONMENT

The XTR is intended for use in an environment within the following conditions:

| SPECIFICATION | VALUE |
|---------------------------------|------------------|
| Operating temperature | 0°C to +40°C |
| Storage temperature | -25°C to +70°C |
| Ingress protection | IP67 |
| Altitude (above mean sea level) | 1000m |
| Overvoltage category | II |
| Pollution degree | 2 |
| EMC | light industrial |

In addition, the XTR is available with two environmental coating options. The forcer body is coated as standard with a 25 micron layer of black anodise that is suitable for general use. **Option H** has the forcer body coated with a 90 micron layer of hard natural anodise that is suitable for harsher environments. This option is available at a minimum quantity of 25 pieces per year.

ORDER CODES

Actuator

XTR25 □ □ □ - □ □ □ □ - □ - □ □ □ □ - □ □

Forcer

04, 06, 08, 10

Winding

S - Series

Stroke

028, 054, 079, 105, 131, 156
182, 207, 233, 259, 284, 310

Stroke in mm

Bearing

B - Bush
P - Polymer

Environment

S - Standard
H - Harsh (on request)

Brake

blank - no brake
BR - Brake

Cable Termination

D - Xenus (XTL-S)
F - Flying leads
N - ESR Pollmeier

Cable Length

03 - 3 m
05 - 5 m
10 - 10 m

Cable Type

R - Robotic

Features

- » Vertical Holding Brake
- » Holding Force > 200N
- » 24 Volt DC supply
- » Fail Safe Operation



The OEM advantage

- » High holding force in small package
- » Reliable and cost-effective
- » No maintenance or adjustment

OVERVIEW

The ServoTube brake provides a solution to power down parking of vertical axes and controlled deceleration of axes during power fail conditions. The brake is a bolt-on addition to any XTR25 forcer and is IP67 rated. It is a unidirectional self-jamming design, which uses the motor's motion to create the necessary forces for braking the system. To minimize size, the brake is designed to be reset by the motor itself. Once reset, it is held off by a compact 24V electromagnet. The motor is then free to operate as normal until the release of power to the brake.

OPERATION

From power-on, the brake must be released before normal operation of the motor.

Release:

1. Apply power to the forcer and drive the thrust rod UP by applying sufficient force to overcome the braking action (70-80N).
2. Continue driving UP until the STOP on the thrust rod activates the BRAKE RELEASE. Activation can be detected by the controller when velocity=0 or there is no change in position.
3. Apply 24V to brake solenoid.
4. Wait 100ms.
5. The brake will now hold off and the forcer can operate as normal.

Activate:

1. Remove 24V from the brake solenoid. The thrust rod will fall a very short distance before the brake activates.
2. Wait 100ms.
3. Disable the servo to remove power from the forcer.

SPECIFICATIONS

| Angabe | Wert |
|---------------------------|----------------------------|
| Environment | |
| Operating temperature | 0°C ... +40°C |
| Humidity (relative) | 0 ... 95% (non-condensing) |
| Electrical data | |
| Power requirement | 24VDC +/- 10% |
| Power dissipation | 4 W |
| Brake | |
| Holding force | >200 N |
| Reset force (using motor) | 50 ... 70 N |
| Mass | 0,26 kg |

OUTLINE DRAWINGS

SBR25

