

# TNP4

series



---

## Product Segments

### • Care Motion

Maximum available buttons	15
Color	black or grey
Protection class	IP54 or IP66
Option	back cover
Control up to 7 channels in connection with TC8	
Mounted into side rail or foot board directly	
Can be used as lock-out box	

## Drawing

Standard Dimension  
(mm)

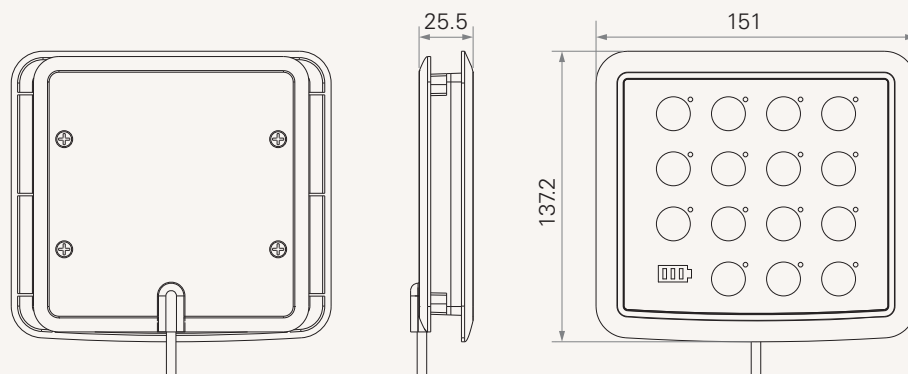

Dimension with Cable length

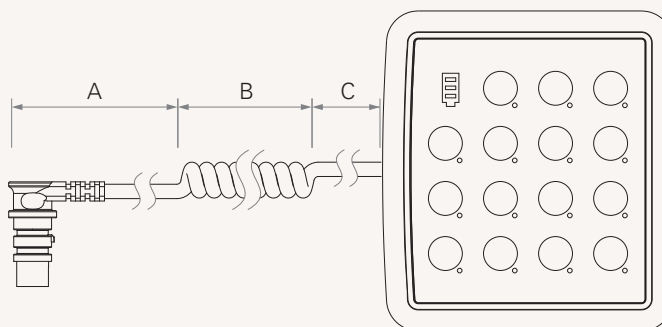

### Cable Length (mm)

CODE	A	B	C
1	1000	300	200
2	1200	300	300
3	1400	300	400
4	2400	0	0
5	0	600	0
6	1000	200	200
A	Customized length		

### Terms of Use

The user is responsible for determining the suitability of TiMOTION products for a specific application.







Due to continuous development in order to improve our products, TiMOTION products are subject to frequent modifications and changes without prior notice.

TiMOTION reserves the right to discontinue the sale of any products displayed on its website or listed in its catalogue or other written materials drawn up by TiMOTION.

# TNP4 Ordering Key

## TNP4

Version: 20130510-C

	<b>Plug</b>	1 = DIN 8pin, 90°, for TC2/TC3 2 = RJ 10pin, 90°, for TC1/TC8/TC10 4 = DIN 8pin, 180°, for extension cable	5 = RJ 10pin, 180°, for TC6/TC9/extension cable A = Customized	
	<b>Color</b>	1 = Black	2 = Grey (Pantone 428C)	
	<b>IP Protection</b>	1 = Without	2= IP54	3 = IP66
	<b>Back Cover</b>	0 = Without	1 = With	
	<b>Key Definition</b>	A = Customized		
	<b>Cable Length</b>	1~6 = See appendix	A = Customized	