

1-STEP-DRIVE-5A-48V

Stepper Motor Module for the SIMATIC ET 200® S



1-STEP-DRIVE-5A-48V

for SIMATIC ET 200[®]S

**Module Description
and Commissioning**

TRANSLATION OF THE GERMAN ORIGINAL MANUAL

1-STEP-DRIVE Module

© 2015

All rights with:

Phytron GmbH

Industriestraße 12

82194 Gröbenzell, Germany

Tel.: +49(0)8142/503-0

Fax: +49(0)8142/503-190

In this manual you will find the feature descriptions and specifications of the ET 200[®]S module for positioning of a stepper motor: 1-STEP-DRIVE-5A-48V.

This manual is supplementary to the ET 200[®]S Distributed I/O System operating instructions.

The ET 200[®]S Distributed I/O System

(<http://support.automation.siemens.com/WW/view/en/1144348>) operating instructions provide comprehensive information pertaining to the hardware configuration, installation, wiring, commissioning, diagnostics and technical specifications of the ET 200[®]S distributed I/O system.

Every possible care has been taken to ensure the accuracy of this technical manual. All information contained in this manual is correct to the best of our knowledge and belief but cannot be guaranteed. Furthermore we reserve the right to make improvements and enhancements to the manual and / or the devices described herein without prior notification.

We appreciate suggestions and criticisms for further improvement.

Email address: doku@phytron.de

Questions about the use of the product described in the manual that you cannot find answered here, please contact your representative of Phytron (<http://www.phytron.de/>) in your local agencies.

Contents

1	1-STEP-DRIVE-5A-48V	5	6.3.1 Task Example.....	39
1.1	Short Overview.....	5	6.3.2 Implementation of the Program Steps	39
1.2	Overview of the Data Interfaces	7	6.3.3 Program Test.....	40
1.3	Directives and Standards	8	6.3.4 Program Result.....	40
1.4	Declaration of Conformity	9	6.3.5 Traversing Job, Parameter Changing and Troubleshooting.....	41
2	To Consider Before Installation	10	7 Data Transfer in Operation.....	44
2.1	Qualified Personnel	10	7.1 Control Interface.....	45
2.2	Safety Instructions.....	10	7.1.1 Assignment.....	45
2.3	Ambient Conditions	12	7.1.2 Notes for the Control Bits	47
3	Safety Concept.....	13	7.2 Feedback Interface.....	49
3.1	Safety Measures	13	7.2.1 Assignment.....	49
3.1.1	EMC Measures.....	15	7.2.2 Notes on the Feedback Bits	50
3.2	Shielding.....	15	7.2.3 Error numbers in the Feedback Interface	52
4	Technical Data	16	7.3 Data Set Transfer	53
4.1	Mechanical Data.....	16	7.3.1 Data Set 80: Write Command / Change Parameters	53
4.2	Features	17	7.3.2 Data set 81: Read Power Stage Status and Parameters.....	55
5	Installation	21	8 Principles of Positioning	56
5.1	Sizing of the Power Supply	22	8.1 Traversing Curve of the 1-STEP-DRIVE	56
5.2	Mechanical Installation	23	8.2 Setting the Base Frequency	60
5.3	Derating.....	24	8.3 Functions of the 1-STEP-DRIVE	62
5.4	Temperature Behavior at Typical Application Conditions.....	27	8.4 Positioning of the Stepper Motor.....	62
5.5	Electrical Installation.....	28	8.4.1 Search for Reference	62
5.5.1	Motor Connection	29	8.4.2 Sequence of Execution of the Search for Reference.....	64
5.6	Wiring Schemes	30	8.4.3 Set Home Position.....	66
5.7	Diagnostics by the LEDs	31	8.4.4 Relative Incremental Mode (Relative Positioning).....	67
6	Commissioning.....	32	8.4.5 Absolute Incremental Mode (Absolute Positioning).....	68
6.1	Configuration of the Module via STEP®	732	8.4.6 Velocity Control Mode	69
6.2	Parameterizing of the Module via STEP®	733	8.4.7 Hold Traversing Job	71
6.2.1	Examples for a Parameter selection.	33		
6.2.2	Parameter list	35		
6.2.3	Causes of Parameter Setting Errors.	38		
6.3	Programming of the ET 200®S with the SIMATIC Manager (Example)	39		

1-STEP-DRIVE Module

8.4.8 Axis Type and Traversing Range	72	8.5.7 Overdrive	86
8.4.9 Pulse Enable	74	8.5.8 Basic Position	87
8.4.10 Changing Positioning Parameters during Operation	75	9 ESD Protective Measures	88
8.4.11 Behavior of the Digital Inputs	76	10 Disclaimer	88
8.4.12 Behavior at CPU-Master-STOP	77	11 Warranty and Trade Marks	88
8.5 Functions of the Integrated Power Stage	78	12 Appendix: Parameterization and Data Sets	89
8.5.1 Phase Currents (Run, Stop, Boost Current)	78	12.1 Parameters in HW-Konfig (16-Byte-prm file)	89
8.5.2 Preferential Direction	79	12.2 Assignment of the Control Interface	91
8.5.3 Chopper Frequency	80	12.3 Assignment of the Feedback Interface	93
8.5.4 ODIS Behavior	80	12.4 Data Set 80	94
8.5.5 Step Resolution	81	12.5 Data Set 81	95
8.5.6 Current Delay Time	85	13 Glossary	96
		14 Index	101

1 1-STEP-DRIVE-5A-48V

1.1 Short Overview



Fig. 1: 1-STEP-DRIVE Module

1-STEP-DRIVE-5A-48V is a stepper motor controller with integrated power stage. It is specially developed for application in the decentralized SIMATIC ET 200[®]S peripheral system.

2 phase stepper motors in the 200 W power range up to 5 A_{PEAK} with a supply voltage from 24 to 48 V_{DC} can be controlled by this module. Beside the high precision positioning up to 1/512 micro step in operating/incremental mode, the 1-STEP-DRIVE can be applied in velocity control mode. Two parameterizable digital inputs are available for limit or reference switches, too.

The most important characteristic features of the 1-STEP-DRIVE:

- 2 phase stepper motor controller with integrated power stage for SIMATIC ET 200[®]S
- 200W power range up to 5A_{PEAK} at 24-48V_{DC}
- Up to 1/512 micro step
- Maximum starting frequency 510 kHz

1-STEP-DRIVE Module

- Operating modes:
 - + Reference point approach
 - + Relative incremental mode (relative positioning)
 - + Absolute incremental mode (absolute positioning)
 - + Velocity control mode
 - + Set home position
- Support of linear and modulo axes (rotary axes)
- Function and active level of the IN0 and IN1 digital inputs can be configured
- Type of the feedback value can be set in the feedback interface (residual distance, position or frequency)
- Power stage parameter setting after starting the system and during operation: e.g.: run, stop, boost current, step resolution, current delay time, etc.
- Online power stage diagnostics
- STEP[®]7 programming

1.2 Overview of the Data Interfaces

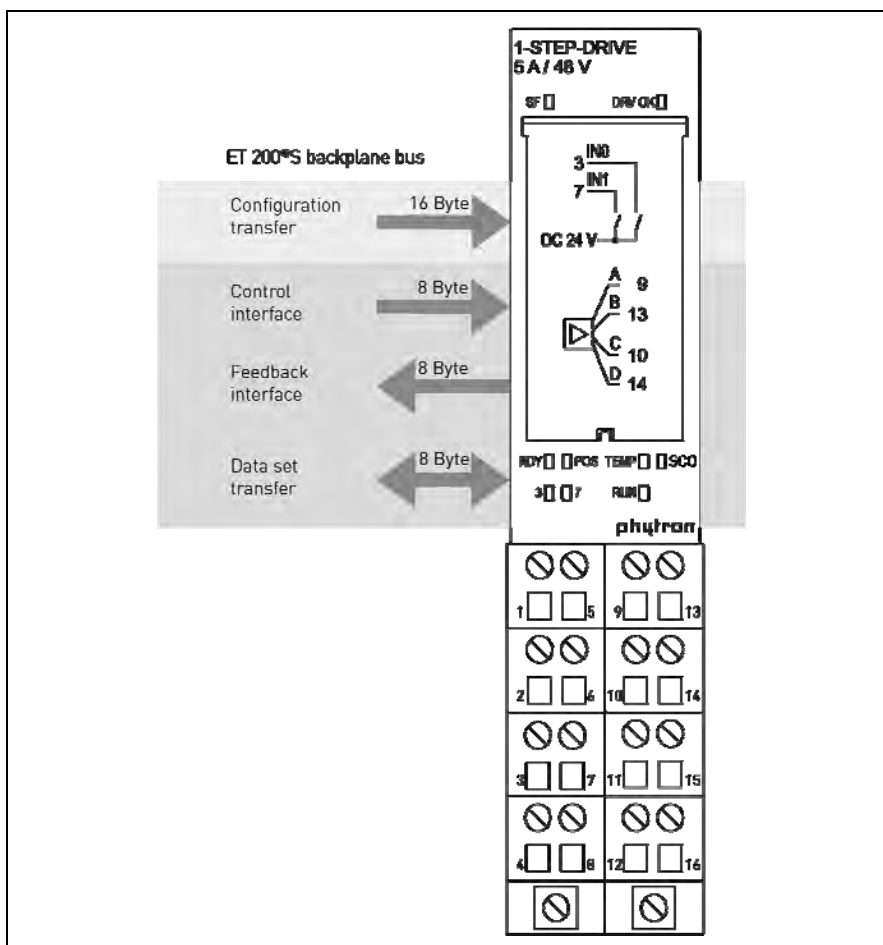

Fig. 2: Data bus

Configuration transfer: Configuration of the module with STEP[®]7: all 1-STEP-DRIVE parameters can be set by mouse click and transmitted (16 Byte).

See chap. 6.

Control / Feedback interface: So called parameter assignment jobs can synchronize with the clock of the control and feedback interface to be transmitted and status be read (e.g.: base frequency F_b , multiplier, ramp definition ...).

See chap. 7.1 and 7.2.

Data set transfer: If there is no transfer instruction, the complete parameter set of the power stage can be transferred from the user program into the 1-STEP-DRIVE module (e.g.: run current, stop current, step resolution, etc.). Reading of the data set and status inquiry are independent of the transfer job, writing is only possible at motor standstill.

See chap. 7.3.

1-STEP-DRIVE Module

1.3 Directives and Standards

CE Mark	With the declaration of conformity and the CE Mark on the product the manufacturer certifies that the product complies with the requirements of the relevant EC directives. The unit, described here, can be used anywhere in the world.
EC Machinery Directive	The drive system, described here, is not a machine in the sense of the EC Machinery Directive (2006/42/EC), but a component of a machine for installation. They have no functional moving parts, but they can be part of a machine or equipment. The conformity of the complete system in accordance with the machine guideline is to be certified by the manufacturer with the CE marking.
EC EMC Directive	<p>The EC Directives on electromagnetic compatibility (89/336/EEC) applies to products that can cause electromagnetic interference or whose operation can be impaired by such interference.</p> <p>The power stage's compliance with the EMC Directive cannot be assessed until it has been installed into a machine or installation. The instructions provided in "Installation" must be complied with to guarantee that the ZMX⁺ is EMC compliant when fitted in the machine or installation and before use of the device is permitted.</p>
Standards for safe operation	EN 60204-1: 1998-11: Electrical equipment of machines, degree of pollution 2 must be observed EN 60529: IP Degree of protection
Standards for observing the EMC limit values	EN 61000-6-2:2005 / EN 61000-6-4: EMC Immunity for industrial environments
Standards for measuring methods of observing EMC limit values	EN 55011 class B: Noise field and voltage measuring EN 61000-4-2...6,11 Emission standard test
Standards for environmental tests	EN 60068-2-6: Vibration, sinusoidal EN 60068-2-27/29: Vibration and shock resistance

1.4 Declaration of Conformity



Declaration of Conformity according to EC directive 2004/108/EC (EMC-Directive)

Name and address of the manufacturer:

Phytron-Elektronik GmbH,
Industriestr. 12
82194 Gröbenzell

We declare that the following product is in conformity with the EC Directives 2004/108/EC relating to EMC.

Id.-No, Product denomination

10012726, 1-STEP-DRIVE-5A-48V FOR SIMATIC ET200S

All serial numbers.

Applied harmonized standards

- EN 61000-6-2: 2005-08 Electromagnetic compatibility (EMC) - Immunity for industrial environments
- EN 61000-6-4: 2007-01 Electromagnetic compatibility (EMC) - Emission standard for industrial environments

Gröbenzell, 2010-12-08

Johannes Schmid
Technical Director

AP QS-0672-2
CE 7020 Rev. 1

Phytron-Elektronik GmbH

Industriestr. 12 - 82194 Gröbenzell
Postfach 1255 - 82180 Gröbenzell
T +49-8142-503-0 F +49-8142-503-190
E info@phytron.de W www.phytron.de

Geschäftsführung Birgit Hartmann
Reg.-Gericht München - HRB 44428
USt-Ident-Nr. DE 128 242 722
Steuernummer 117-135-10027

Genossenschaftsbank - Kto. 96610 - BLZ 70169444
IBAN DE6770169640000096610 - BIC GENODEF1M07
Sparkasse Fürstenfeldbruck - Kto. 1801265 - BLZ 70053070
Oberbank München - Kto. 1041021021 - BLZ 70120700
Volksbank Fürstenfeldbruck - Kto. 712531 - BLZ 70163370
Postbank München - Kto. 0286001800 - BLZ 70010080

1-STEP-DRIVE Module

2 To Consider Before Installation



Read this manual very carefully before installing and operating the 1-STEP-DRIVE.

Observe the safety instructions in the following chapter!

2.1 Qualified Personnel

Design, installation and operation of systems using the ZMX⁺ may only be performed by qualified and trained personnel.

These persons should be able to recognize and handle risks emerging from electrical, mechanical or electronic system parts.

The qualified personnel must know the content of this manual and be able to understand all documents belonging to the product. Safety instructions are to be planned.

The trained personnel must know all valid standards, regulations and rules for the accident prevention of accidents, which are necessary for working with the product.



WARNING

Without proper training and qualifications damage to devices and injury might result!

2.2 Safety Instructions

i The 1-STEP-DRIVE is designed for operating in a SIMATIC ET 200[®]S system. An installation is allowed only if the requirement of the EC Machine Directive and EMC are conformed with. See chap. 1.2 and 1.3.

i This product is used as a part of a complete system, therefore risk evaluations concerning the specific application must be made before using the product. Safety measures have to be taken according to the results and be verified.

Personnel safety must be ensured by the concept of this complete system (e.g. machine concept).

i In any application the reliability of operation of the software products can be impaired by adverse factors, e.g. differences in electrical power supply or, computer hardware malfunctions.

To avoid damage by system failures the user must take appropriate safety measures, including back-up or shutdown mechanism.

i Malfunctions are possible while programming the instruction codes – e.g. sudden running of a connected motor, braking etc.
Please test the program flow step by step!

i Each end user system is customized and differs from the testing platform.
Therefore the user or application designer is responsible for verifying and validating the suitability of the application.

WARNING



Injury or damage by overvoltage!

Operate the module only in accordance with the protective measures in chap. 3.

ATTENTION



Risk of damage by incorrect motor current setting!

The 1-STEP-DRIVE is set to a default current on delivery!
The motor current must be set to the designated value before installation (see data of the motor).

DANGER



Danger of electrical arcing!

Always switch off the supply voltage before connecting or disconnecting any wires or connectors at the power stage.
Do not unplug the connector while powered!

DANGER



Danger of electrical arcing!

Do not unplug the connector while powered!
Load voltage must be powered off by external switches or by a removable fuselink!

DANGER



Danger of electric shock!

Up to 3 minutes after turning off the supply voltage, dangerous voltages may still exist at the connectors or on the board.

i Energizing the inputs DEACTIVATION or RESET or in ODIS (see chap. 8.5.4) behavior is not safe in the case of an emergency stop.
The voltage supply has to be interrupted for safe isolation of the drive.

1-STEP-DRIVE Module

2.3 Ambient Conditions

Operating temperature	0°C to +60°C
Storage and transport temperatures	- 40°C to +70°C
Relative humidity	95 % max. no dew
Degree of pollution	Level 2
Protection class	IP 20
Vibration / Shock protection	acc. to EN 60068-2-6 acc. to EN 60068-2-27/29
EMC immunity EMC emission	acc. to EN 61000-6-2 acc. to EN 61000-6-4
Approval	CE

3 Safety Concept

3.1 Safety Measures

The following measures are vital to the safety of the system. Carry out the safety measures with particular care and adapt them to meet the requirements of the system.



WARNING

Safety operating modes such as SafeTorqueOff (STO) from IEC61508-2 cannot be implemented directly!



WARNING

To prevent personal injury and damage to equipment please observe the following points:

- Install an emergency stop system in keeping with current technical standards (for example, European norms EN 60204, EN 418, etc.).
- Make sure that no one has access to areas of the system with moving parts.
- Install, for example, hardware limit switches for the end positions of the axes that switch off the power control system directly.
- Install devices and take steps to protect motors and power electronics.

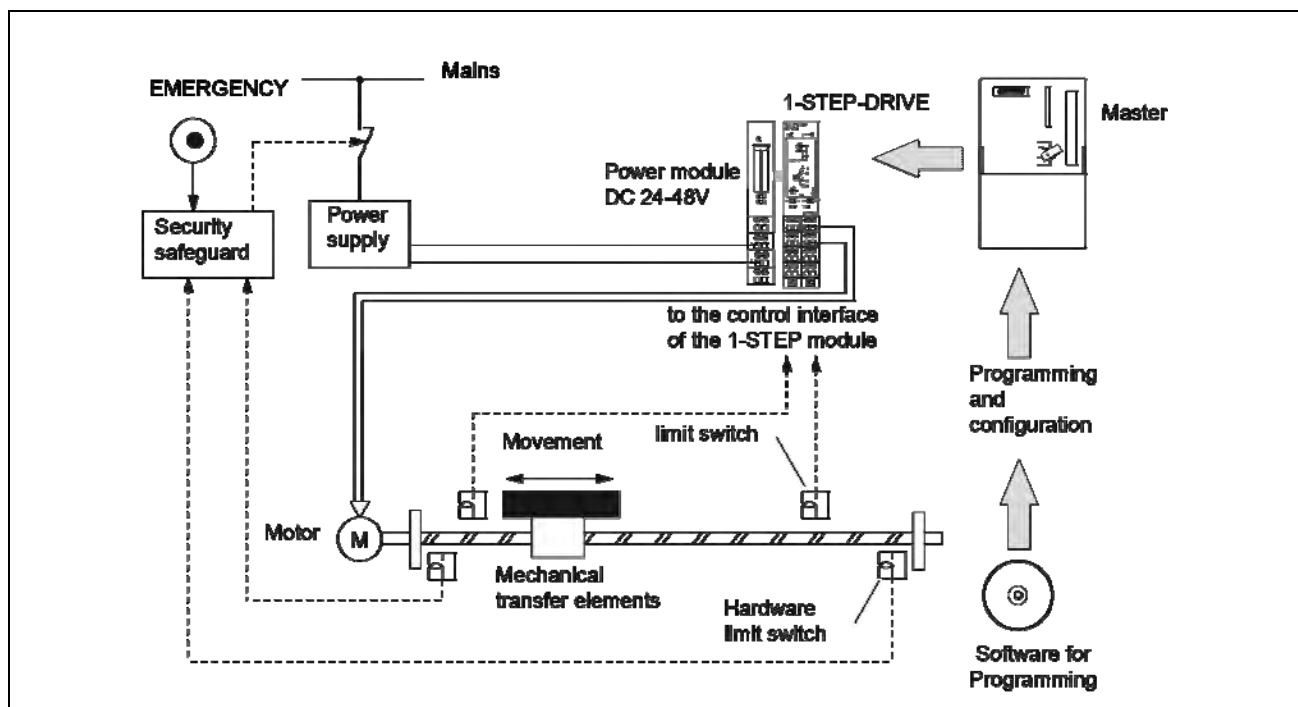

Fig. 3: Design of a positioning system with a stepper motor

1-STEP-DRIVE Module

In order to protect the protection circuit from overvoltage and transient suppression from atmospheric discharges (lightning), the “Blitzduktor BVT KKS ALD 75” (Dehn company) surge arrester is recommended:

Nominal voltage 70 V, nominal current 12 A

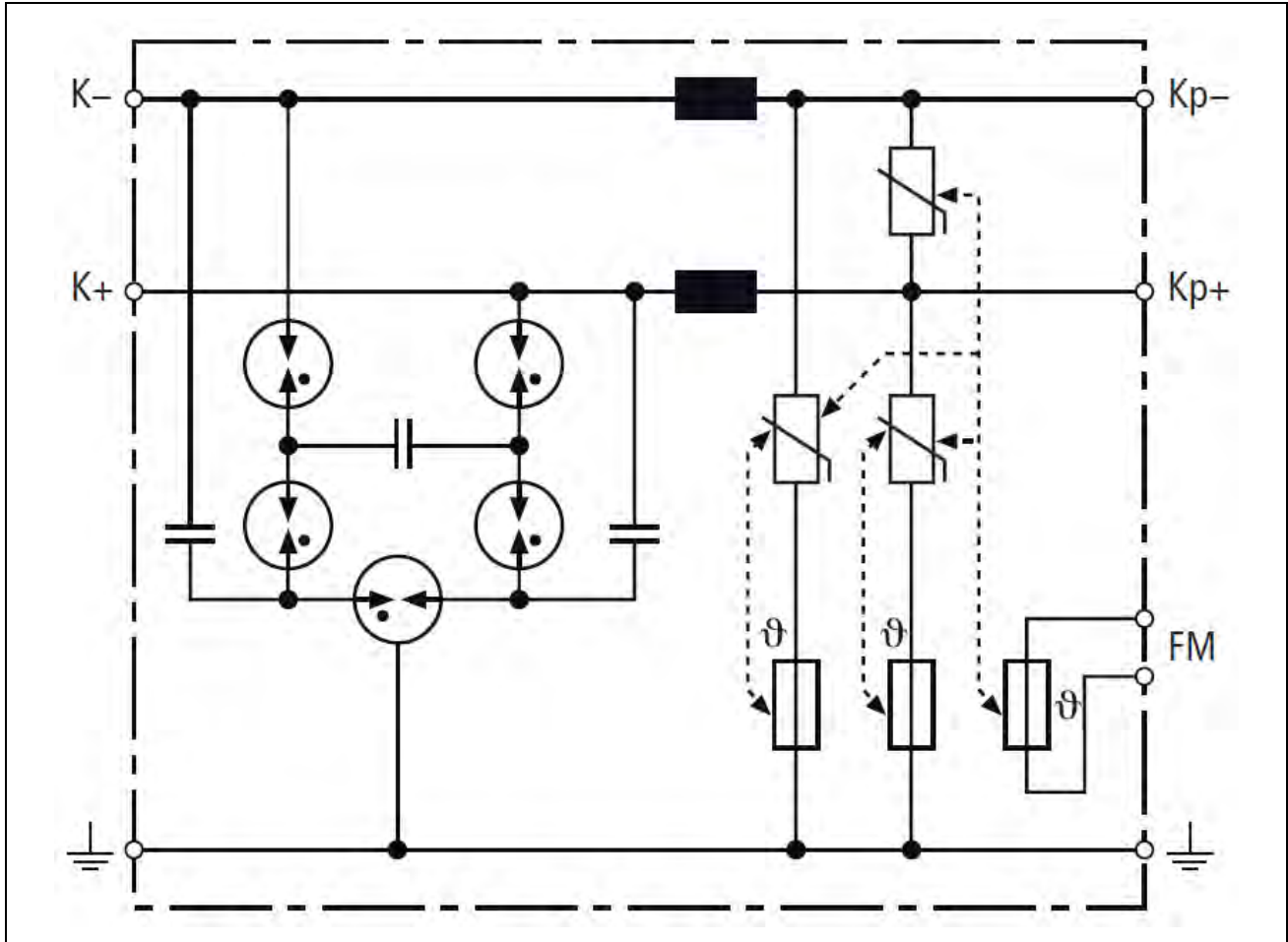

Fig. 4: Combination arrester for protection of the rectifier in the protection circuit

3.1.1 EMC Measures

Preset for EMC: Motor cable

The motor cable is a source of interference and must be positioned carefully.

Use the cables recommended by Phytron. They are tested for EMC safety and are suitable for movement.

The motor and the encoder cable of the drive system must be connected at the terminal module and the motor with low impedance.

- Connect the motor cables without interruption (do not use switches) from the motor to the device. If a cable must be interrupted, use shielded connections and metal housings to avoid interferences.
- Lay the motor cable at a distance of at least 20 cm from the signal cables. If they are laid closer together, motor cable and signal wiring must be shielded and grounded.
- Use potential equalization cables with suitable cross section when the cables are long.

Potential equalization cables

Connect the shielding on all sides for protection from interference.

The difference of potential can cause incorrect currents on the shielding and must be avoided by potential equalization cables.



The 1-STEP-DRIVE power stage must be operated with protective measure PELV/SELV.

3.2 Shielding

To avoid interference affecting the wires and instruments installed close to the drive system, we recommend the use of shielded cables.

The shield must be supported at both ends. Use the shield contact element (order number: 6ES7 390-5AA00-0AA0).

See chap. 4.9 in the *ET 200[®]S Distributed I/O System* manual for mounting the shield contact element.

1-STEP-DRIVE Module

4 Technical Data

4.1 Mechanical Data

Type	SIMATIC ET 200 [®] S plastic housing
Dimensions	30 x 81 x 50 mm (W x H x D)
Weight	80 g
Mounting	Pluggable in SIMATIC ET 200 [®] S terminal modules
Mounting position	Optional (power loss see chap. 5.2)

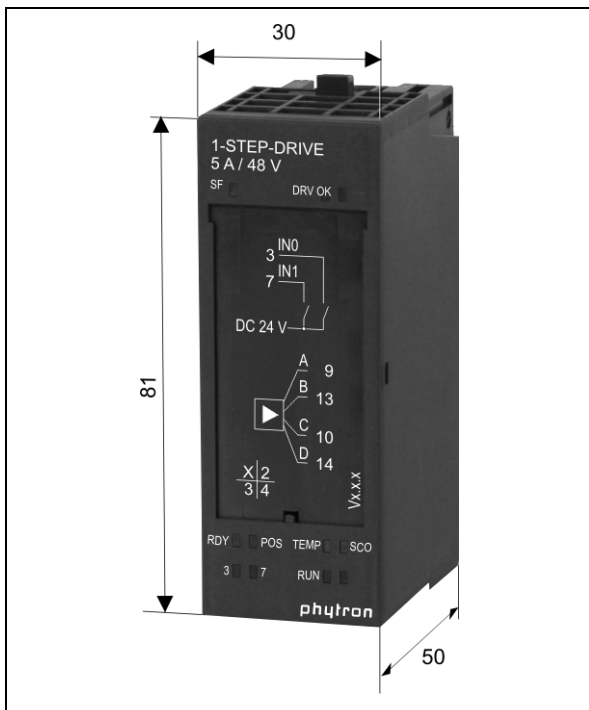

Fig. 5: Dimensions

4.2 Features

Features	
Stepper motors	Suitable for bipolar control of 2 phase stepper motors with 4, (6) or 8 lead wiring
Superior main station	SIMATIC ET 200®S
Power supply	24 to 48 V _{DC} Nominal voltage: 48 V _{DC}
Phase current	5 A _{PEAK}
Motor current adjustment	20 mA increments
Step resolutions	Full step, half step, 1/2.5, 1/4, 1/5, 1/8, 1/10, 1/16, 1/20, 1/32, 1/64, 1/128, 1/256, 1/512 micro step
Maximum step frequency	510,000 steps/sec
Physical resolution	Approx. 102,400 positions per revolution (0.0035°/step). An encoder with a counter should be considered for very fine positioning.
Chopper frequency	18, 20, 22 or 25 kHz selectable Patented Phytron chopper technology for a minimal heat loss in the motor and smooth rotation
Current consumption (max.)	3 A _{DC} at 5 A _{PEAK}
Mechanical output power	Up to the 200 W range
Nominal power of the motor voltage supply	150 W
Cable length - motor	Shielded: 50 m max.
Cable length - digital inputs	Shielded: 100 m max.

1-STEP-DRIVE Module

Diagnostic LEDs	<ul style="list-style-type: none"> • SF (group error) • DRV OK (power stage ready) • RDY (module ready) • POS (traversing job) • 3 (IN0 digital input active) • 7 (IN1 digital input active) • TEMP (over temperature > 85°C) • SCO (over current > 10 A) • RUN (Motor is running)
Operating modes of the controller	<ul style="list-style-type: none"> • Relative Positioning • Move to a reference point • Absolute Positioning • Revolution mode • Reference setting
Security modes	Security modes, such as e.g. Safe Torque Off (STO) from IEC 61508-2 are not directly compatible
Mechanism of the communication via backplane bus	Synchronous: control interface, feedback interface Asynchronous – PLC in STOP mode: Base parameterizing Asynchronous – PLC in RUN mode: Data set transfer
Support of linear and modulo axes (rotary axes)	yes
Hardware error detection	<ul style="list-style-type: none"> • Over current, > 10 A spike at the power stage • Over temperature at the power stage $T > 85\text{ °C}$
Refresh rate	2 ms

Interfaces	
Analog outputs	A, B, C, D for a 2 phase stepper motor
Digital inputs	<p>2 configurable digital inputs IN0 and IN1: 0 signal: -30 to 5 V with 2 mA max. (quiescent current) 1 signal: 11 to 30 V with 9 mA typical Input delay: 4 ms</p> <p>IN0: External stop Limit switch towards forward / reverse External release of momentum</p> <p>IN1: Reference switch and also limit switches towards forwards / reverse Limit switch configurable to open / close</p>
Backplane bus and module supply	Backplane bus of the ET 200 [®] S Module supply via ET 200 [®] S power module
Communication and Programming	
Programming	via STEP [®] 7
Control interface (synchronous)	<p>Parameter assignments:</p> <ul style="list-style-type: none"> • Base frequency F_b • Multiplier i (ramp) • Multiplier n (start-stop) <p>Positioning:</p> <ul style="list-style-type: none"> • Move to a reference point • Set home position • Relative incremental mode (relative positioning) • Absolute incremental mode (absolute positioning) • Revolution mode • Reference setting

1-STEP-DRIVE Module

<p>Feedback interface (synchronous)</p>	<p>Configurable:</p> <ul style="list-style-type: none"> • Residual distance • Absolute Positioning • Velocity <p>Also included in the feedback:</p> <ul style="list-style-type: none"> • Position reached • Parameterization error • Power stage error • Limit switch causes a stop
<p>Data set transfer to the 1-STEP-DRIVE (asynchronous while CPU RUN)</p>	<p>Parameterizing the 1-STEP-DRIVE power stage:</p> <ul style="list-style-type: none"> • Step resolution (1/1, 1/2,...1/512) • Preferred direction of rotation • Run current (20 mA increments) • Stop current(20 mA increments) • Boost current(20 mA increments) • Current delay time 1...1000 ms • Chopper frequency 18...25 kHz • Switching frequency overdrive 1... 40 kHz • ODIS behavior
<p>Data set transfer to the 1-STEP-DRIVE (asynchronous)</p>	<p>Diagnostics</p> <p>Feedback of the following driver parameters(asynchronous) to the main station</p> <ul style="list-style-type: none"> • Power stage parameters • Home position • Error (short circuit, over temperature, parameterizing error)

5 Installation

Following modules/components are necessary for the connection of the 1-STEP-DRIVE:

- ET 200[®]S station
- 24–48 V_{DC} supply
- Applicable terminal modules:

Terminal modules	Order number	Terminals
TM-E30S46-A1	6ES7193-4CF40-0AA0	screw with AUX1
TM-E30C46-A1	6ES7193-4CF50-0AA0	spring with AUX1
TM-E30S44-01	6ES7193-4CG20-0AA0	screw without AUX1
TM-E30C44-01	6ES7193-4CG30-0AA0	spring without AUX1

- Applicable power modules:

Power module for ET 200 [®] S	Order number
DC 24V-48V with diagnostics	6ES7138-4CA50-0AB0 SIMATIC DP
DC 24V-48V, AC 24-230V with diagnostic and protection	6ES7138-4CB11-0AB0 SIMATIC DP

- 1-STEP-DRIVE-5A–48V
- 2 phase stepper motor up to 5 A_{PEAK}
- Shield contact element
- The necessary wiring material

1-STEP-DRIVE Module

5.1 Sizing of the Power Supply

The voltage of the supply unit (24 V_{DC} or 48 V_{DC}) depends on the motor speed during operation. For low velocity (about < 300 rev/min) but high torque or if only low torque is necessary at higher velocity (> 300 rev/min), a 24 V_{DC} supply voltage is often sufficient. Refer to the technical data of the stepper motor manufacturer for information about the required performance with 24 V. These usually indicate torque characteristics dependent on the supply voltage.

If higher numbers of revolutions must be achieved, we recommend to supply the 1-STEP-DRIVE module with 48 V_{DC}.

i Make sure that a separate 48 V_{DC} power module in front of the 1-STEP-DRIVE is integrated and a 24 V_{DC} power module behind the power stage module should further modules need 24 V! Otherwise, damage the subsequent modules is likely by excessive supply voltages!

Generally the necessary power of the supply voltage is calculated by rules of thumb:

$$P_{\text{SUPPLY}} = 2 \times P_{\text{MECHANICAL}} \text{ (for speeds } < 300 \text{ rev/min)}$$

$$P_{\text{SUPPLY}} = 3 \times P_{\text{MECHANICAL}} \text{ (for speeds } > 300 \text{ rev/min)}$$

If there is no power supply unit in the direct vicinity of the power module, Phytron recommends the use of the following ferrites:

- i**
- Ferrite bead of Würth Elektronik no. 742 772 90 with 4 windings on the +/-48 V_{DC} cable (both cables enclosed) and
 - additionally a ferrite bead with 3 windings (only on the +48 V_{DC} cable)

Alternatively, the snap ferrite of Würth Elektronik no. 742 727 22 is recommended.

5.2 Mechanical Installation

See chap. 4 of the *ET 200[®]S Distributed I/O System* manual.

The 24...48 V_{DC} power module which is connected **in front of** the 1-STEP-DRIVE must be supplied:

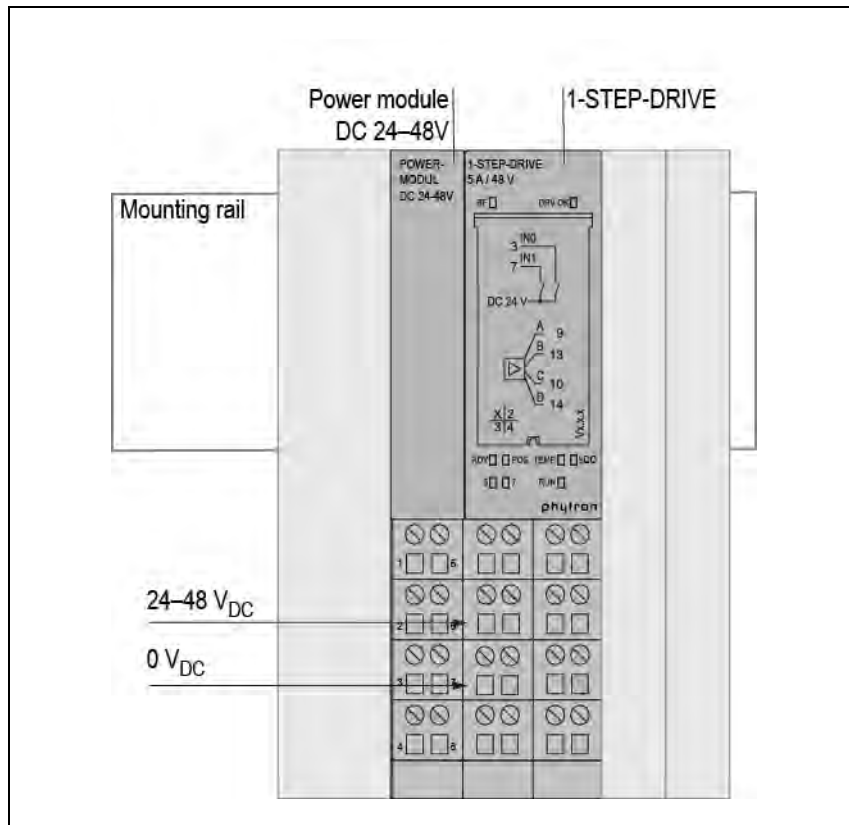

Fig. 6: Connection of the DC24-48V power module

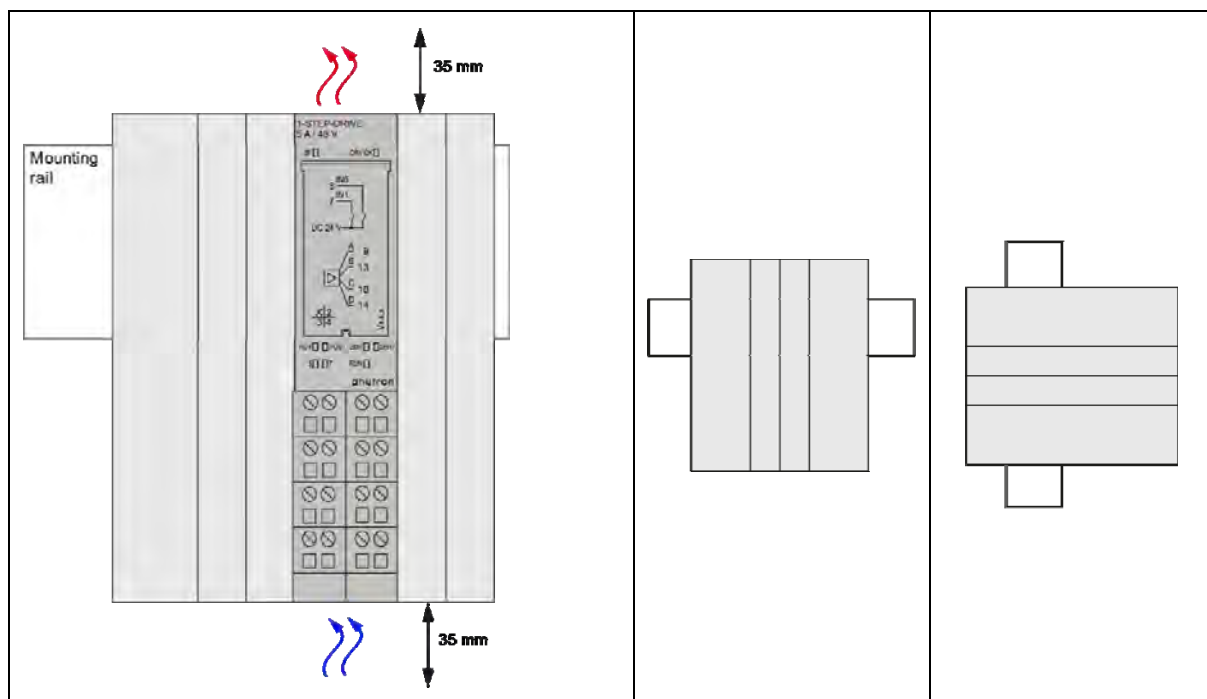

Fig. 7: Mounting position horizontal or vertical

1-STEP-DRIVE Module



Damage or destruction of the module!

Keep the recommended distance to other components to allow a sufficient air circulation..

5.3 Derating

The following derating curves describe the relationship between phase current, ambient temperature and duty cycle (DC).

The derating curves were recorded with the following parameters that characterize the use of the 1-STEP-DRIVE in worst case:

- No air circulation at the module or through the module.
- Operating with those maximum motor speeds at which the preset current is still impressed completely into the motor. This operating point produces the maximum heating of the 1-STEP-DRIVE.
- The half run current is impressed as stop current in the DC-induced pause into the motor.
- The specification of the duty cycle (DC) refers to the stepper motor typical cycle time of 10 s: e.g. DC 50 % (2.5 s RUN CW / CCW RUN 2.5 s / 5 s pause)

Please consider the above conditions of the derating measurements, and evaluate these conditions in your system. If individual factors are improved, e.g. the air circulation of the module, the application of the module will be improved significantly.

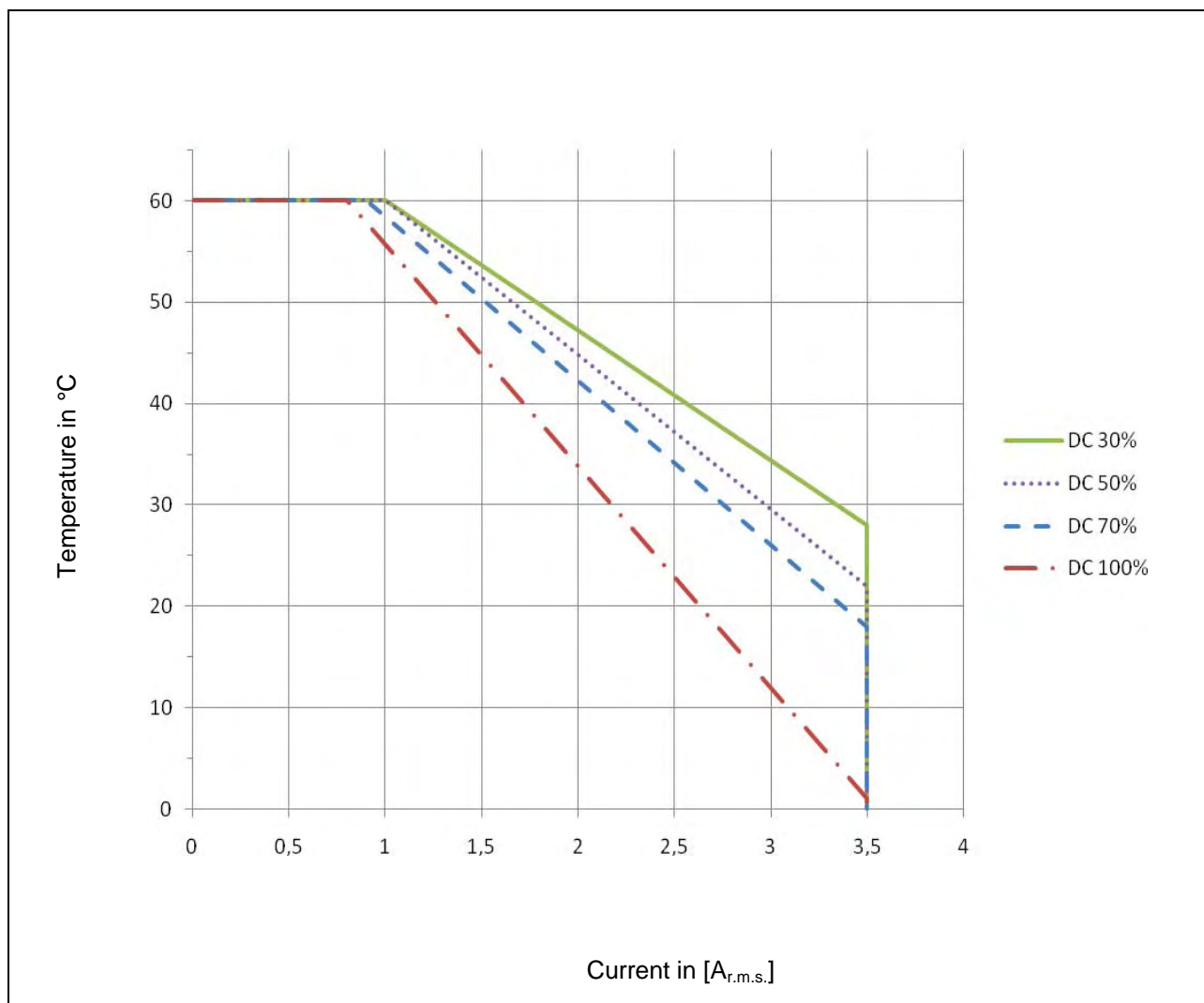

Fig. 8: Correlation between phase current and ambient temperature for **vertical** mounting

1-STEP-DRIVE Module

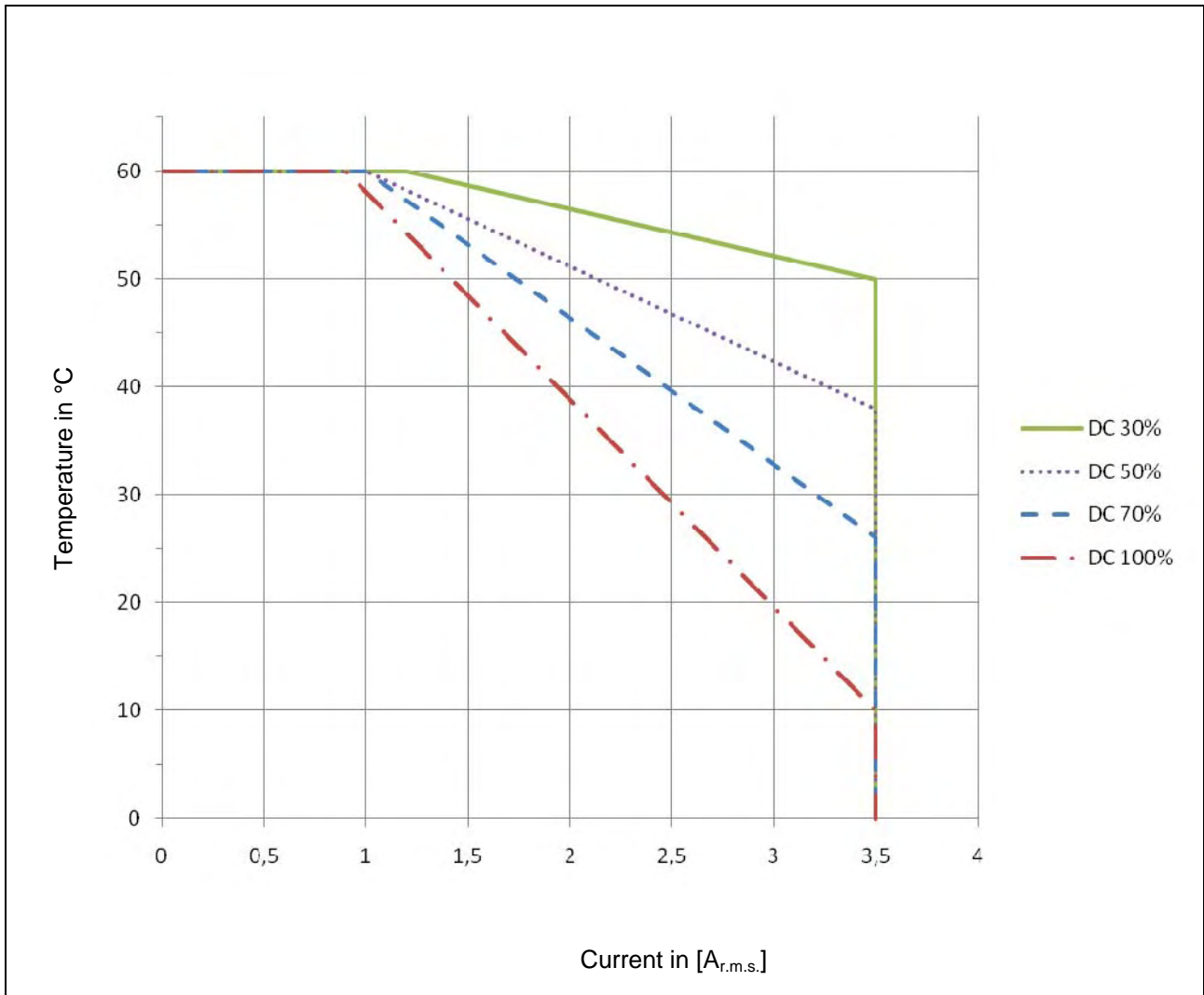

Fig. 9: Correlation between phase current and ambient temperature for **horizontal** mounting

5.4 Temperature Behavior at Typical Application Conditions

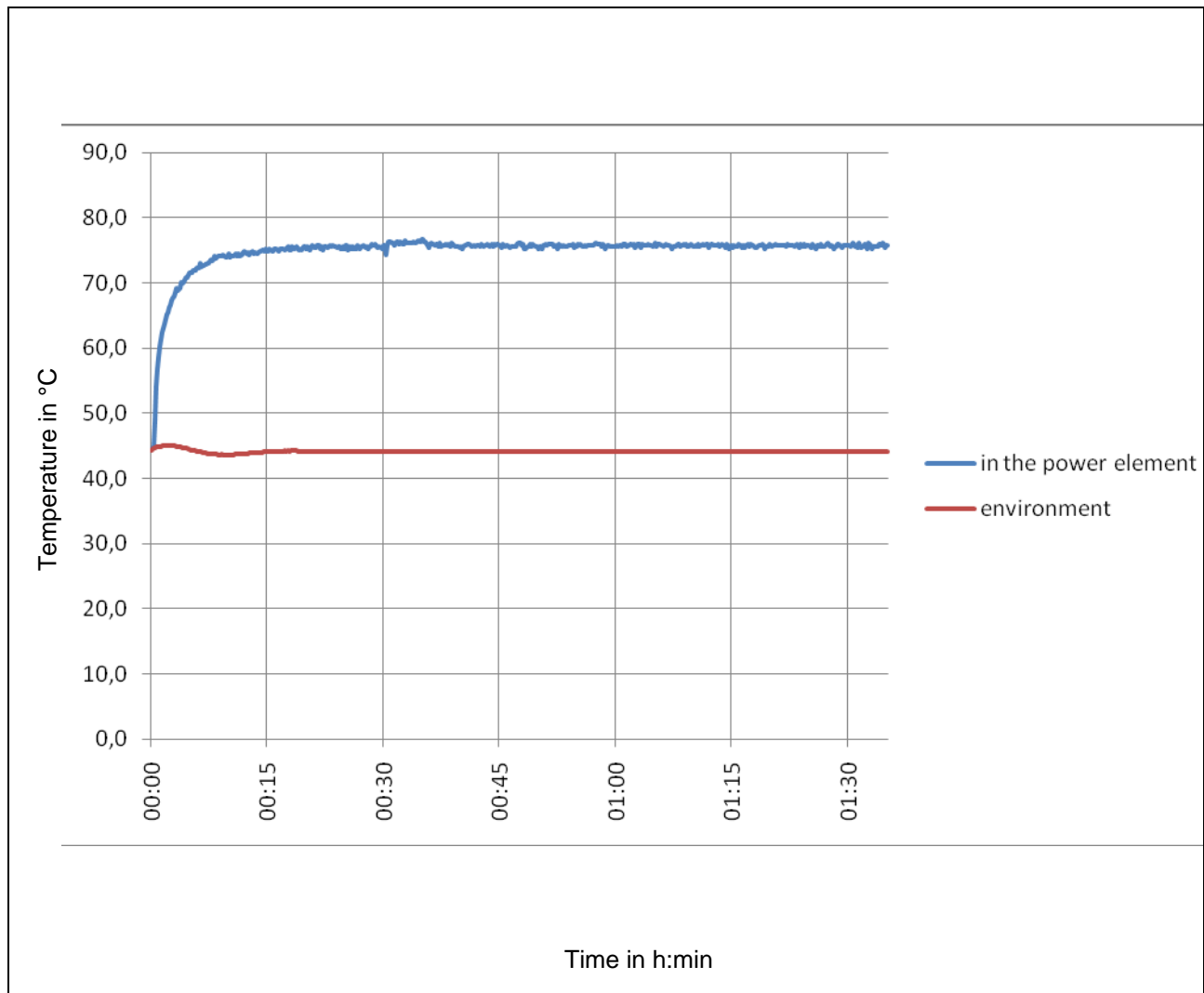

Fig. 10: Heating curve in typical use

The heating curve describes the temperature behavior of the 1-STEP-DRIVE at typical application conditions :

45 °C ambient temperature, 100 % Duty cycle (DC) with air circulation in the control cabinet.

Measuring conditions or operation:

$$U = 24 V_{DC}$$

$$I_{motor} = 3.5 A_{r.m.s.}$$

DC = 100%

Step frequency: 1 kHz, 1/8 step

Ambient temperature: 45 °C controlled

Air circulation at 45 °C

1-STEP-DRIVE Module

5.5 Electrical Installation

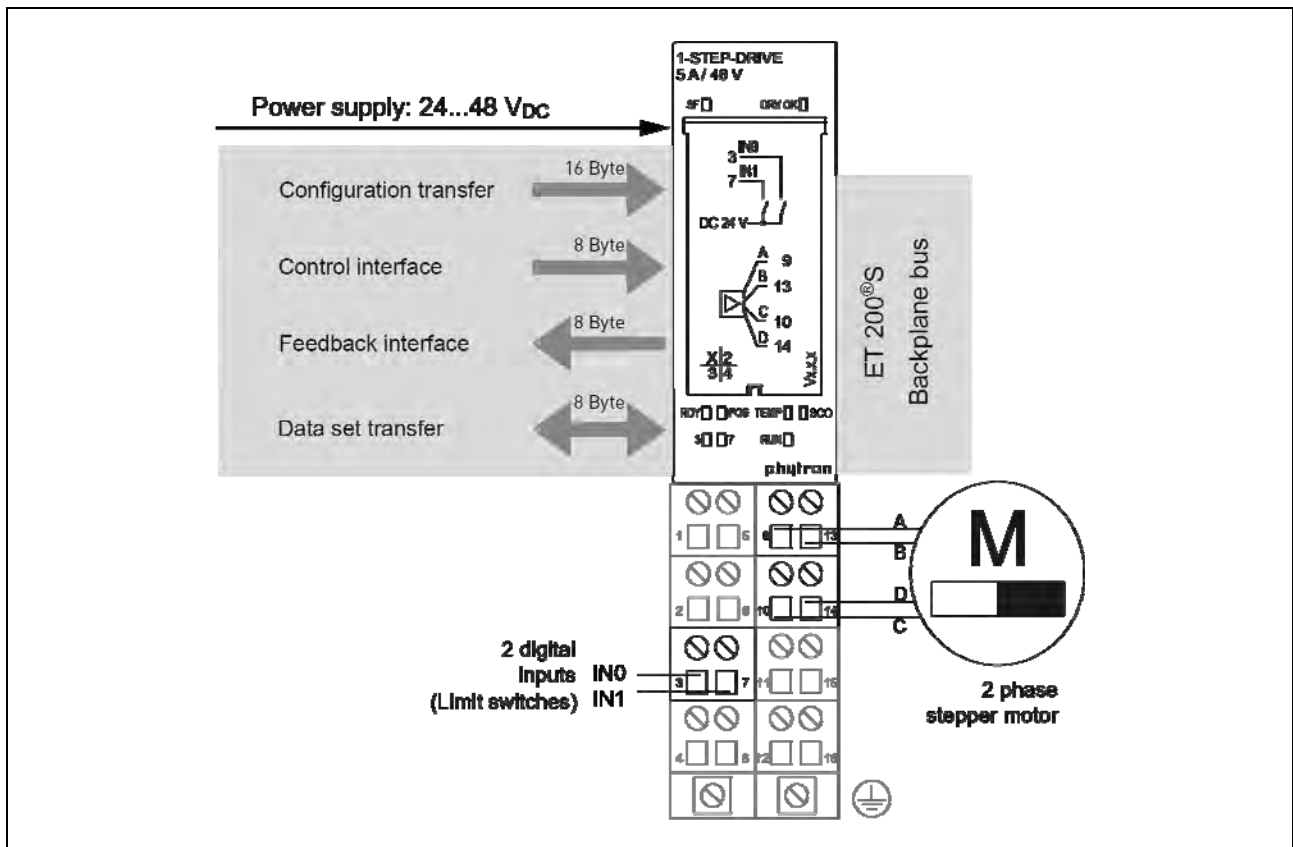

Fig. 11: Terminal assignment

DANGER



Danger of electrical arcing!

Do not unplug the connector while powered!

Load voltage must be powered off by external switches or a removable fuselink!

5.5.1 Motor Connection

The following chapter describes how to wire different types of two phase stepper motors.

1-STEP-DRIVE stepper motor power stages may be connected to stepper motors with 0.1 to 5 A_{Peak} phase current.

Stepper motors with 8 leads can be connected with the windings wired in parallel (1) or series (2).

For 6-lead stepper motors, wiring scheme (3) with series windings is recommended.

If wiring scheme (3) cannot be used because of the motor construction, the motor may be operated with only two of the four windings energized according to wiring scheme (5).



Damage of the power stage!

5-lead stepper motors must **not** be connected to the 1-STEP-DRIVE.

Motor time constant τ :

$\tau = \frac{L}{R}$ applies to the motor's electrical time constant τ .

The total inductance L_{total} is equal to the winding inductance in a parallel circuit, because of shared inductances.

$L_{total} = 4 \times L$ applies to a series circuit.

The result is an equal motor time constant τ for a serial and a parallel circuit:

Circuit	series	parallel
Resistance R_{total}	$2 \times R$	$\frac{R}{2}$
Inductance L_{total}	$4 \times L$	L
Motor time constant τ	$\tau_{series} = \frac{4 \times L}{2 \times R} = \frac{2 \times L}{R}$	$\tau_{parallel} = \frac{L}{R/2} = \frac{2 \times L}{R}$

1-STEP-DRIVE Module

5.6 Wiring Schemes

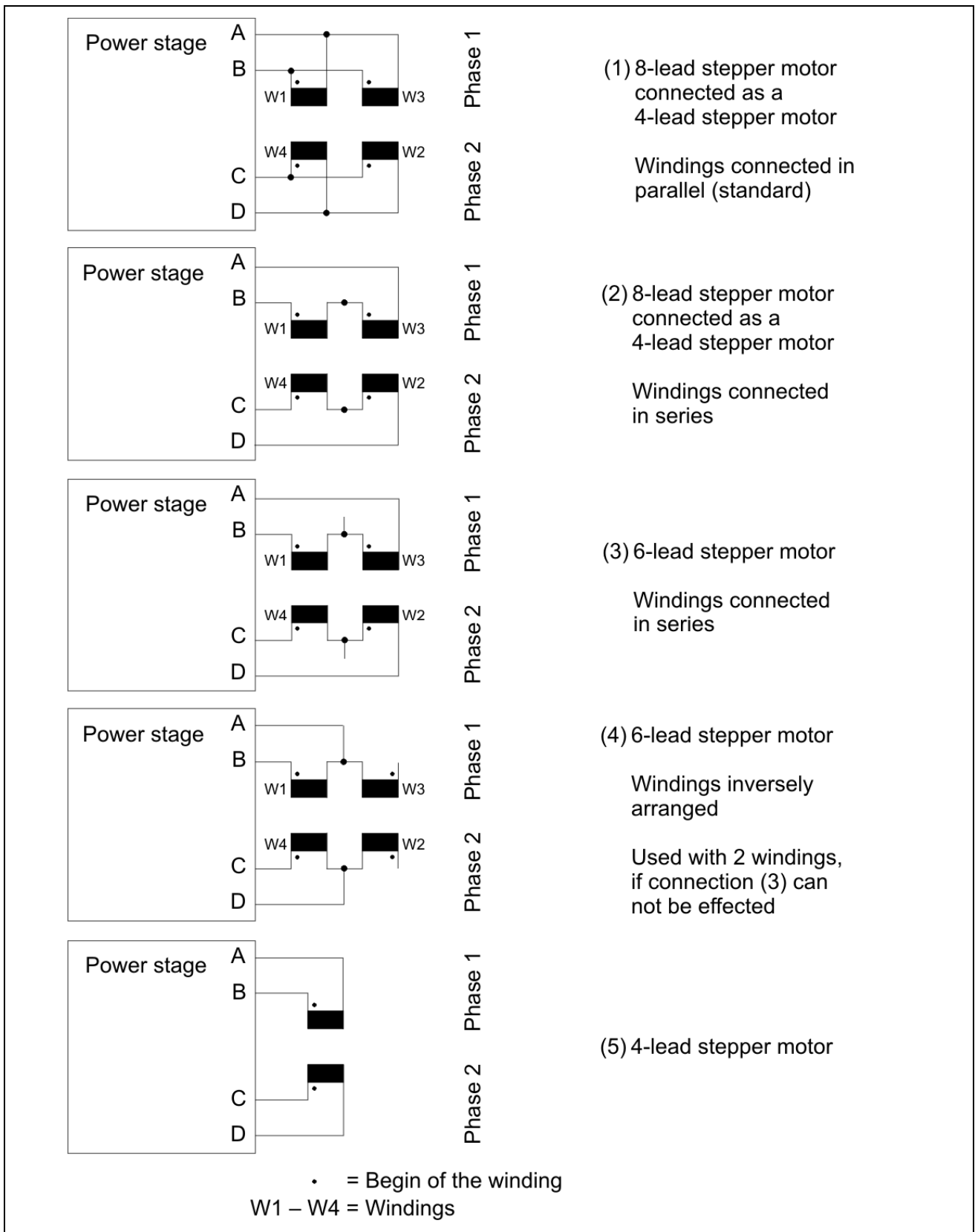









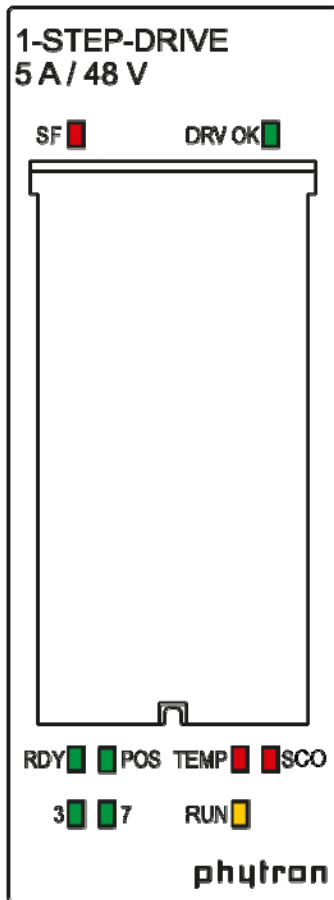

Fig. 12: Connection diagrams for 4-, (6-) and 8- wire stepper motors

5.7 Diagnostics by the LEDs

The LEDs indicate the status and error of the power stage of the 1-STEP-DRIVE module by colours:

LED	Color	Meaning
SF	 red	Group error: 1-STEP-DRIVE module failure
DRV OK	 green	Power stage is ready.
RDY	 green	The module is correctly configured and pulse enable has been activated.
POS	 green	Traversing job is running.
3	 green	Digital input IN0 is activated.
7	 green	Digital input IN1 is activated.
TEMP	 red	Error: Over temperature > 85°C
SCO	 red	Error: Over current > 10 A
RUN	 yellow	Motor is running



1-STEP-DRIVE Module

6 Commissioning

6.1 Configuration of the Module via STEP[®]7

You begin by adapting the hardware configuration to your existing ET 200[®]S station.

- Start the SIMATIC-Manager.
- Assign a new project name with "File > New Project".
- Select "SIMATIC 300 Station" from the HW Config table with "Add Object".
- Open the HW Config configuration table in your project by double-click on "Hardware".
- Open the dialog by click on "Options → Install HW Updates ..." "Install hardware update".
- Select "Copy from disk" and click on "Run".
- Select the hardware description file from the CD (HSP Step7 or HSP TIA) and click on "Open".
- After the file has been copied, mark it in the selection list and click on "Install"
- If the file has been successfully installed, 1-STEP-DRIVE module can be selected in the Hardware Catalog.
- Select all the records of connected hardware modules via drag and drop from the hardware catalog: e.g. ET 200[®]S (IM151-7CPU), PM, DI, DA, 1-STEP-DRIVE, etc.
- Open this mask "Properties 1-STEP-DRIVE" by double clicking on this number.
- On the addresses tab, you will find the addresses of the slot to which you have dragged the 1-STEP-DRIVE. Make a note of these addresses for subsequent programming.
- The parameter's tab contains the default settings for the 1-STEP-DRIVE. If you don't connect any limit switches to the 1-STEP-DRIVE set the parameters IN0 to minus, IN1 to plus and all inputs to "NOC". Set the "Function DI0 " as an "External STOP".
- Save and compile your configuration by , and download the configuration in STOP mode of the CPU by  "PLC -> Download to Module".
- The "SF" LEDs light up only for a short time after a successful data transfer.

6.2 Parameterizing of the Module via STEP[®]7

The next step sets the parameters for the 1-STEP-DRIVE module with STEP[®]7.

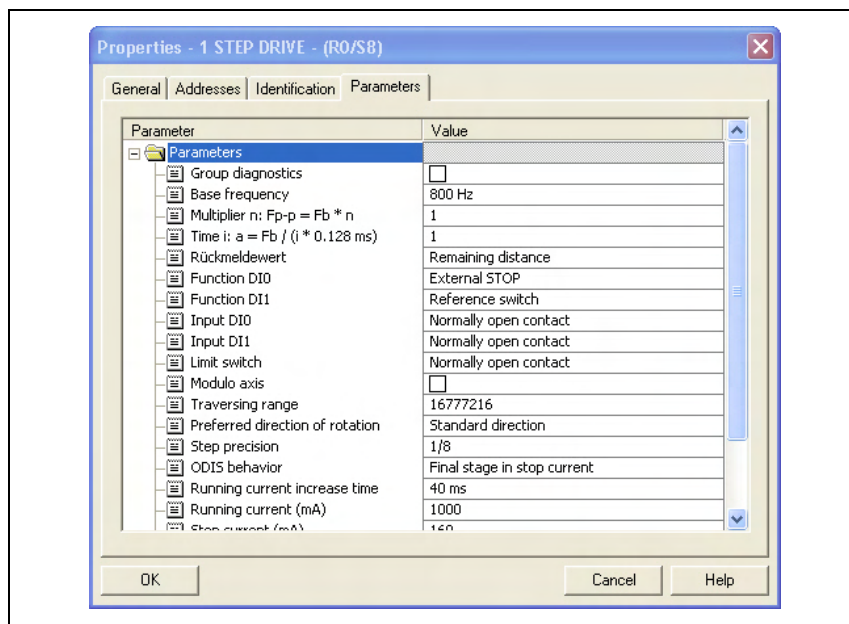

Fig. 13: Parameter list

Clicking on **OK** saves the parameters on the master control.

6.2.1 Examples for a Parameter selection

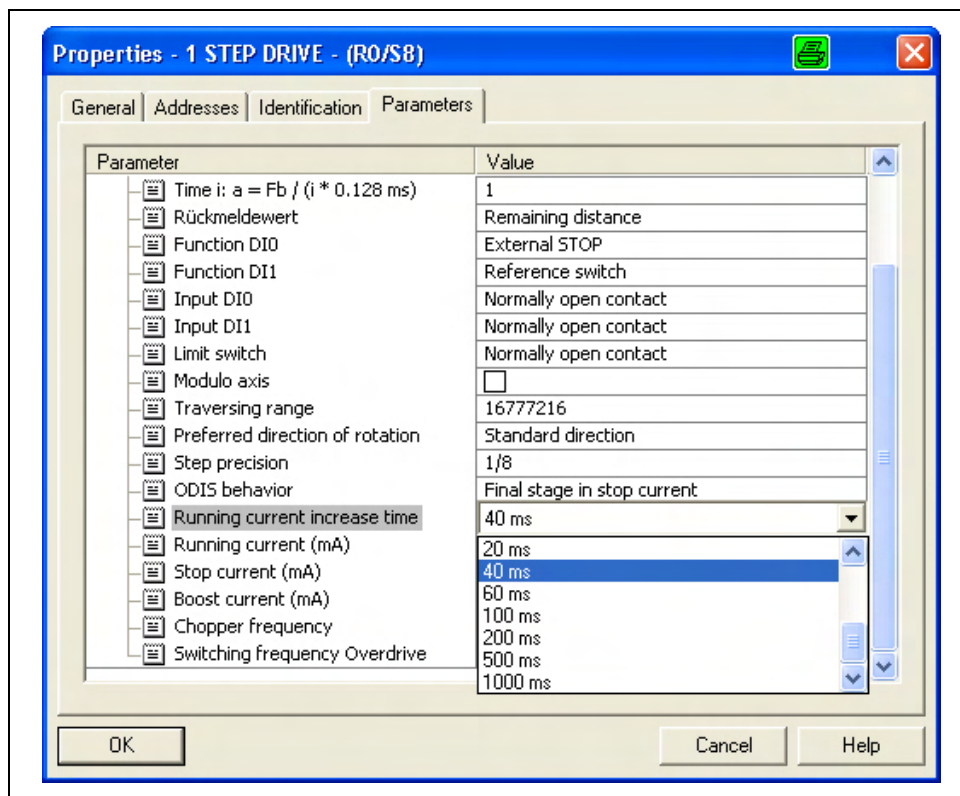

Fig. 14: Example for the power stage: Current delay time

1-STEP-DRIVE Module

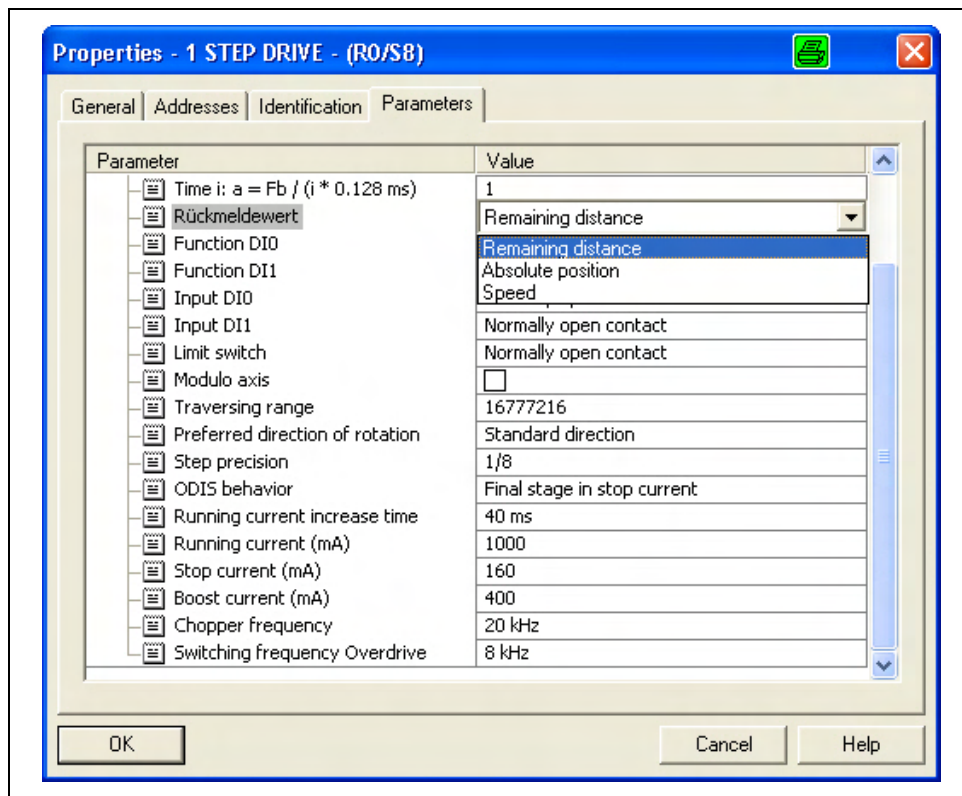

Fig. 15: Example for Positioning: Residual distance

6.2.2 Parameter list

The following parameters are selectable:

Parameters	Explanation
Enable	
Group diagnostics	Generation and transmission of channel-specific diagnostic messages on the module to the CPU is switched on or off: <ul style="list-style-type: none"> - Parameterized error (error type: 10000) - Internal module error (error type: 01001)
Traverse Frequency	
Base frequency F_b in Hz	F_b Base value in Hz for setting of the <ul style="list-style-type: none"> - Start-Stop Frequency, - Starting Frequency - Acceleration/delay
Multiplier n : $F_{PP} = (F_b \times n \times R) / L$	Using the multiplier n to set the F_{PP} start-stop frequency in steps as a multiple of the F_b base frequency.
Acceleration/Delay	
Time interval i : $a = F_b \times R / (i \times 0.128 \times 10^{-3} \text{s} \times L)$	Using the multiplier i to set the acceleration/delay a .
Format feedback interface	
Feedback value	Meaning of the Byte 0 to 3 in the feedback interface: <ul style="list-style-type: none"> - Residual distance - Absolute position - Velocity
Digital inputs	
Function IN0	IN0 (3) digital input can be parameterized as <ul style="list-style-type: none"> - External pulse enable - External STOP - Limit switch forward - Limit switch backward. <p>When used as an external STOP an external signal can terminate a move. The input must be set during operation when using an external pulse enable.</p>

1-STEP-DRIVE Module

Parameters	Explanation
Function IN1	The digital input IN1 (7) can be parameterized as <ul style="list-style-type: none"> - Reference switch (Reference cam) - Reference switch and limit switch forward - Reference switch and limit switch backward
IN0 input, IN1 input, limit switches	Input configuration as NCC or as NOC.
Feedback interface	
Feedback value	Meaning of the Byte 0 to 3 in the feedback interface: <ul style="list-style-type: none"> - Residual distance - Absolute position - Velocity
Axis type and traversing range	
Modulo axis	Activate the modulo axis mode.
Traversing range	Permissible values from 1 to 16777216.
Power stage (stepper motor)	
Preferred direction of rotation	Definition of the Motor direction: 1:Reversing the direction
Step resolution	Increase of the number of steps per revolution: 1/1, 1/2, 1/2.5, 1/4, 1/5, 1/8, 1/10, 1/16, 1/20, 1/32, 1/64, 1/128, 1/256, 1/512 of a full step
ODIS behavior	The state of the power stage is dependent on the ODIS-signal: 0: Power stage is deactivated 1: Power stage remains with stop current

Parameters	Explanation
Current delay time	<p>The time after the last control pulse until the stop current is activated:</p> <p>0 : 1 ms 1 : 2 ms 2 : 4 ms 3 : 6 ms 4 : 8 ms 5 : 10 ms 6 : 12 ms 7 : 14 ms 8 : 16 ms 9 : 20 ms 10 : 40 ms 11 : 60 ms 12 : 100 ms 13 : 200 ms 14 : 500 ms 15 : 1000 ms</p>
Run current	<p>Current during the motor run: Range: 0 to 3500 mA_{r.m.s.} in 20mA steps</p>
Stop current	<p>Motor current applied after the 'current delay time' when the motor is stopped: Range: 0 to 3500 mA_{r.m.s.} in 20mA steps</p>
Boost current	<p>Current of the acceleration and deceleration phases of the motor: Range: 0 to 3500 mA_{r.m.s.} in 20mA steps</p>
Chopper frequency	<p>Frequency of the pulse width modulation for the motor current: 0 : 18 kHz 1 : 20 kHz 2 : 22 kHz 3 : 25 kHz</p>
Switching frequency Overdrive	<p>Step frequency, at which the phase current is increased by $\sqrt{2}$ (=Overdrive): 0 : 1 kHz 1 : 2 kHz 2 : 4 kHz 3 : 8 kHz 4 : 10 kHz 5 : 15 kHz 6 : 20 kHz 7 : Overdrive off</p>

1-STEP-DRIVE Module

6.2.3 Causes of Parameter Setting Errors

- Invalid base frequency
- Multiplier $n = 0$
- Multiplier $i = 0$
- Invalid combination of the functions of the digital inputs (both as limit switch forward or both as limit switch backward)
- Invalid feedback value for the feedback interface
- Traversing range out of range of values
- Invalid step resolution

6.3 Programming of the ET 200[®]S with the SIMATIC Manager (Example)

6.3.1 Task Example

Include the following FC 101 block FC 101 in your user program, i.e. into OB 1. This block requires the DB1 data block with a length of 16 bytes. In the example below, the start is initiated by setting memory bit 30.0.

6.3.2 Implementation of the Program Steps



1. Enter the block name (e.g. FC101) (right click) "Add New Object >Function"; created in the statement list (STL).
2. Enter the following commands line by line:

```

L   L#4800           //Distance 4800 number of pulses
T   DB1.DBD  0
L   1               //Multiplier 1 for start frequency
T   DB1.DBB  0
L   0               //Delete limit switch etc.
T   DB1.DBB  5
T   DB1.DBW  6
SET
S   DB1.DBX  5.2    // Set pulse enable DRV_EN
R   DB1.DBX  4.0    //Set 'Relative incremental' operating mode
R   DB1.DBX  4.1    // Set 'Relative incremental' operating mode
R   DB1.DBX  4.2    // Set 'Relative incremental' operating mode
R   DB1.DBX  4.3    //Reserve bit = 0
R   DB1.DBX  4.5    //Start backwards delete DIR_M
R   DB1.DBX  4.6    //Delete STOP
R   DB1.DBX  4.7    // Delete reduction factor R
L   DB1.DBD  0      //Write 8 Byte to the 1-STEP-DRIVE
T   PAD 256
L   DB1.DBD  4
T   PAD 260
L   PED 256         //Read 8 Byte from 1-STEP-DRIVE
T   DB1.DBD  8
L   PED 260
T   DB1.DBD  12
U   M 30.0          // Detect flank of the start impulse and start DIR_P
UN  DB1.DBX 12.0    //Set if STS_JOB is deleted
S   DB1.DBX  4.4
U   DB1.DBX 12.0    //Wait on STS_JOB
R   DB1.DBX  4.4    //Reset Start DIR_P, the traversing starts
R   M 30.0          //Delete start impulse

```

Fig. 16: Program example FC101 block

3. Create with <Add New Object> "Data Block" (right-click) a data block (DB1) as a 16-byte placeholder file.
4. Save all the selected blocks with  and load them with  into the ET 200[®]S.

1-STEP-DRIVE Module



The FC101 block is stored in the user program.
The addresses in the program above are examples. The E- and A-address have to be adjusted to HW-Konfig.
You will find a demo application program for the 1-STEP-DRIVE module on the CD or you can download from the product site of the 1-STEP-DRIVE on www.phytron.de.

6.3.3 Program Test

Start a "relative incremental mode" and monitor the associated feedback.

1. Using "Monitor/Modify Variables", check the residual distance and the status bits POS (positioning in operation) and STS_DRV_EN (pulse enable).
2. Select the "Block" folder in your project. Choose the "Insert > S7 Block > Variable Table" menu command to insert the VAT 1 variable table, and then confirm with OK.
3. Open the VAT 1 variable table, and enter the following variables in the "Address" column:
 - DB1.DBD8 (residual distance)
 - DB1.DBX13.7 (POS, positioning in operation)
 - DB1.DBX13.0 (STS_DRV_EN, pulse enable)
 - M30.0 Start by means of the programming device
4. Choose "PLC > File Connect To > Configured CPU" to switch to online.
5. Choose "Variable > Monitor" to switch to monitoring.
6. Switch the CPU to RUN mode.

6.3.4 Program Result

When you switch the CPU to RUN, the following results are obtained:

- The RDY LED lights up.
- The POS status bit is deleted.
- The STS_DRV_EN status bit is set.

Start the run by setting memory bit 30.0 ("Variable > Modify >").

The following result is obtained during the run:

- The POS status bit is set (you can see this by monitoring the variable); that is, the POS LED lights up.
- The residual distance is continuously updated.
- The STS_DRV_EN status bit (pulse enable) is set.

The following result is obtained after the run has been completed:

- The POS status bit is deleted (you can see this by monitoring the variable); that is, the POS LED is no longer illuminated.
- The residual distance is 0.
- The STS_DRV_EN status bit (pulse enable) is set.

6.3.5 Traversing Job, Parameter Changing and Troubleshooting

Traversing Job Start

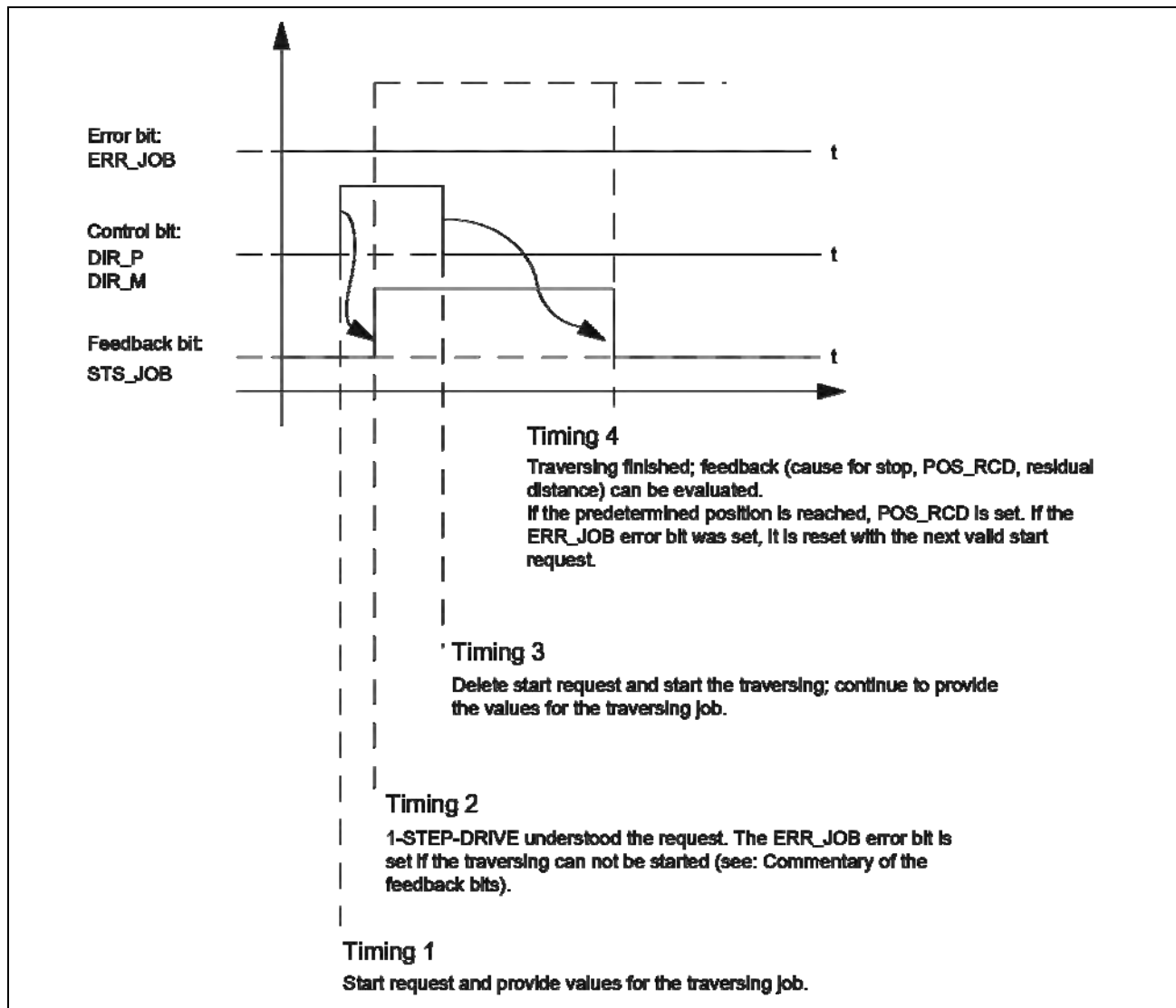

Fig. 17: Starting the traversing job

Evaluating the ERR_JOB error bit

As soon as the STS_JOB feedback bit is cleared at time stamp 4, evaluate the ERR_JOB error bit. Note that the STS_JOB feedback bit is only cleared if the DIR_P, DIR_M, and C_PAR control bits are cleared.

Carrying Out a Parameter Change

1-STEP-DRIVE Module

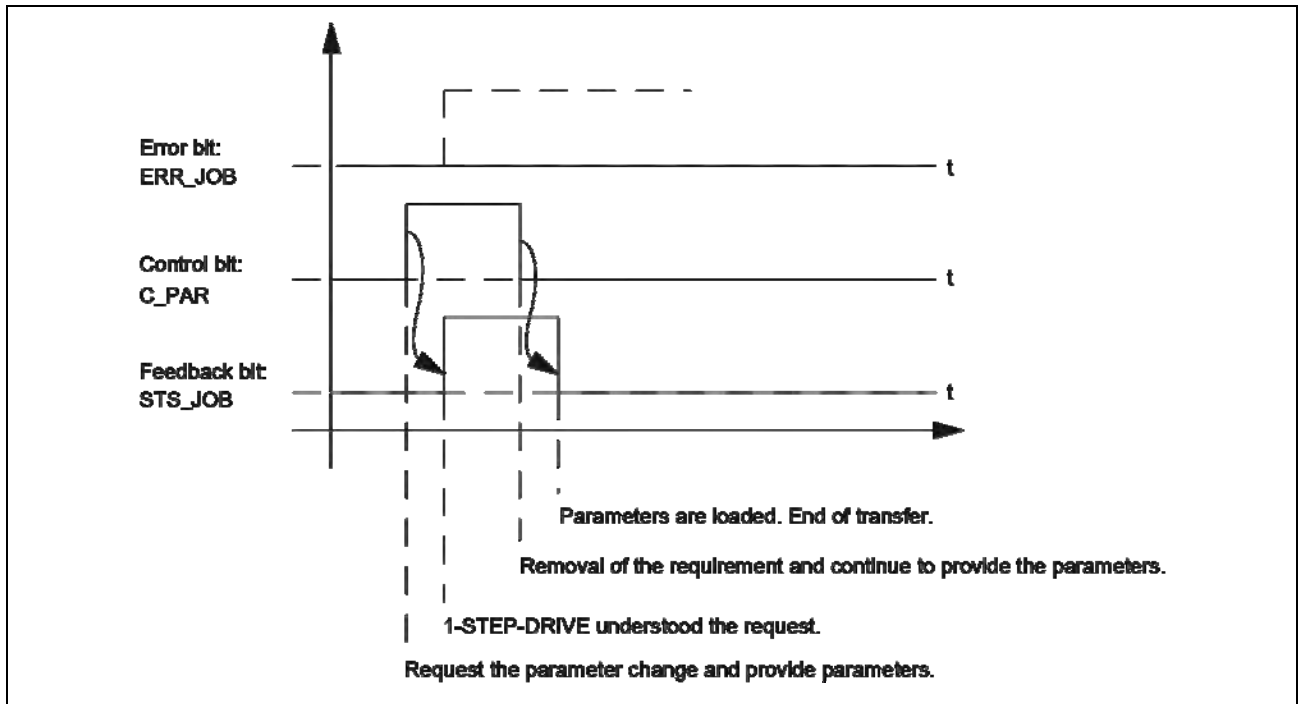

Fig. 18: Carrying Out a Parameter Change

i Only one of the following control bits can be set at a particular time: DIR_Por DIR_Mor C_PAR. Otherwise, the ERR_JOB error is reported. The job error message is deleted by the start of the next job.

Error detection

The "power stage error" has to be acknowledged. It has been detected by the 1-STEP-DRIVE and indicated in the feedback interface. Channel-specific diagnostics are executed if you enabled group diagnostics are enabled when assigning parameters. The parameter assignment error bit is acknowledged by means of correct parameter assignment:

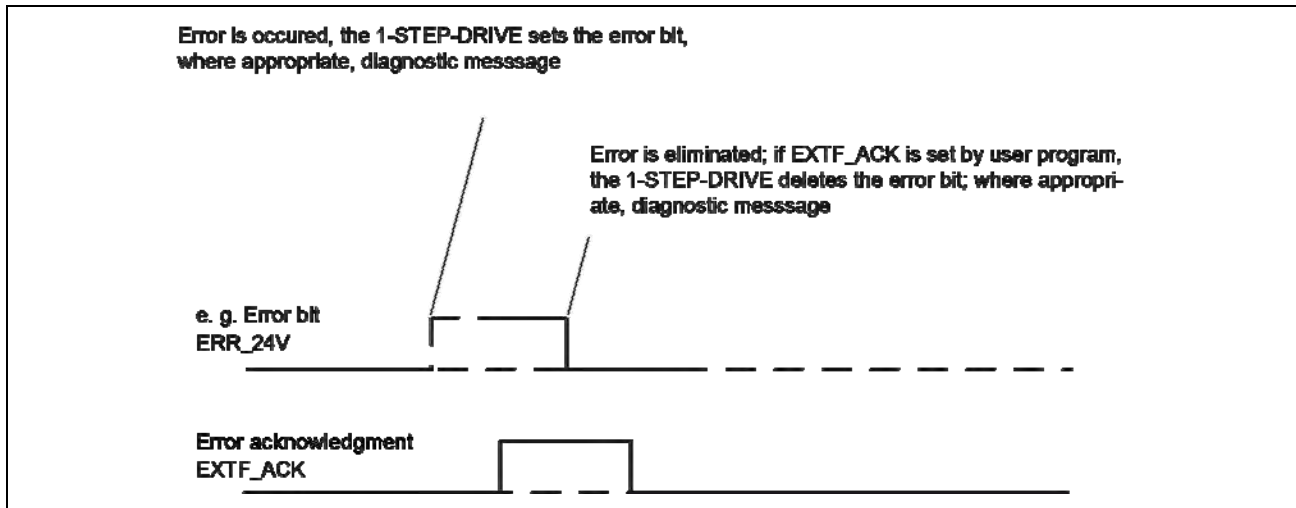

Fig. 19: Acknowledgment

In the case of constant error acknowledgment ($EXTF_ACK = 1$) or in CPU/master STOP mode, the 1-STEP-DRIVE reports the error as soon as it is detected and clears the error as soon as it is eliminated

1-STEP-DRIVE Module

7 Data Transfer in Operation

At the control and feedback interface, the called parameter jobs are synchronized with the clock of the CPU transmitted or read.

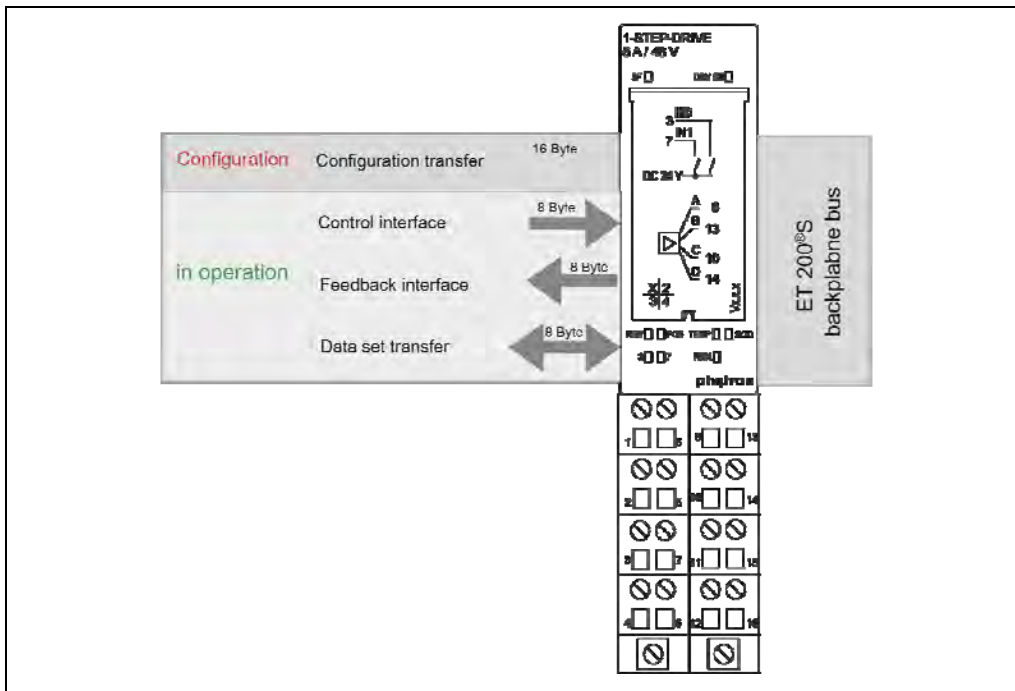

Fig. 20: Data interfaces

Interface assignment

i For the 1-STEP-DRIVE, the following data of the control and feedback interface are consistent:

- Bytes 0 to 3
- Bytes 4 to 7

Use the access or addressing mode for data consistency over the entire control and feedback interface on your DP master (only for configuration using the GSD file).

Access to Control and Feedback Interface in STEP[®]7 Programming

	Configuring with STEP [®] 7 via GSD file 1) (hardware catalog\PROFIBUS DP\Other Field Devices\ET 200 [®] S)	Configuring with STEP [®] 7 using HW Config (hardware catalog\PROFIBUS DP\ET 200 [®] S)
Control interface	Write with SFC 15 "DPWR_DAT"	Transfer command, e. g. T PAD
Feedback interface	Read with SFC 14 "DPRD_DAT"	Load command, e. g. L PED
1) Load and transfer commands are also possible with CPU 3xxC, CPU 318-2 (as of V3.0), CPU 4xx (as of V3.0).		

7.1 Control Interface

7.1.1 Assignment

The assignment of the control interface is in the following table:

Byte	Assignment	
0 to 3	Relative incremental mode, absolute incremental mode	
	Byte 0	Multiplier G: $F_a = F_b \times R \times G$ (value range 1 ... 255)
	Byte 1	Distance or position Bit 23 ... Bit 16
	Byte 2	Distance or position Bit 15 ... Bit 8
	Byte 3	Distance or position Bit 7 ... Bit 0
	or Reference point approach	
	Byte 0	Multiplier G: $F_a = F_b \times R \times G$ (value range 1 ... 255)
	Byte 1	Position Bit 23 ... Bit 16
	Byte 2	Position Bit 15 ... Bit 8
	Byte 3	Position Bit 7 ... Bit 0
	or Set home position	
	Byte 0	Reserved = 0
	Byte 1	Position Bit 23 ... Bit 16
	Byte 2	Position Bit 15 ... Bit 8
	Byte 3	Position Bit 7 ... Bit 0
	or Velocity control mode	
	Byte 0 to 3	Frequency as STEP [®] 7-Datatype REAL
	or Parameter Assignment Request	
	Byte 0	Reserved = 0
	Byte 1	Multiplier i: $a = F_b \times R / (i \times 0,128 \text{ ms})$ (value 1 ... 255)
	Byte 2	Multiplier n: $F_{ss} = F_b \times n \times R$ (value 1 ... 255)
	Byte 3	Base frequency F_b : <ul style="list-style-type: none"> • 0 = 800 Hz • 1 = 400 Hz • 2 = 200 Hz • 3 = 80 Hz • 4 = 40 Hz • 5 = 20 Hz • 6 = 8 Hz • 7 = 4 Hz • 8 = 2000 Hz

1-STEP-DRIVE Module

Byte/ Bit	Bit 7	Bit 6	Bit 5	Bit 4	Bit 3	Bit 0 bis 2	
Byte 4	Reduction factor 0: Factor 1.0 (no reduction) 1: Factor 0.1	Hold traversing job	Backward start	Forward start	Reserved = 0	Mode: 0: Relative incremental mode (relative positioning) 1: Reference point approach 2: Absolute incremental mode (absolute positioning) 3: Velocity control mode 4: Set home position	
	R	STOP	DIR_M	DIR_P	I	MODE	
Byte 5	Diagnostics error acknowledgement	Change parameters	Feedback value in the feedback interface 00: Residual distance 01: Position 10: Frequency 11: Reserved		Stop at the reference cam	Pulse enable	Limit switch in the
			Forward direction	Backward direction			
	EXTF_ACK	C_PAR	FEEDBACK	STOP_REF_EN	DRV_EN	LIMIT_P	LIMIT_M
Byte 6	Reserved =0						
Byte 7							

7.1.2 Notes for the Control Bits

Control Bits	Notes
Base Frequency F_b	<p>Coding for setting the base frequency in steps:</p> <ul style="list-style-type: none"> • 0 = 800 Hz • 1 = 400 Hz • 2 = 200 Hz • 3 = 80 Hz • 4 = 40 Hz • 5 = 20 Hz • 6 = 8 Hz • 7 = 4 Hz • 8 = 2000 Hz
Operating mode	<p>Coding for operating mode:</p> <ul style="list-style-type: none"> • 0 = Relative incremental mode (relative positioning) • 1 = Reference point approach • 2 = Absolute incremental mode (absolute positioning) • 3 = Speed control mode • 4 = Set home position
C_PAR	A parameter change is requested with this bit.
DIR_M	This bit requests and starts a traversing job in the reverse direction.
DIR_P	This bit requests and starts a traversing job in the forward direction.
Frequency	A 32-bit value (STEP [®] 7 data type REAL) that contains the pulse frequency to be output.
DRV_EN	If DI0 (3) digital input is used as an external STOP, this bit is interpreted as a pulse enable.
Limit switch LIMIT_M	This limit switch limits the travel range in the reverse direction. Set or clear this bit in your user program.
Limit switch LIMIT_P	This limit switch limits the travel range in the forward direction. Set or clear this bit in your user program.
EXTF_ACK	Acknowledgment bit for diagnostic message
Multiplier G	Factor for setting the velocity / output frequency in steps
Multiplier i	Factor for setting the acceleration / deceleration in steps
Multiplier n	Factor for setting the start-stop frequency in steps

1-STEP-DRIVE Module

Control Bits	Notes
Position	24 bit value that contains the target position to be approached
Reduction factor R	The Base Frequency F_b is multiplied by 0.1 if the bit is set. This reduces the Starting Frequency F_a , the Start-Stop Frequency F_{ss} , and the acceleration / deceleration a by the same amount.
STOP	With this bit, you can stop a traversing job with a delay ramp at any time (see chap. 8.4.7 "Hold Traversing Job").
STOP_REF_EN	When the bit is set, the "Stop at the reference cam" function is active. When the reference cam is recognized, the traversing job is stopped with a deceleration ramp (see chap. 8.4.7 "Hold Traversing Job").
FEEDBACK	Coding for the feedback value in the feedback interface: <ul style="list-style-type: none">• 00 = Residual distance• 01 = Position• 10 = Frequency• 11 = Reserved
Distance	A 24 bit value that contains (without signs) the number of pulses those have to be traversed.

7.2 Feedback Interface

7.2.1 Assignment

Byte	Assignment							
Byte 0 to 3	Bit 31...0							
	Residual distance (Bit 23 ... Bit 0 of 32 Bit) or Position (Bit 23 ... Bit 0 of 32 Bit) or Frequency (32 Bit, STEP [®] 7-Data type REAL)							
Byte/Bit	Bit 7	Bit 6	Bit 5	Bit 4	Bit 3	Bit 2	Bit 1	Bit 0
Byte 4	Power stage error	Reserved = 0	Parameter assignment error	Determining the home position	Reserved = 0	Position reached	Error during job transfer	Job transfer running
	ERR_DRV		ERR_PARA	SYNC		POS_RCD	ERR_JOB	STS_JOB
Byte 5	Traversing job running	Limit switch		external STOP	Reference cam	Status IN0	Status IN1	Status pulse enable active
		forward	backward					
		Is the cause for stop						
	POS	STOP_LIMIT_P	STOP_LIMIT_M	STOP_EXT	STOP_REF	STS_IN0	STS_IN1	STS_DRV_EN
Byte 6	Error number at an error during job transfer							
Byte 7	Reserved = 0							

1-STEP-DRIVE Module

7.2.2 Notes on the Feedback Bits

Feedback Bits	Notes
Frequency	A 32 bit value (STEP [®] 7 data type REAL) that contains the current pulse frequency.
ERR_JOB	This bit is set if the job is not clear or not possible. The error cause is specified in more detail by the returned error number (see the following table "Error number in the feedback interface").
ERR_PARA	Incorrect parameter assignment for the ET 200 [®] S station. The error cause is specified in more detail by the returned error number (see the following table "Error number in the feedback interface"). The parameter error bit is deleted when a correct parameter assignment is transmitted.
ERR_DRV	The power stage was overloaded or it has a fault and is now turned off (deactivated). ERR_DRIVE is reset when it was acknowledged with the control bit EXT_F_ACK. If the overload is removed, the power stage is switched on again and ERR_DRIVE is deleted.
Error number	Specifies the error cause if ERR_JOB or ERR_PARA is set (see table below "Error numbers in the feedback interface").
POS	Traversing: This bit is set as long as the traversing job is running.
POS_RCD	POS_RCD is cleared at the start of an incremental mode or at specification of a new set point frequency in velocity control mode. POS_RCD is set after a correctly executed incremental mode or when the set point frequency has been reached in velocity control mode. If traversing was interrupted (if the traversing job has stopped or the pulse enable is deleted), POS_RCD remains cleared (see chap. 8.4.7 "Hold Traversing Job" and "Pulse Enable" (chap. 8.4.9)).
Position	A 24 bit value that contains the current absolute position (without signs). Byte 0 of the feedback interface is 0.
Residual distance	A 24 bit value that contains the number of pulses those still have to be traversed (without signs). Byte 0 of the feedback interface is 0.
STOP_EXT	Cause for stop: This bit is set if the traversing job has been stopped by an external STOP.
STOP_LIMIT_M	Cause for stop: This bit is set if the traversing job has been stopped by reaching the reverse limit switch.

Feedback Bits	Notes
STOP_LIMIT_P	Cause for stop: This bit is set if the traversing job has been stopped by reaching the forward limit switch.
STOP_REF	Cause for stop: This bit is set if the traversing job has been stopped by reaching of the reference cam.
STS_IN0	The bit displays the status of the DI0 (3) digital input..
STS_IN1	The bit displays the status of the DI1 (7) digital input.
STS_DRV_EN	<p>This bit is set when one of the following occurs, depending on the assigned parameter function of the digital input DI0:</p> <ul style="list-style-type: none"> • The external pulse enable is set. <p>or</p> <ul style="list-style-type: none"> • The DRV_EN control bit is set for the pulse enable.
STS_JOB	This bit is set as feedback when a job request for a traversing or parameter assignment job is detected and then reset when the job has been executed.
SYNC	This bit is set after a correct reference point approach or after manual specification of the home position has been set. The SYNC bit is cleared after parameter assignment with new ET 200 [®] S station parameters or after deletion of the pulse enable.

1-STEP-DRIVE Module

7.2.3 Error numbers in the Feedback Interface

When in the feedback interface, any error with the job command (ERR_JOB is set), or an error is flagged in the base parameters (ERR_PARA is set), causes an additional, more precise, indication of the fault.

Error number	Meaning
General error causes	
0	No error (then ERR_JOB or ERR_PARA is also not set)
1	Combination of the control bits (DIR_P, DIR_M, C_PAR) is invalid
2	Another job is still running.
Causes of errors with a traversing job	
16	Start forward (DIR_P) at limit switch forward (LIMIT_P) active
17	Start backward (DIR_M) at limit switch backward (LIMIT_M) active
18	Start with set control bit STOP
19	Start at external STOP active
20	Start at a missing pulse enable (internal or external)
21	Start with set STOP_REF_EN with active reference cam
22	Start without reference (at absolute incremental mode)
23	Start with diagnostic error present
24	Start was interrupted by CPU/master STOP
25	Start with incorrect operating mode (not identical with requirement)
26	Distance or position specification is invalid
27	Multiplier G for the velocity is zero
28	Frequency is invalid at velocity control mode
Error causes at a parameter assignment job or for the basic parameter assignment	
32	Specification for the basic frequency is invalid
33	Multiplier n for start-stop frequency is zero
34	Multiplier i for acceleration / delay is zero
35	Feedback value for the feedback interface is invalid
36	Combination of the functions of DI0 and DI1 is invalid (limit switches)
37	Specification for the end of the traversing range is invalid

7.3 Data Set Transfer

All parameters of the data set 80 are preset by the configuration.

The complete data set of the power stage can also be transferred in the run-time to the 1-STEP-DRIVE.

The parameters are changed by the mechanism "Read / write data set". In STEP[®]7 the system functions SFB53 WR_REC (write data set) and SFB52 RD_REC (read data set) are available.

The data set numbers 80 (in writing direction, to the module) and 81 (in reading direction, from the module) are used.

i The data set can only be successfully written, if no positioning (Traversing job) is running. The read back from the module is possible at any time.

7.3.1 Data Set 80: Write Command / Change Parameters

The data set consists of 8 bytes with the following structure:

Byte/Bit	Bit 7	Bit 6	Bit 5	Bit 4	Bit 3	Bit 2	Bit 1	Bit 0	Type
Byte 0	1	Deactivation	Basic position	Reset Error	0	0	0	0	Command bytes
Byte 1	Reserved = 0								Parameter bytes
Byte 2	Reserved = 0			Step resolution 0 : 1/1 1 : 1/2 2 : 1/2.5 3 : 1/4 4 : 1/5 5 : 1/8 6 : 1/10 7 : 1/16 8 : 1/20 9 : 1/32 10 : 1/64 11 : 1/128 12 : 1/256 13 : 1/512 14;15 not possible			Preferred direction of rotation 0: Normal direction 1: Reverse direction		

1-STEP-DRIVE Module

Byte/Bit	Bit 7	Bit 6	Bit 5	Bit 4	Bit 3	Bit 2	Bit 1	Bit 0	Type
Byte 3	Reserved = 0			Current delay time 0 : 1 ms 1 : 2 ms 2 : 4 ms 3 : 6 ms 4 : 8 ms 5 : 10 ms 6 : 12 ms 7 : 14 ms 8 : 16 ms 9 : 20 ms 10 : 40 ms 11 : 60 ms 12 : 100 ms 13 : 200 ms 14 : 500 ms 15 : 1000 ms			ODIS behavior 0 : Power stage deactivated 1 : Power stage in stop current		
Byte 4	Run current 0 ... 3500 in 20 mA increments (300 mA) ¹								
Byte 5	Stop current 0 ... 3500 in 20 mA increments (160 mA) ¹								
Byte 6	Boost current 0 ... 3500 in 20 mA increments (400 mA) ¹								
Byte 7	Reserved = 0			Switching frequency overdrive 0 : 1 kHz 1 : 2 kHz 2 : 4 kHz 3 : 8 kHz 4 : 10 kHz 5 : 15 kHz 6 : 20 kHz 7 : Overdrive off			Chopper frequency 0 : 18 kHz 1 : 20 kHz 2 : 22 kHz 3 : 25 kHz		

Explanation of the Command Bits:

Deactivation	1: Deactivation of the power stage
Basic position	1: Ring counter (pattern) in 0 position
Reset Error	1: Error bit is reset

After the reception of the data set byte 0 and byte 2 to 7 are summarized into one command/ parameter frame, they are transferred to the power stage. A validity test of the parameters does not take place. A possible resulting parameterization error is displayed in the feedback interface of the module, byte 7 bit 0 (status of the module).



Command bytes are immediately become as a 1-byte packet, parameter bytes only as a complete data set (8 bytes).

7.3.2 Data set 81: Read Power Stage Status and Parameters

The data set consists of 8 bytes with the following structure:

Byte/Bit	Bit 7	Bit 6	Bit 5	Bit 4	Bit 3	Bit 2	Bit 1	Bit 0
Byte 0	reserved							
Byte 1	Run	Boost	Basic position	Over temperature	Over current	0	Data set transfer	Parameter assignment error
Byte 2	Reserved			Step resolution			Preferred direction	
Byte 3	Reserved			Current delay time			ODIS behavior	
Byte 4	Run current ¹							
Byte 5	Stop current ¹							
Byte 6	Boost current ¹							
Byte 7	Reserved			Switching frequency Overdrive			Chopper frequency	

Byte 1 contains the status frame of the power stage, bytes 2 to 7 are the parameters transferred to the power stage last.

Explanation of the Status:

Run	1: Run current activated
Boost	1: Boost current activated
Basic position	1: Ring counter(pattern) in 0 position
Over temperature	1: Operation temperature > 85°C
Over current	1: Short circuit > 10 A
Data set transfer	1: Successful transfer of the data set 80
Parameterization error	1: Error during parameterization



The data set can be read **without** restriction.

¹ The current value factor is calculated thus: current value/20, i.e. 1...175_D (1...AF_H)

1-STEP-DRIVE Module

8 Principles of Positioning

8.1 Traversing Curve of the 1-STEP-DRIVE

Revolution frequency of the stepper motor

The revolution frequency of a stepper motor is usually indicated in rpm. From the view of the stepper motor module a frequency is displayed at the output terminal (Starting Frequency F_a). The relationship between the speed of the stepper motor (velocity n) and the displayed frequency (F_a) is as follows:

$$F_a = (n \times s) / (60 \text{ s/min})$$

F_a = Starting frequency in [Hz]

n = Speed in [rpm]

s = Full step resolution of the stepper motor (typical: 200 steps/rev). For further information refer to the technical data for the stepper motor.

General traversing curve of the 1-STEP-DRIVE

Normally each incremental move is always carried out by the same traversal curve.

The stepper motor accelerates without a ramp to the Start-Stop Frequency F_{ss} . Then the stepper motor follows over a parameterization ramp to the desired Starting Frequency F_a . The Range 2 is characterized by moving constant speed. In range 3 the stepper motor is decelerated by a ramp. A System-specific Frequency F_{max} limits the maximum speed of the drive system.

The values (Start-Stop Frequency, Starting Frequency and Deceleration) of the traversal curve define the 1-STEP-DRIVE with a selected base frequency (see chapter 8.2 "Setting the base frequency").

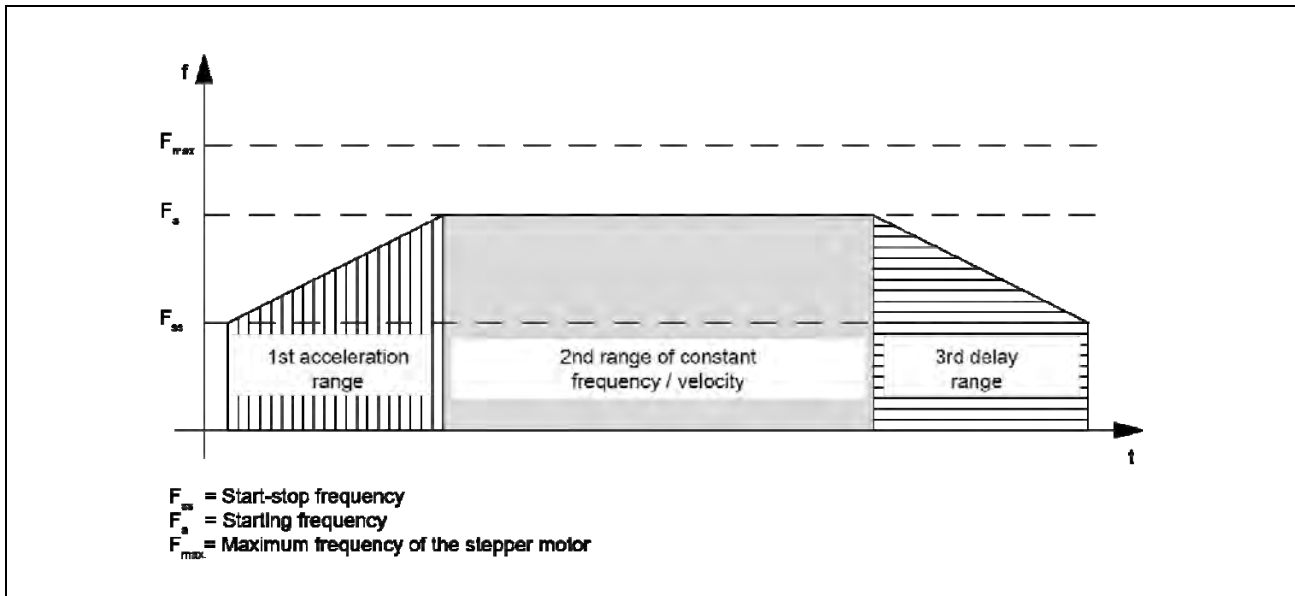

Fig. 21: Traversal curve of the 1-STEP-DRIVE in incremental mode

F_{ss} = Start-Stop Frequency

F_a = Starting Frequency

F_{max} = system-specific, Maximum Frequency of the stepper motor with a load applied

Starting Frequency / velocity F_a

The starting frequency can be chosen for each drive.

If the selected starting frequency is lower than the adjusted Start-Stop frequency F_{ss} , the 1-STEP-DRIVE will default to the Start-Stop Frequency F_{ss} .

F_a is always lower than F_{max} and there should be a safety margin between F_a and F_{max} . Phytron recommends a safety factor from 1.4 to 2.

Setting of the starting frequency / velocity F_a

The Starting Frequency F_a can be set by programming the 1-STEP-DRIVE in stages over 4 parameters:

Therefore, for each traversing job the multiplier G is selected between 1 and 255, which is multiplied by the Base Frequency F_b (4 Hz to 2000 Hz in 9 increments). The Starting Frequency can be reduced further with the Reduction Factor R (1 or 0.1).

The Step Resolution parameter L of the power stage influences the starting frequency. The default value of the step resolution is preselected in the HW-Konfig with $L=1/8$ step. The step resolution can either be changed in the STEP[®]7 parameter list or via data set transfer transmitted to the 1-STEP-DRIVE module if no drive instruction is executed.

If higher resolutions are selected, the whole sum ($F_b \times G \times R$) must be increased by the same amount to allow the stepper motor to rotate at the same velocity.

$$F_a = (F_b \times G \times R)$$

1-STEP-DRIVE Module

Start-Stop Frequency F_{ss}

The start-stop frequency is the frequency to which the motor can be accelerated under load from a standstill without losing the synchronization of the electrical field and also without losing steps.

The maximum Start-Stop Frequency F_{ss} mainly depends on the moment of inertia of the load, as well as from the friction of the system. Since F_{ss} is also the minimum frequency at which the stepper motor can be operated, it is recommended to choose F_{ss} as low as possible.

If the stepper motor must pass through a frequency range in the acceleration phase, the ramp should either be configured as steep as possible to pass through the resonance region quickly and the start-stop frequency should be set above the resonance frequency, or the mechanical system could be damped.

Setting the Start-Stop Frequency F_{ss}

Through parameter assignment, the 1-STEP-DRIVE permits the Start-Stop Frequency F_{ss} to be set in increments. To do so, select the multiplier n between 1 and 255, which is multiplied by the Base Frequency F_b . The Start-Stop Frequency F_{ss} can be lowered again with the Reduction Factor R (1 or 0.1) in the traversing job. As explained in the Starting Frequency F_a the setting of the Step Resolution L has also influences the Start-Stop Frequency.

The Start-Stop Frequency is calculated with the formula:

$$F_{ss} = (F_b \times n \times R)$$

For further information see the following chart “ranges for Start-Stop Frequency, starting frequency and acceleration”.

Maximum Frequency / Velocity of the Axis F_{max}

When choosing a stepping motor, remember the following:

The maximum frequency/velocity is determined by the application. At this frequency, the motor must reach a torque high enough to move its load.

The Maximum Frequency F_{max} can be estimated from the corresponding characteristic curve.

Please note that a sufficiently large safety margin must be applied.

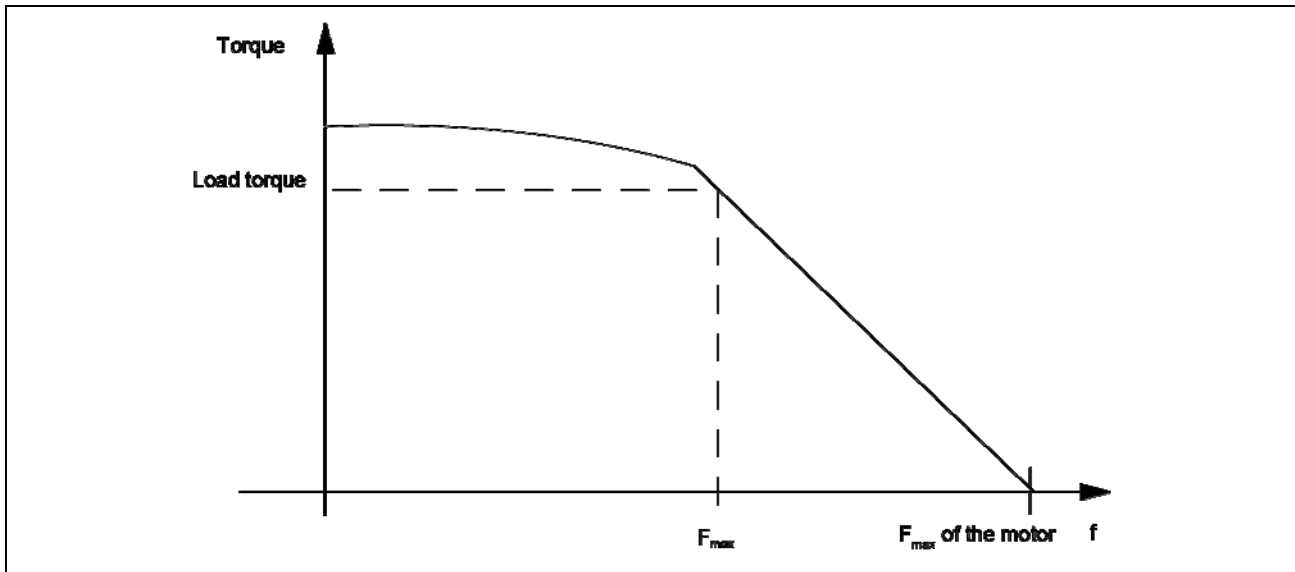

Fig. 22: Torque Characteristic Curve of a Stepping Motor

Acceleration / delay a

The maximum permitted acceleration / delay depends on the load to be moved.

The motor must reach a torque high enough to accelerate or delay the load without loss of step.

Depending on the application, you must also take into account additional criteria for setting the acceleration/delay, such as smooth starting and stopping.

Setting the acceleration / delay a

Through parameter assignment, the 1-STEP-DRIVE permits the acceleration / delay to be set in steps by means of the multiplier i . During the acceleration phase, the frequency is increased continuously starting from the Start-Stop Frequency F_{ss} until the Starting Frequency F_a has been reached.

The time interval for the continuous increase in frequency can be set in steps. For this, a multiplier l is selected from 1 to 255. In the delay phase, the starting frequency is reduced in the same way. You can lower the acceleration / delay a can be lowered further with the Reduction Factor R (1 or 0.1) in the traversing job. The acceleration / deceleration is calculated according to the equation:

$$a = (F_b \times R) / (i \times 0.128 \times 1s \times L)$$

Further information is available in the following table "Areas for Start-Stop Frequency, Starting Frequency and acceleration".

1-STEP-DRIVE Module

8.2 Setting the Base Frequency

Introduction

Through parameter assignment, the 1-STEP-DRIVE permits the base frequency to be set in increments.

The base frequency sets the range for the start-stop frequency, the starting frequency, and the acceleration.

Procedure

1. Depending on the priority of your requirements select a suitable range, either of the Start-Stop Frequency F_{ss} and of the Starting Frequency F_a or of the acceleration a in the following table in accordance with the following criteria:
 - Range for the Start-Stop Frequency F_{ss} ,
for example, for starting and stopping as soon as possible or to skip a resonance frequency
 - Range of the Starting Frequency F_a ,
for example, for a velocity setting that is as precise as possible
 - Range of the acceleration a ,
for example, for the fastest possible positioning operations
2. Use the table to determine the Base Frequency F_b .

To optimize the Base Frequency F_b , proceed as follows:

3. Check whether the other corresponding values meet your requirements. If necessary, select another Base Frequency F_b , which meets your requirements better.
4. Define the multipliers required to set the Starting Frequency F_a , the acceleration / delay a , and the Start-Stop Frequency F_{ss} .
5. Determine the corresponding Reduction Factor R from the table.

Base Frequency F_b in Hz	Reduction Factor R	Range Start-Stop Frequency F_{ss} Starting Frequency F_a in Hz	Range Acceleration a in Hz/s
		Formula: $F_{ss} = (F_b \times n \times R)$ $F_a = (F_b \times G \times R)$	Formula: $a = F_b \times R / (i \times 0.128 \times 1s)$
4	0.1	0.4 ... 102	0.01 ... 3.13
8	0.1	0.8 ... 204	0.02 ... 6.25
20	0.1	2 ... 510	0.06 ... 15.6
4	1	4 ... 1020	0.12 ... 31.3
8	1	8 ... 2040	0.25 ... 62.5
20	1	20 ... 5100	0.61 ... 156
40	1	40 ... 10200	1.23 ... 313
80	1	80 ... 20400	2.45 ... 625
200	1	200 ... 51000	6.13 ... 1563
400	1	400 ... 102000	12.25 ... 3125
800	1	800 ... 204000	24.51 ... 6250
2000	1	2000 ... 510000	61.27 ... 15625

F_b = Base Frequency
 F_{ss} = Start-Stop Frequency
 F_a = Starting Frequency
a = Acceleration / delay
R = Reduction Factor
n = Multiplier for setting the Start-Stop Frequency in steps
G = Multiplier for setting the Starting Frequency in steps
i = Multiplier for setting the acceleration / delay in steps

1-STEP-DRIVE Module

8.3 Functions of the 1-STEP-DRIVE

The task of the 1-STEP-DRIVE is to position a drive on certain predefined targets (incremental modes) and to travel continuously with specifiable frequencies (velocity control mode). In addition a lot of technology parameters of the 1-STEP-DRIVE can be adapted in a way that a final performance of the stepper motor and the customer's drive system is possible. These issues are discussed in detail in subsequent chapters.

8.4 Positioning of the Stepper Motor

8.4.1 Search for Reference

Description of the function

The home position marks the point of reference of the drive system (reference cam) for the following traversing jobs. You can determine the home position by, for example, installing a proximity switch on the reference cam and connecting it to the DI1 digital input. The 1-STEP-DRIVE ensures the reference point can be reproduced accurately in that it is always approached from the same direction. You can specify this direction by always starting the search for reference in the same direction.

Traversing job for reference point approach

The traversing job contains the following information:

- Multiplier G for the Velocity/Starting Frequency F_a
- Reduction Factor R for the assigned parameters Base Frequency F_b
- Reference point position
- Mode = 1 for reference point approach
- Stop at reference cam (see chap. 8.4.7 "Hold Traversing Job")
- Direction selection at Start (see chap. 7.1 and 7.2 "Assignment of the Feedback and Control Interfaces")

i The 1-STEP-DRIVE checks the set position for limits (minimum 0 and maximum 16777215). The full scale value can be configured.

i If the behavior of the digital input DI1 (7) is configured as a "Reference switch and limit switch" (see chap. 8.4.11 "Behavior of the Digital Inputs"), the 1-STEP-DRIVE automatically selects the starting direction toward the limit switch, irrespective of the direction specified in the traversing job.

i Please also note that at each approach of the reference point the Step Resolution L of the power stage has the same parameterization.

Status Bit SYNC

The SYNC status bit indicates you that the axis has been synchronized, that is, after the correct reference point approach is reached the status bit is set and deleted during the run.

The SYNC status bit is deleted:

- After parameter assignment of the ET 200[®]S station
- After deletion of the pulse enable
- After a CPU-/Master-STOP

In these cases it is advisable to carry out a search for a reference point.

POS and POS_RCD status bits

When the reference point approach is active, it is indicated by the set POS feedback bit.

On completion of a reference point approach, the set POS_RCD feedback bit indicates that the position has been reached.

If the reference point approach is interrupted, the POS_RCD feedback bit remains reset.

Residual distance, Position, Frequency

The residual distance reported is irrelevant during the reference point approach (see chap. 7.1 and 7.2 "Assignment of the Feedback and Control Interface").

i In order for the 1-STEP-DRIVE to approach the home position with repeated precision, the period duration of the start-stop frequency has to be greater than the run time of a single step from the 1STEP-DRIVE to the stepping motor and via the reference cam back to 1-STEP-DRIVE. See also "Input delay of the digital inputs" in the chap. 4.2 "Features".

When stopping at the reference cam, or at one of the limit switches during the acceleration phase, the 1-STEP-DRIVE continues to send pulses for a maximum of 50 ms at the frequency already reached before it starts braking. This avoids abrupt changes in frequency, which can lead to step losses.

1-STEP-DRIVE Module

8.4.2 Sequence of Execution of the Search for Reference

Steps of the Search for Reference

A search for reference consists of a maximum of three sections.

In the first section (1) and second section (2), the system ensures that the reference cam is found.

These two sections are traversed at the defined Starting Frequency F_a

In the third section (3), the reference cam is approached with Start-Stop Frequency F_{ss} in the selected direction up to the reference point \oplus with reproducible accuracy.

i The maximum number of output pulses in a section is the set length of the traversing range minus 1.

Various Sequences

Depending on the position \oplus at the start of the reference point approach, there are different execution patterns for the run (REF is the reference cam, which is wired to the DI1 digital input). The illustration applies to the forward starting direction (DIR_P).

LIMIT_M and LIMIT_P are limit switches which are connected to IN0 and IN1. The diagram is for the forward starting direction (DIR_P).

Start before REF

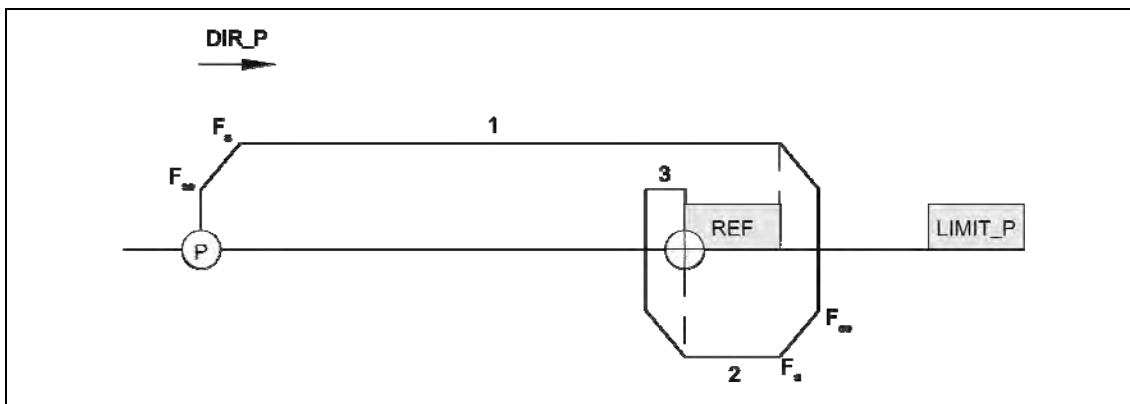

Fig. 23: Reference point approach, start before REF

Start after REF

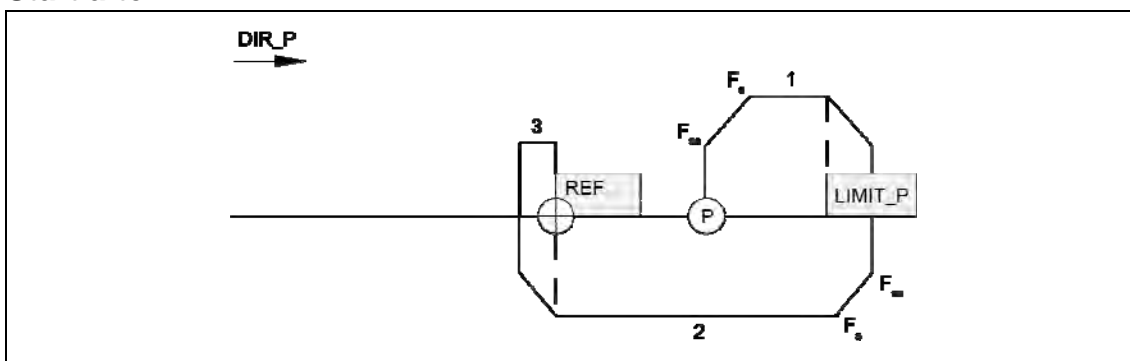

Fig. 24: Reference point approach, start after REF

Start at REF

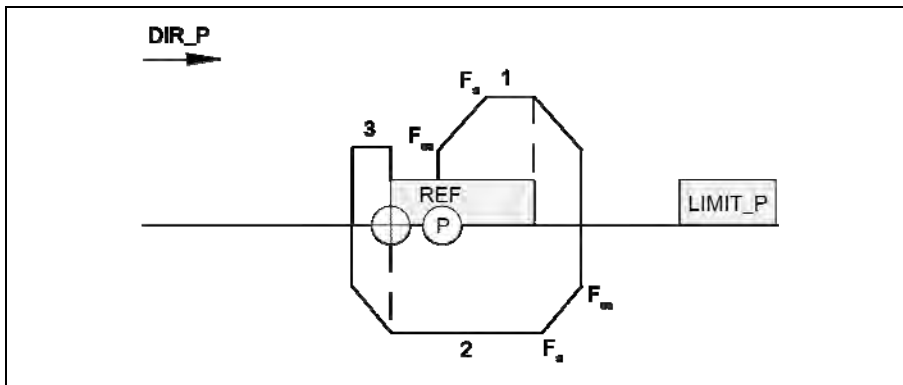

Fig. 25: Reference point approach, start at REF

Start at the limit switch in start direction

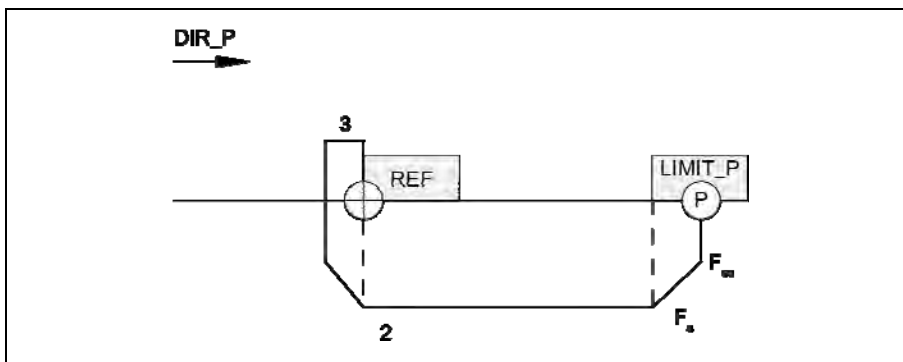

Fig. 26: Reference point approach, start at limit switch in start direction

Example of a traverse by wiring 2 limit switches

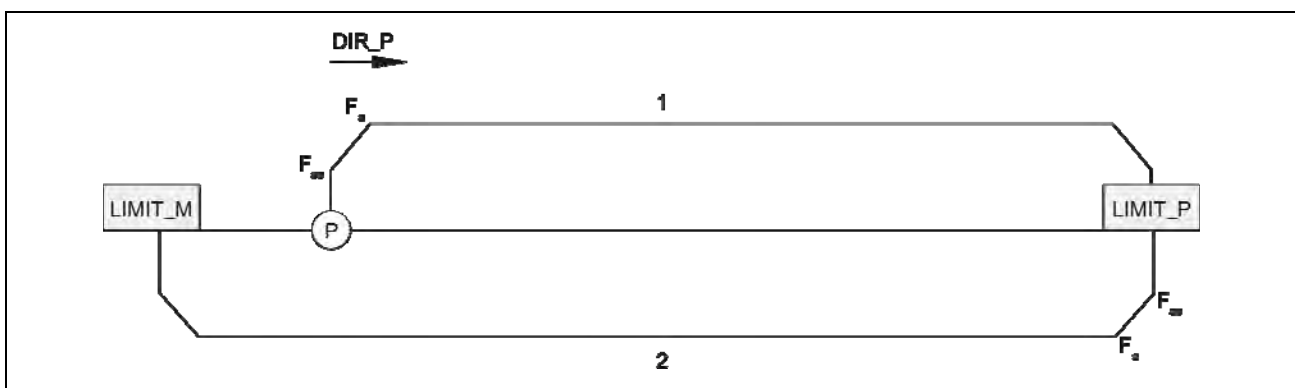

Fig. 27: Start within the allowed traverse range

1-STEP-DRIVE Module



Fig. 28: Start at the limit switch LIMIT_P

Behavior in the case of a constantly set reference cam without limit switch

At the end of the first section, after 16777215 pulses have been output, traversing is terminated with cleared SYNC and POS_RCD status bits.

Response to failure of the reference cam without limit switch

All three sections of traversing are executed, each with output of 16777215 pulses. Afterwards, the search is interrupted with cleared SYNC and POS_RCD status bits.

8.4.3 Set Home Position

Description of the function

The home position marks the reference point of the drive system which the subsequent absolute incremental modes and the position value in the feedback interface reference. The home position is set by specifying the absolute position value for the current position of the stepping motor.

Job for setting the home position

A job for setting the home position is a virtual job without traversing movement. It contains the following information:

- Position of the home position
- Mode = 4 for setting home position
- Any direction specification at start (see chap. 7.1 and 7.2 "Assignment of the Feedback and Control Interfaces")



The 1-STEP-DRIVE checks the set position for limits (minimum 0 and maximum 16777215). The full scale value can be configured.

Feedback messages

The correct execution of the job is indicated by the setting SYNC and POS_RCD feedback bits.

8.4.4 Relative Incremental Mode (Relative Positioning)

Description of the function

The relative incremental mode is used to move the stepping motor a defined distance and thus approach a specified position. The direction of traversing and the velocity from the rest are selectable.

Traversing job for relative incremental mode

The traversing job contains the following information:

- Distance (number of pulses to be sent)
- Multiplier G for the Velocity / Starting Frequency F_a
- Reduction Factor R for the assigned parameters Base Frequency F_b
- Mode = 0 for incremental mode, relative
- Stop at reference cam (see chap. 8.4.7 "Hold Traversing Job")
- Direction selection at start (see chap. 7.1 and 7.2 "Assignment of the Feedback and Control Interfaces")

i The 1-STEP-DRIVE checks the specified distance for limits (minimum 1 and maximum 16777215 pulses). The distance to the limit switch is not checked by the 1-STEP-DRIVE. Traversing is stopped at the latest when the limit switch is reached.

i Make sure that the Step Resolution L, which is parameterized in the power stage of the 1-STEP-DRIVE, also influences the Starting Frequency F_a but is not transmitted with the traversing instruction. See also chap. 8.1 "Traversing Curve of the 1-STEP-DRIVE".

Feedback messages

The POS_RCD feedback bit is reset at the beginning of incremental mode.

While the incremental mode is active, it is indicated by the set POS feedback bit.

After incremental mode has been correctly executed, the set POS_RCD feedback bit indicates that the position has been reached.

If the incremental mode is interrupted, the POS_RCD feedback bit remains reset. After incremental mode has been stopped, the distance still to be traversed is displayed if the feedback value is set to "Residual distance" (see chap. 7.1 and 7.2 "Assignment of the Feedback and Control Interfaces").

1-STEP-DRIVE Module

8.4.5 Absolute Incremental Mode (Absolute Positioning)

Description of the function

The absolute mode is used to move the stepping motor to a defined position and thus approach a specified position.

The velocity is specified at the start. The direction and the distance of traversing are determined automatically by the 1-STEP-DRIVE on the basis of the starting position (actual position value). The direction for a modulo axis can be specified.

i Setting Forward start and Backward start (DIR_P and DIR_M) simultaneously for a modulo axis results in the 1-STEP-DRIVE automatically selecting the shortest distance to reach the target position (see chap. 8.4.8 "Axis Type and Traversing Range").

Traversing job for absolute incremental mode

The traversing job contains the following information:

- Target position
- Multiplier G for the Velocity/Starting Frequency F_a
- Reduction Factor R for the assigned parameters Base Frequency F_b
- Mode = 2 for incremental mode
- Any direction specification at start (see chap. 7.1 and 7.2 "Assignment of the Feedback and Control Interfaces")

i The 1-STEP-DRIVE checks the set position for limits (minimum 0 and maximum 16777215). The full scale value can be configured.

The traversing job is only executed if you have determined or specified the position of the home position beforehand (the SYNC bit has to be set, see chap. 8.4.1 "Search for Reference" or chap. 8.4.3 "Set Home Position")

The control signal "Hold at reference cam" is not taken into consideration (see chap. 7.1 and 7.2 "Assignment of the Feedback and Control Interfaces").

i Make sure that the Step Resolution L, which is parameterized in the power stage of the 1-STEP-DRIVE has an influence on the Starting Frequency F_a but is not transmitted with the traversing instruction. See also in chap. 8.1 "Setting of the starting frequency F_a ".

Feedback messages

The POS_RCD feedback bit is reset at the beginning of incremental mode.

While the incremental mode is active, it is indicated by the set POS feedback bit.

After incremental mode has been correctly executed, the set POS_RCD feedback bit indicates that the position has been reached

If the incremental mode is interrupted, the POS_RCD feedback bit remains reset. After incremental mode has been stopped, the distance still to be traversed is displayed if the feedback value is set to "Residual distance" (see chap. 7.1 and 7.2 "Assignment of the Feedback and Control Interfaces").

8.4.6 Velocity Control Mode

Description of the function

This operating mode specifies the frequency with which the pulses (steps) are output. When the frequency is changed, the pulses are output with the new frequency after an acceleration or deceleration phase. The output is carried out continuously until either stopping the traversing job or a traversing range is reached in a linear axis.

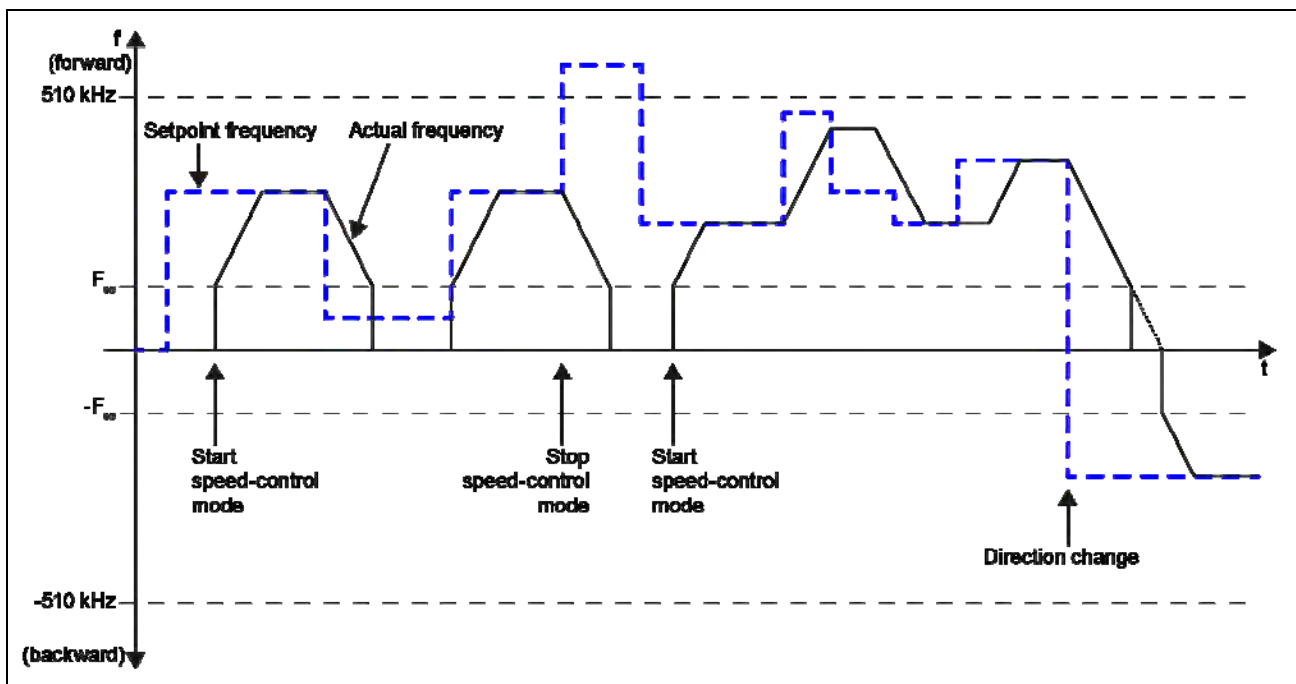

Fig. 29: Velocity control mode with modulo axis

1-STEP-DRIVE Module

Traversing job for velocity control mode

The traversing job contains the following information:

- Setpoint frequency as 32 bit value (STEP[®]7 data type REAL)
- Direction specification by the sign of the setpoint frequency (positive: forward)
- Mode = 3 for velocity control mode
- Any direction specification at start (see chap. 7.1 and 7.2 “Assignment of the Feedback and Control Interfaces”)



The 1-STEP-DRIVE checks the set position for limits (minimum -510.0 kHz and maximum +510.0 kHz).

The specified frequency is approached with the configured acceleration under consideration of the Start-Stop Frequency F_{ss} . No pulse output is sent at frequencies that are less than F_{ss} .

The continuous output of the frequency is terminated by the following events:

- Reaching of the limits of the configured traversing range (0 in the direction backward) unless a modulo axis is configured
- Other aborting conditions for traversing jobs (see chap 8.4.7. “Hold Traversing Job”).

Feedback messages

While the traversing job is active, it is indicated by the set POS feedback bit.

When a new frequency is specified, the POS_RCD feedback bit is cleared. When the new frequency has been reached after the acceleration or deceleration phase, POS_RCD is set again.

The current frequency is displayed in the feedback interface as a 32 bit value (STEP[®]7 data type REAL) if the feedback value is set to “Frequency” (see chap. 7.1 and 7.2 “Assignment of the Feedback and Control Interfaces”).

8.4.7 Hold Traversing Job

Specific holding of the traversing job

- Caused by	Displayed by Feedback Bit
STOP by control bit	-
External STOP at digital input	STOP_EXT
Limit switch in the forward direction reached (LIMIT_P or digital input)	STOP_LIMIT_P
Limit switch in the backward direction reached (LIMIT_M or digital input)	STOP_LIMIT_M
STOP at the reference cam	STOP_REF

i Remember that the limit switches are also used in the reference point approach mode to search for the reference cam.

Stop at the reference cam

If the “Hold at reference cam” function is selected (the control bit STOP_REF_EN is set) at the start of traversing and the reference cam is detected during traversing, the stepping motor is halted and traversing is terminated.

Holding the traversing job in exceptional circumstances

In the following cases the traversing job is halted with loss of the synchronization:

- Incorrect operation in the control interface during an active traversing job
- CPU/Master-Stop
- On linear axis: Reaching the limit of the traversing range

Effects

If one of the above reasons for holding the current positioning operation occurs, it is terminated with a deceleration ramp.

The return value continues to be updated even when the traversing job is halted in exceptional cases. This enables traversing the residual distance after holding by means of a new traversing job in the “Relative incremental mode”.

1-STEP-DRIVE Module

Limit Switches and External STOP

By assigning parameters, there are choices to wire normally open or normally closed contacts for the external STOP and the limit switches.

Normally closed contact means: The external STOP and the effect of the limit switches are triggered by a 0 signal. When the limit switches are reached, delete the associated control bit.

Normally open contact means: The external STOP and the effect of the limit switches are triggered by a 1 signal. When the limit switches are reached, set the associated control bit.

i In case of holding during the acceleration phase the 1-STEP-DRIVE continues to send pulses for a maximum of 50 ms at the frequency already reached before it starts braking. This avoids abrupt changes in frequency, which can lead to step losses.

8.4.8 Axis Type and Traversing Range

Overview

During configuration, the axis type to be controlled is specified by the stepping motor controlled by 1-STEP-DRIVE. There is a choice of the following types of axes:

- Linear axis
- Modulo axis

Description of the function

Linear axis

The traversing range of a linear axis can be set. The low limit is always 0, the high limit is configured and has a value range of 1 to 16777215. The traversing range can be limited further by limit switches (working range).

Modulo axis

A modulo axis is a particular form of the rotary axis.

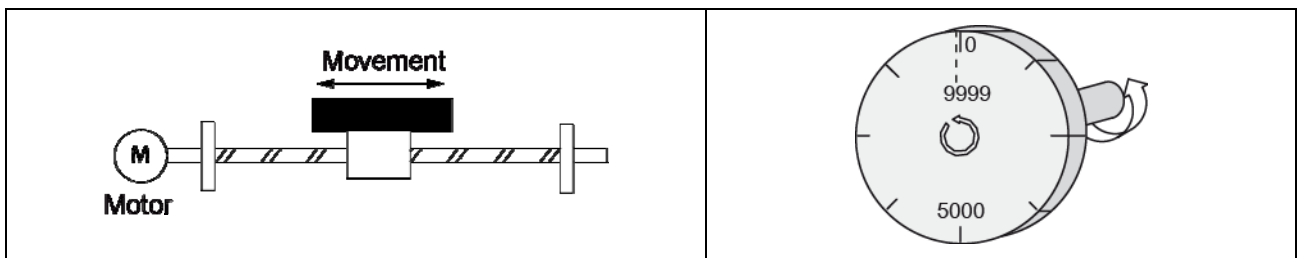

Fig. 30: Linear axis

Fig. 31: Modulo axis

End of the modulo axis

The “Traversing range” parameter is used to specify the end of the modulo axis.

The actual position value cannot reach the traversing range value, because this highest value lies physically at the same position as the start of the modulo axis (0).

Example:

Specifying the value 10000 as the traversing range, see figure above.

During a forward movement the position value jumps in the feedback interface from 9999 to 0, during a backward movement from 0 to 9999.

Reference point approach

If a modulo axis is selected during the configuration being assigned as a reference cam to the drive system, a reference point approach can be performed (see chap. 8.4.1 “Search for Reference”).

Traversing is aborted unsuccessfully if the reference cam is not found after the output of a number of pulses that corresponds to the configured traversing range. The SYNC and POS_RCD status bits then remain deleted.

Set home position

Only specify values from 0 to the end of the configured end of the traversing range – 1 for the position of the home position.

Relative positioning

The end of the traversing range (end of the modulo axis) may be exceeded in both directions.

Absolute positioning

Selecting the modulo axis during the configuration, allows specifying values only from 0 to the configured end of the traversing range to – 1 for the target position.

In contrast to the linear axis the direction specification is chosen when the traversing job is started to reach the target position (see chap. 7.1 and 7.2 “Assignment of the Feedback and Control Interfaces”):

- Backward start (DIR_M): The 1-STEP-DRIVE approaches the target position in the direction of lower actual position values (Option 1 in the following figure).
- Forward start (DIR_P): The 1-STEP-DRIVE- approaches the target position in the direction of the higher actual position values (Option 2 in the following figure).
- Forward start and backward start simultaneously (DIR_P and DIR_M): The 1-STEP-DRIVE automatically selects the shortest path for reaching the target position (Option 1 in the following figure).

1-STEP-DRIVE Module

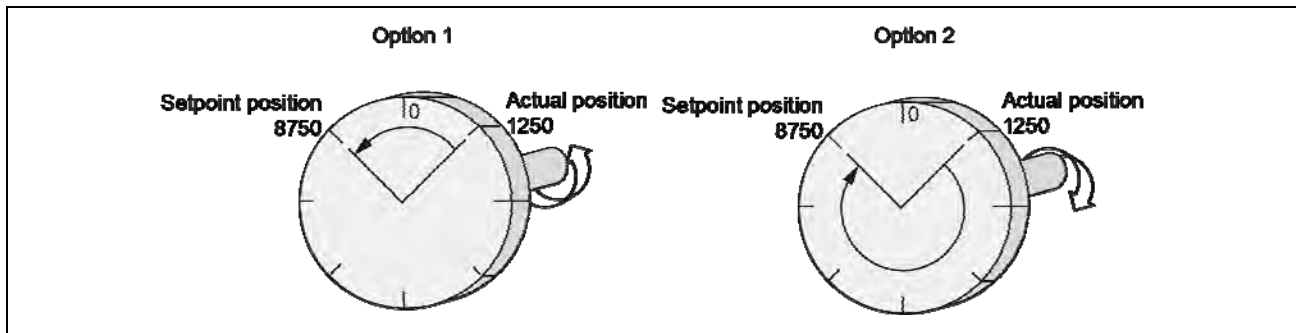

Fig. 32: Absolute incremental mode with modulo axis

8.4.9 Pulse Enable

Description of the function

Pulse enable permits the output of pulses from the 1-STEP-DRIVE to the power unit. A run is not possible without pulse enable.

Activating Pulse Enable

Pulse enable is activated by one of the following methods:

- Through the digital input DI0 when “Function DI0” is configured as an external pulse enable (see chap. 8.4.11 “Behavior of the Digital Inputs”)
- or
- Through the control bit DRV_EN when the “Function DI0” is configured as an external STOP or limit switch forward or backward (see chap. 8.4.11 “Behavior of the Digital Inputs”)

You can recognize the assigned pulse enable through the fact that

- The RDY LED at the 1-STEP-DRIVE light is on in case of correct configuration.
- The STS_DRV_EN feedback bit is set.



The function “Pulse enable” is not a safe mode according to IEC61800-5-2 such as “Safe Torque Off” (STO) by pulse pattern lock-out.

Deleting the Pulse Enable

Deleting the pulse enable during a run terminates the run immediately because no more pulses are sent to the power unit. The residual distance and actual position value are no longer valid. The synchronization of the axis by means of the reference point is lost. The SYNC feedback bit and the RDY LED are deleted.

Deleting the pulse enable when the motor is at standstill deletes the SYNC feedback bit and the RDY LED.

In this case it may be necessary to carry out a reference point approach.

8.4.10 Changing Positioning Parameters during Operation

Introduction

You can change several of the 1-STEP-DRIVE parameters during operation without having to reassign the parameters of the whole ET 200[®]S station.

Parameters that Can Be Changed

The following parameters can be changed:

- Base Frequency F_b
- Multiplier n for Start-Stop Frequency F_{ss}
- Multiplier i for acceleration / delay
- Feedback value in the feedback interface

When changing parameters by means of the C_PAR control bit, the parameters are checked for permitted values (see chap. 6.2.2 "Parameter Assignment"). If invalid values are entered, the ERR_JOB feedback bit is set.

Only the feedback bits for the ERR_JOB and STS_JOB job processing are affected by the configuration job.

1-STEP-DRIVE Module

8.4.11 Behavior of the Digital Inputs

Introduction

The function and the behavior (active level) of the digital inputs IN0 (3) and IN1 (7) can be configured. These parameters cannot be changed using the user program.

Digital input IN0 (3)

The function of the digital input IN0 (3) can be configured as:

- An external pulse enable
- An external STOP
- Limit switch in the forward direction
- Limit switch in the backward direction

The behavior of the digital input IN0 (3) can also be configured as:

- Normally closed contact
- Normally open contact

Digital input IN0 (3) as an external pulse enable

The input must be put into operation (activated). If the input is set and the configuration correct, the 1-STEP-DRIVE is ready for operation (see chap. 8.4.9 “Pulse Enable”).

Digital input IN0 (3) as external STOP

With this input function, a current transverse job can be halted by means of an external signal (see chap. 8.4.7 “Hold Traversing Job”).

Digital input IN0 (3) as a limit switch in the direction forward or backward

With these input functions, the traversing range in the forward or backward direction is limited by an external signal. The signal has the same effect as one of the two control bits LIMIT_P or LIMIT_M in the control interface (see chap. 7.1 and 7.2 “Assignment of the Feedback and Control Interfaces”).

Digital input IN1 (7)

The function of the digital input IN1 (7) can be configured as:

- A reference switch (reference cam)
- This parameter selection is only possible if “Function IN0” is not configured as a “Limit switch forward”.
- Reference switch and limit switch in the backward direction This parameter selection is only possible if “Function IN0” is not configured as a “Limit switch backward”.

The behavior of the digital input IN1 (7) can also be configured as:

- Normally closed contact
- Normally open contact

Digital input IN1 (7) as a reference switch

A switch to this input can be wired for the reference cam.

A reference cam is needed for the following:

- For a reference point approach
- For an incremental mode with holding on the reference cam.

Digital input IN1 (7) as a reference switch and limit switch in the direction forward or backward

With these input functions, the traversing range can also be limited in the forward or backward direction through the reference cam. Additionally, the signal has the same effect as one of the two control bits LIMIT_P or LIMIT_M in the control interface (see chap. 7.1 and 7.2 “Assignment of the Feedback and Control Interfaces”).

8.4.12 Behavior at CPU-Master-STOP

Introduction

The 1-STEP-DRIVE detects the CPU/master STOP. It reacts to this by stopping the active traversing job (see chap. 8.4.7 “Hold Traversing Job”).

Exiting the CPU-Master-STOP Status

ET 200 [®] S station	1-STEP-DRIVE
Without reconfiguration of the ET 200 [®] S station	<ul style="list-style-type: none"> • The feedback interface of the 1-STEP-DRIVE remains current. • The values changed by means of parameter assignment job are maintained. • If a control bit was set (DIR_P, DIR_M, C_PAR) when the CPU/master STOP occurred, the bits STS_JOB and ERR_JOB are set when the CPU/master STOP status is exited. Delete the control bit. Traversing / the parameter assignment job is not executed. A new traverse can be started by means of the control bit. • After the delay ramp, the pulse enable, the RDY LED, and the SYNC status bit are deleted.
With reconfiguration of the ET 200 [®] S station	<ul style="list-style-type: none"> • Information on previous searches and parameter assignment jobs is reset. • If pulse enable was activated by means of the control bit DRV_EN at the time of the CPU/master STOP, the pulse enable, the RDY LED, and the SYNC status bit are deleted after the delay ramp.

Reconfiguration of the ET 200[®]S station

1-STEP-DRIVE Module

Reconfiguration of the ET 200[®]S station is carried out by the CPU/ DP master at:

- POWER ON of the CPU / DP master
- POWER ON of the IM 151 / IM 151 FO
- After failure of the DP transmission
- Upon loading changed parameters or configuration of the ET 200[®]S station into the CPU / DP master
- When the 1-STEP-DRIVE is connected
- Upon power on or inserting of the appropriate power module

See also “Pulse Enable” (chap. 8.4.9)

8.5 Functions of the Integrated Power Stage

It is possible to parameterize both the positioning orders and also the technology parameters of the integrated power stage. These parameterizations are defined once and not with each traversing job. The parameters of the power unit are transferred in the asynchronous interface of the data set transfer.

Thus, the technology parameters cannot be changed synchronously with the control and feedback interface, but always while CPU RUN, if no traversing job is available on the 1-STEP-DRIVE.

This guarantees that the power stage can be adjusted perfectly for its task before each traversing job, if it is required by the drive system. For example increase the stop current if the motor must hold a load and reduce the current once the system is stationary without a load in order to minimize power consumption and motor heating. These parameters are available at any time to get the best out of the 1-STEP-DRIVE and therefore of the drive system.

8.5.1 Phase Currents (Run, Stop, Boost Current)

Three different phase currents can be indicated for the 1-STEP-DRIVE: run current, stop current and boost current.

The run current is the one that is produced at a constant velocity (F_a) during the run mode. After the motor is brought to a stop we recommend switching to a reduced stop current after a parameterized Run Current Delay Time (t_{DELAY}). This reduces the thermal losses of the motor at standstill and saves power consumption.

While a stepper motor is accelerated or decelerated, it needs more torque and thus more power compared to a pure run with a constant velocity (F_a). The torque can then be increased in the phases of acceleration and deceleration.

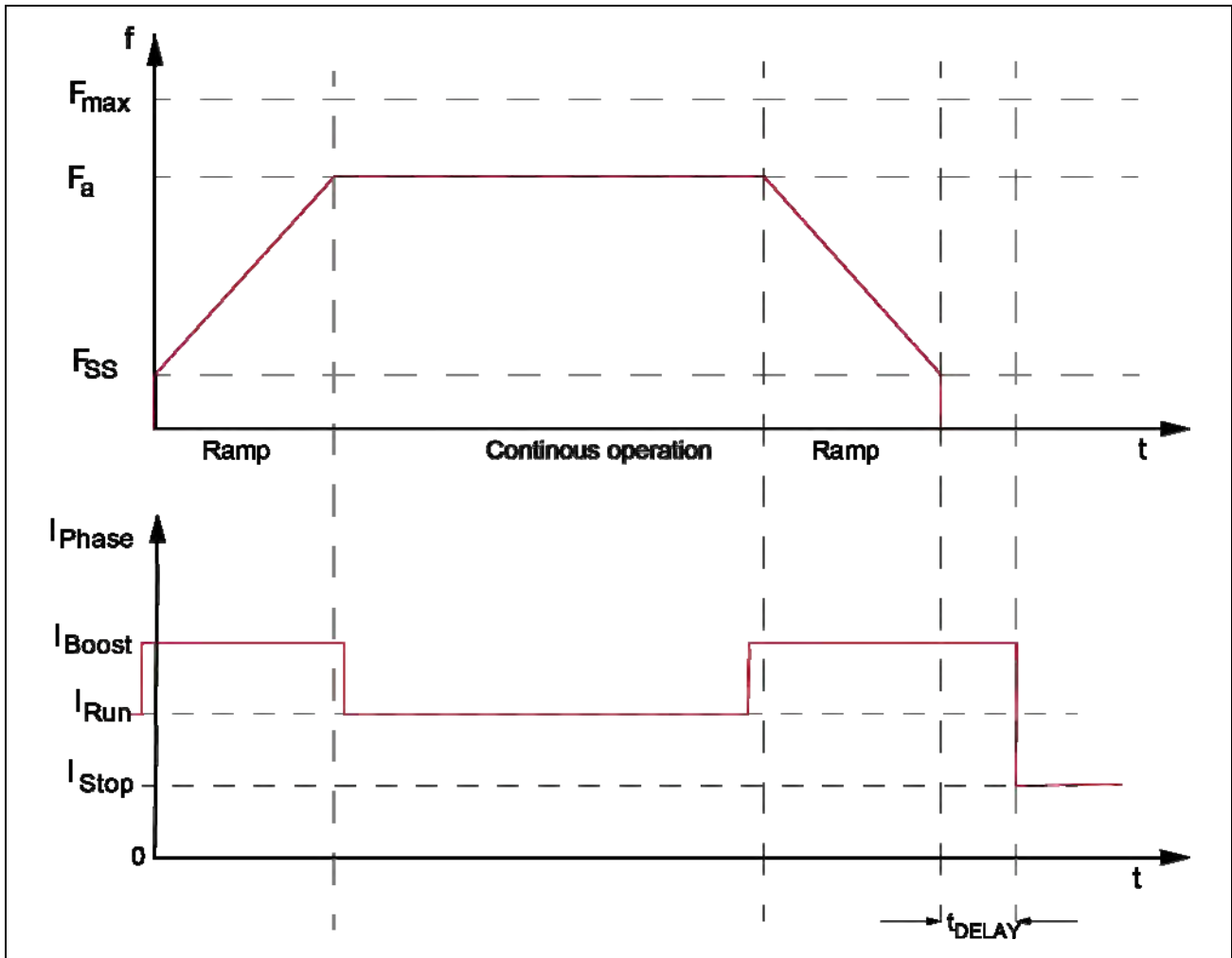

Fig. 33: Traversal curve versus current adjustment at the power stage

During the acceleration/deceleration phases it is automatically switched to the Boost Current I_{BOOST} . According to a time set in the parameter "Run Current Delay Time" t_{DELAY} it will be switched to Stop Current I_{STOPP} after the run is finished.

8.5.2 Preferential Direction

The motor direction can be reversed by setting the corresponding bit.

1-STEP-DRIVE Module

8.5.3 Chopper Frequency

The chopper frequency is generated in the power unit in the double digits kHz range to regulate to the current to its set value. By default this is preset to 20 kHz and can be set at the 1-STEP-DRIVE from 18 kHz to 25 kHz in 4 stages.

The chopper frequency has in certain velocity ranges, an effect on the quietness, the resonance and also on the generated torque of the motor. In particular, resonance effects can occur with load angle variations and asynchronous operations between the chopper frequency and the stepper motor frequency. For these cases the chopper frequency of the power stage can be changed. Even if this method does not sufficiently enhance the described effects, resonances can be eliminated by an external damper system at the rear shaft of the stepper motor.

8.5.4 ODIS Behavior

The behavior of the 1-STEP-DRIVE in case of applied ODIS (Output Disable) signals can be predefined, depending on what is more convenient for the system.

Set the ODIS behavior to “disable power stage”, if the drive should be without current in the case of ODIS and therefore without torque.

Set “stop current of the power stage”, if the drive should be holding with stop current in case of an applied ODIS signal.

i The ODIS behavior “disable power stage“ or “stop current of the power stage“ is not a safe mode according to IEC61800-5-2 such as “Safe Torque Off” (STO) or similar. They are only aids to increase confidence in the system’s performance.

8.5.5 Step Resolution

Full step

The “full step” mode is the operating mode in which a 200-step motor, for example, drives 200 steps per revolution. The physical resolution of the motor is achieved in the full step mode. Any further increase of the step resolution (e. g. half step, quarter step, etc.) is done electronically. In the full step mode, both stepper motor phases are permanently energized.

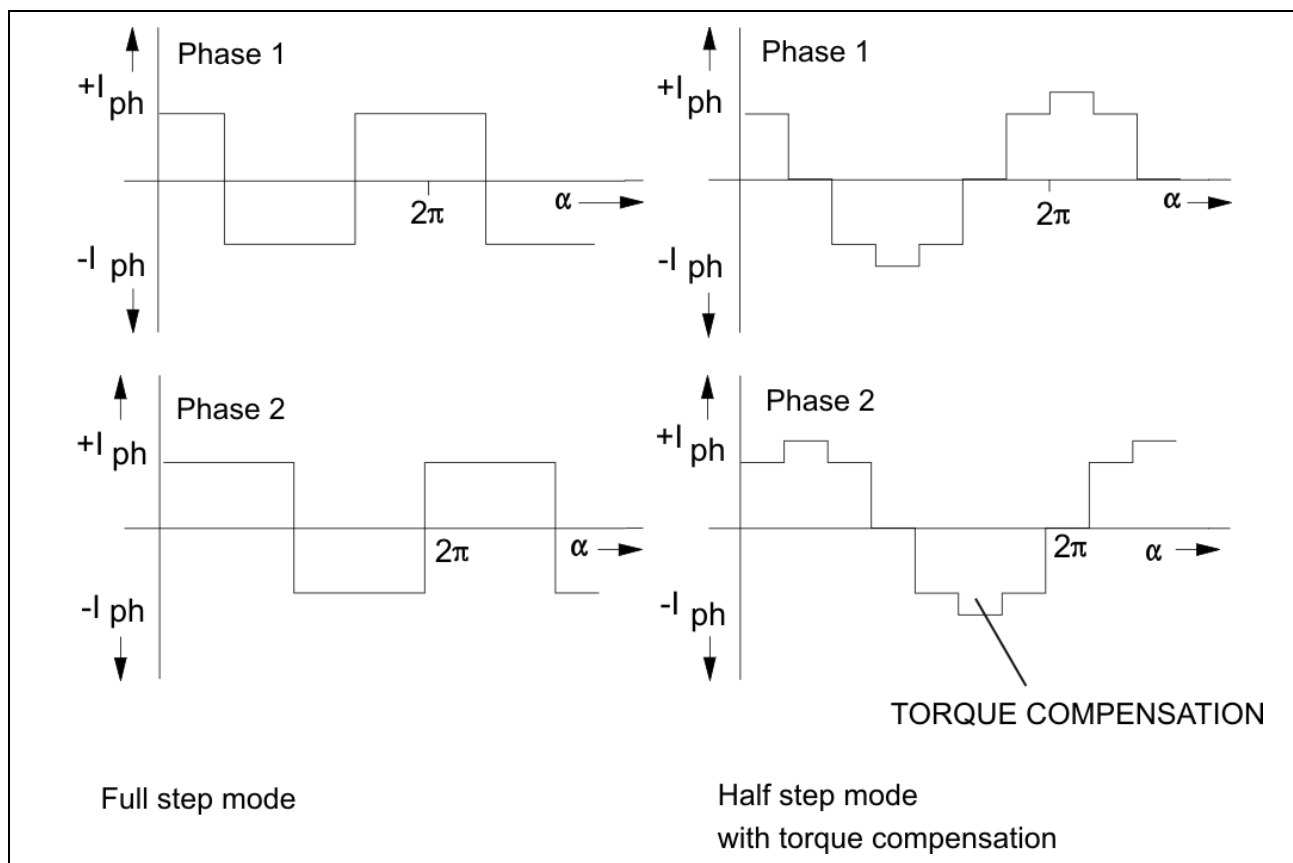

Fig. 34: Phase current curves

1-STEP-DRIVE Module

Half step

The motor step resolution can be electronically multiplied by 2 by alternately energizing the stepper motor's phases 1, 1+2, 2 etc. This is the "half step" mode. The torque, however, is reduced in the half step mode, compared to the full step mode.

To compensate for this lack of torque, the operating mode "half step mode with torque compensation" was developed: the current is increased by $\sqrt{2}$ in the energized phase. Compared to the full step mode, the torque delivered is almost the same and most of the resonance is suppressed.

The following diagram shows the magnitude and direction of the holding torques of a 4 step motor during one revolution without and with torque compensation. In the full step position two phases are energized, in the half step position only one phase is energized. The total torque is the result of the vector sum for any phases that are energized.

The Torque Full Step, M_{FS} , as compared to the torque in the half-step mode is: $|M_{FS}| = |M_{HS}| \times \sqrt{2}$

This means, when a single phase is energized, the current must be increased by a $\sqrt{2}$ factor to obtain an identical torque.

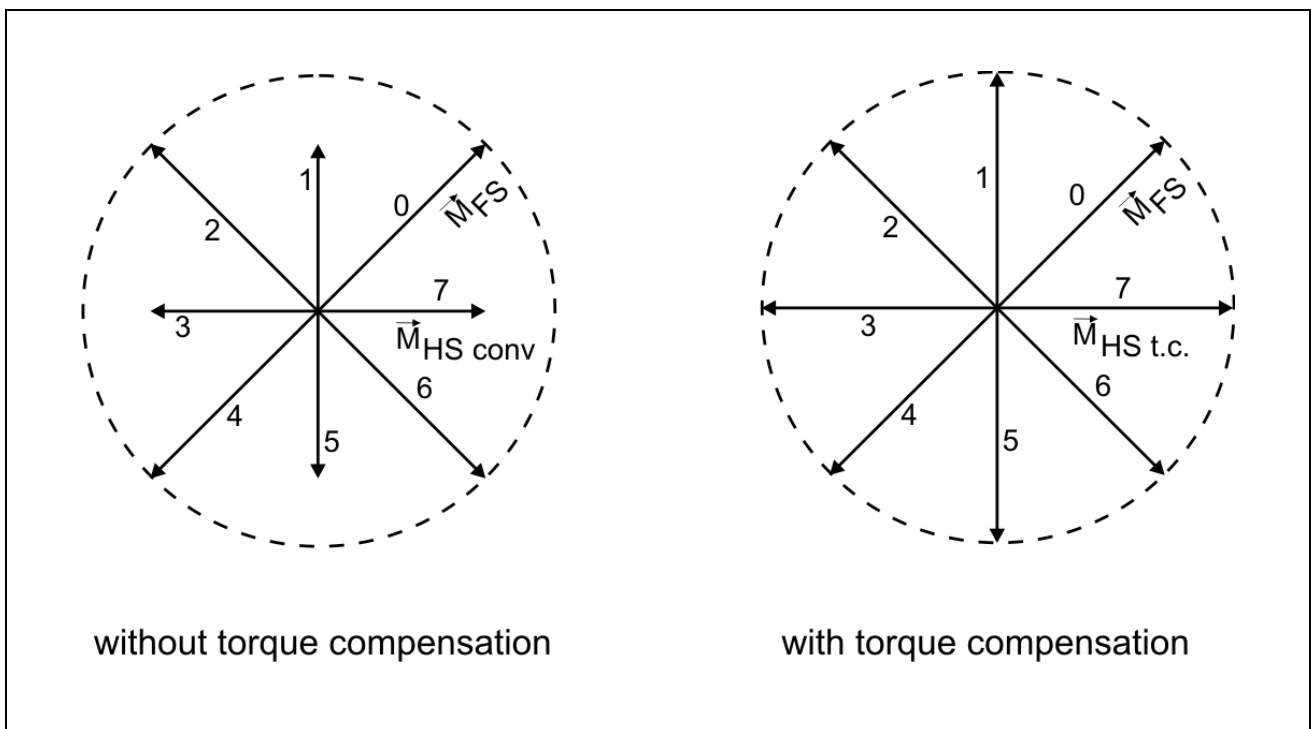

Fig. 35: Holding torques without/with torque compensation

Micro step

The step resolution of the 1-STEP-DRIVE can be increased electronically to 1/512 of a full step. A 200 step motor can, in theory, be commanded to one of 102,400 positions (equal to 0.0035° per move pulse) per revolution.

Various advantages are obtained with the micro step mode:

- The torque undulation drops when the number of micro steps is increased.
- The achievable torque can increase up to 1/8 step, also a further increase of the resolution does not increase torque.
- Resonance and overshoot phenomena are greatly reduced; the motor operation is almost resonance-free.
- The motor noise also drops when the number of micro steps is increased.

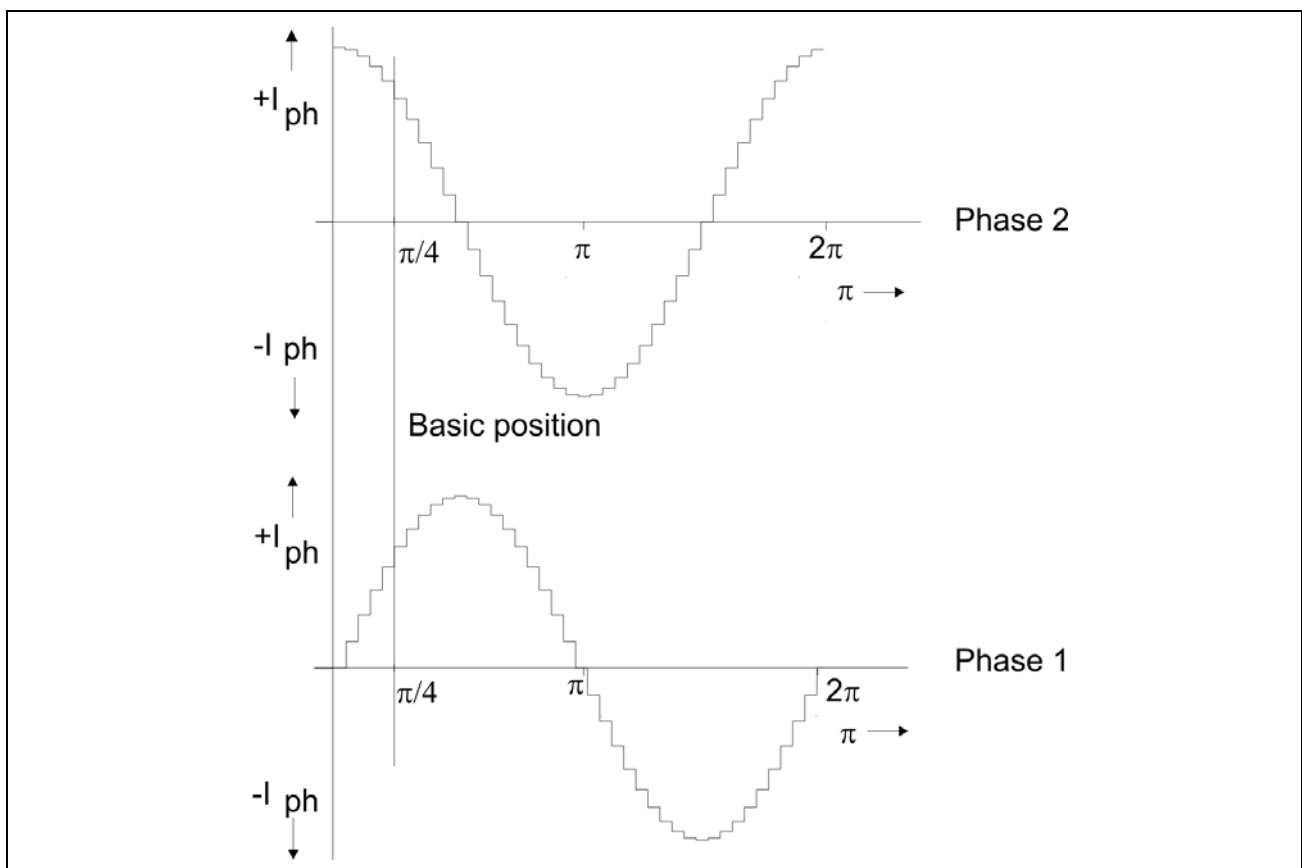
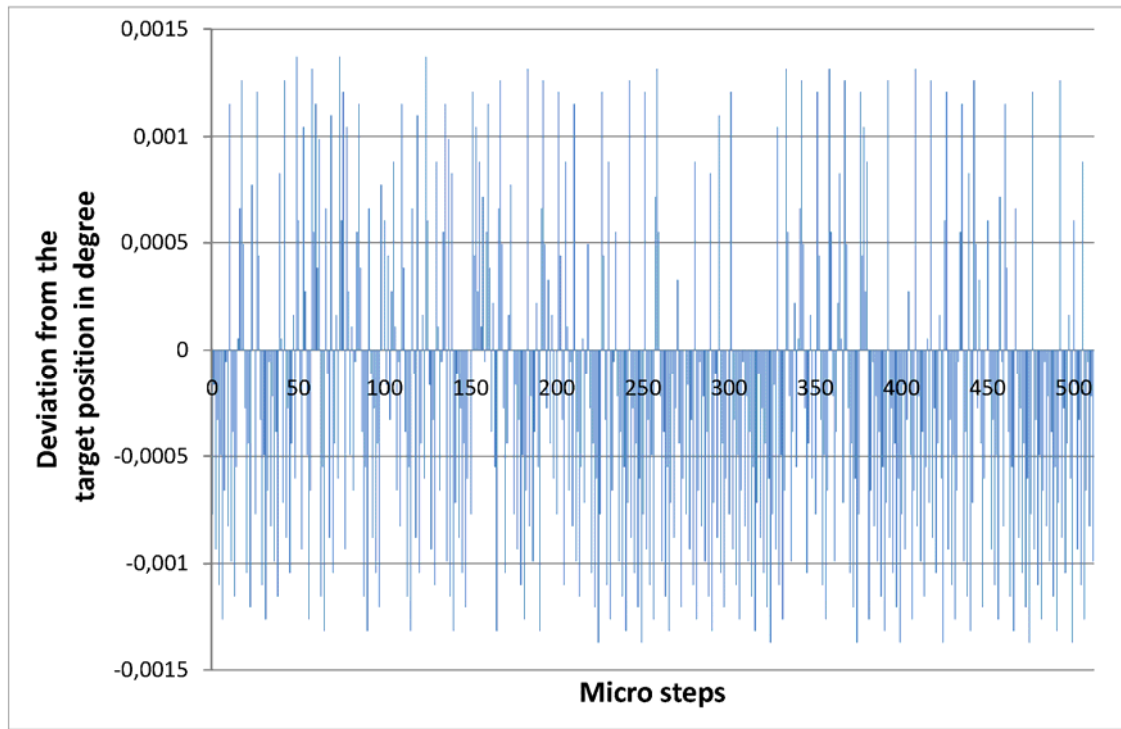

Fig. 36: Schematic profile of the phase currents with 1/10 micro step (of a full step)

i If using the highest micro step settings to perform accurate and absolute precision positioning, then use also a counter module with an attached encoder in order to achieve this. Then you can ensure the achievement of the target position or readjust if necessary. Even the slightest mechanical failure in the stepper motor can cause an incorrect micro step. The accuracy of the current setting of the 1-STEP-DRIVE is high enough to dissolve even 1/512 step electrically safe.

1-STEP-DRIVE Module



8.5.6 Current Delay Time

After the last control pulse, the stop current is activated after a set time to minimize power consumption and motor heating. The time after the last control pulse until changing to the stop current is called Current Delay Time.

Phytron recommends specifying t_{Delay} so that the motor's oscillations are decaying after the last motor step and positioning is more accurate. The higher current reduces in this case the decay and incorrect positioning are avoided.

A value of 1 to 1000 ms can be adjusted in 15 stages.

Automatic change from run to stop current:

After the stop current is applied, the ratio between both phase currents remains the same in the respective current feed pattern. Changing from run to stop current is achieved synchronously.

In the following figure the next motor step follows after every **rising** control pulse edge:

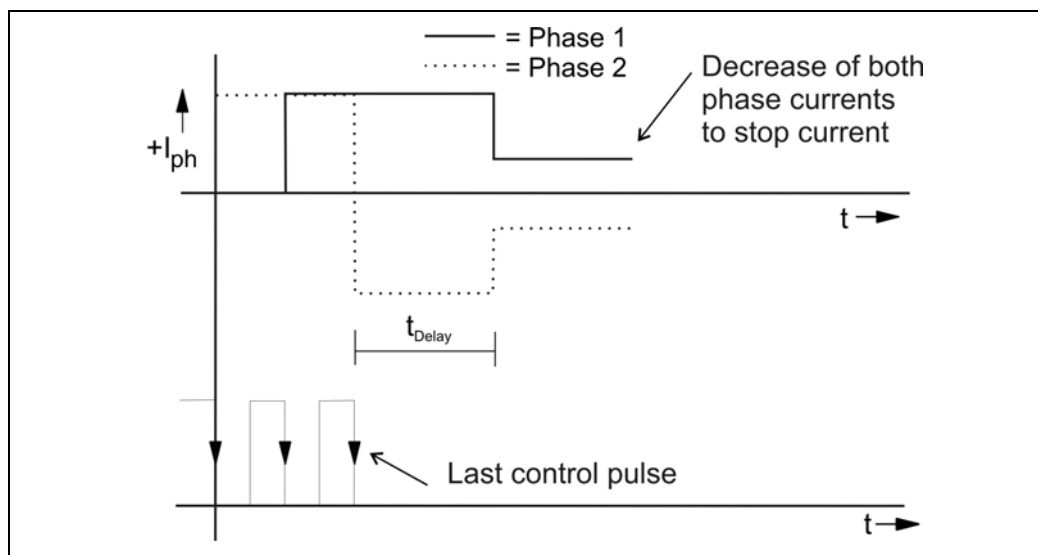

Fig. 37: Decrease to stop current after the last control pulse (full step)

Decreasing to stop current has the following advantages:

- Motor and power stage heating and power consumption is reduced.
- EMC is further improved due to smaller current values at a standstill.

The Current Delay Time t_{DELAY} after the last step of a traversing job has the following advantages:

- The release time of the stepper motor at its target position will be accelerated. So the next traversing job can be started quicker.
- Step loss, therefore incorrect positioning, by decaying effects on reaching a position is minimized.

1-STEP-DRIVE Module

8.5.7 Overdrive

The Overdrive function affects a compensation of the phase current decrease, that is seen when driving in the upper speed range, it is independent of the motor type

Overdrive is a dynamic boost function which is switched on automatically.

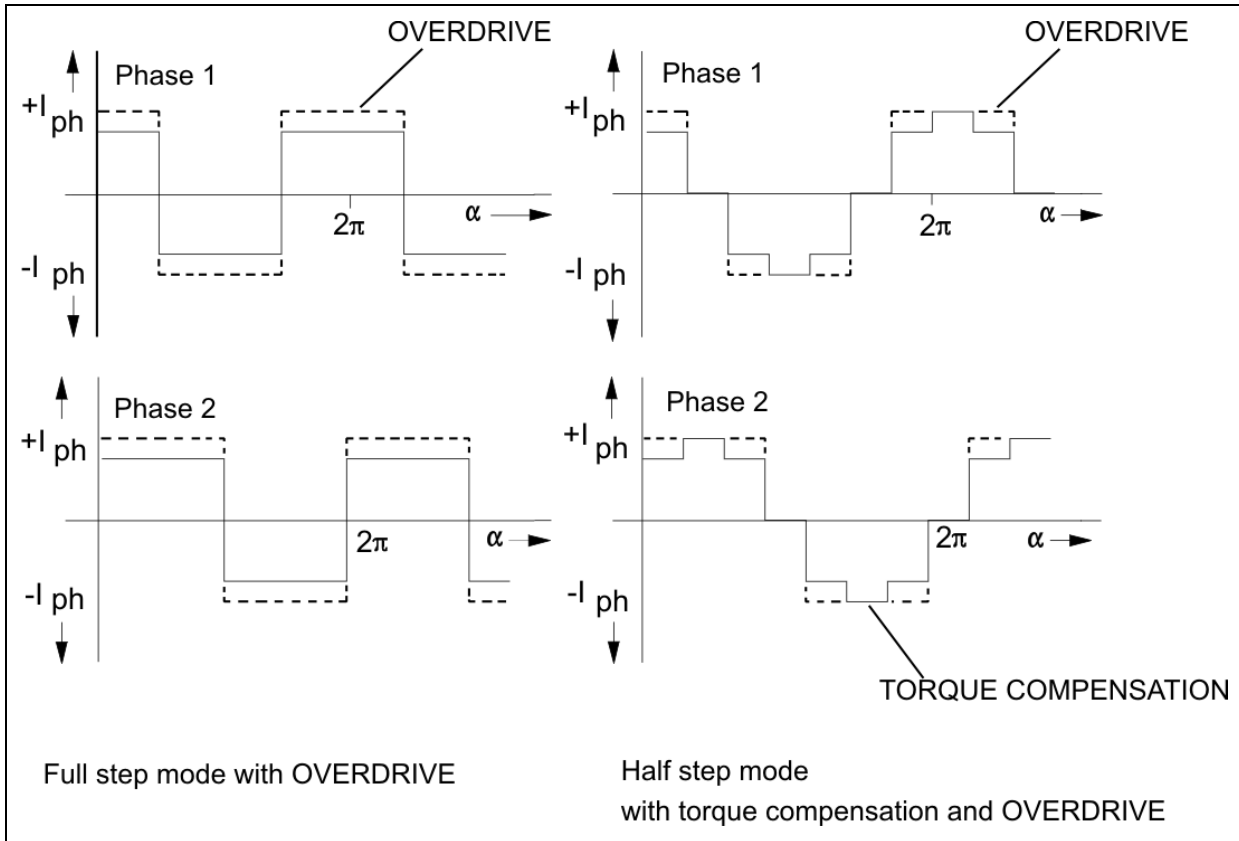

Fig. 38: Overdrive

The stepper motor phase current decreases with rising step frequency caused by the motor's regenerative action. The amplitude of the current curve becomes lower and the motor loses torque.

The Overdrive function counteracts this by automatically raising the effective phase current by a factor of $\sqrt{2}$ (generating a step curve). It compensates for the decrease of the torque. If the speed falls, the Overdrive is switched off automatically.

The Overdrive of the 1-STEP-DRIVE can be either eliminated entirely or selected in 7 increments from 1 kHz to 20 kHz. By default, a switch on threshold of 8 kHz is preselected.

8.5.8 Basic Position

The signals are generated when the internal ring counter passes through zero, after the unit is powered and after a reset

Both motor phases are energized by the same current value in basic position independent of the step resolution.

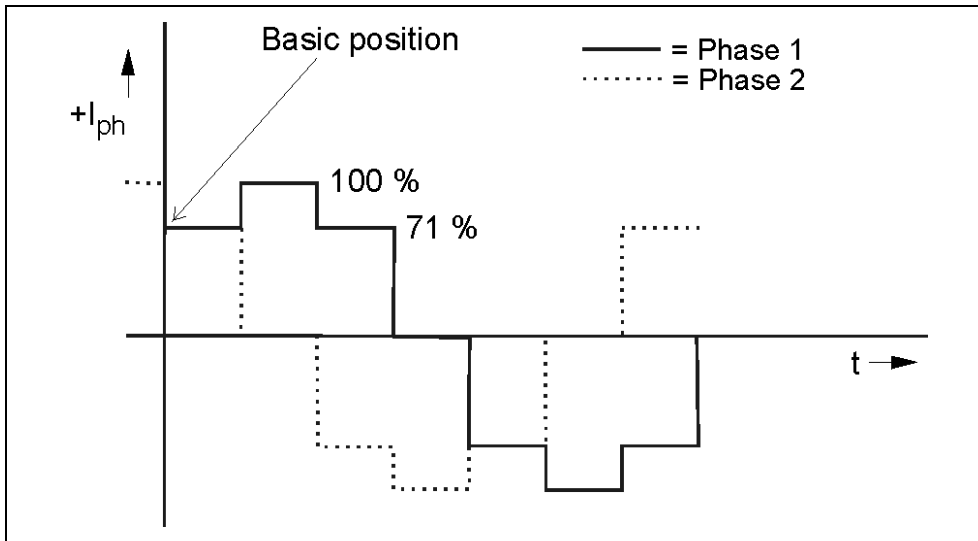

Fig. 39: Motor phases in basic position (half step)

If the motor is disabled no basic position signals are sent.

Every ...is generated	for the step resolution
4th control pulse	Full step
8th control pulse	Half step
16th control pulse	1/4 step
20th control pulse	1/5 step
40th control pulse	1/10 step

The basic position signal can be used in combination with an end of run limit switch to determine the system's datum.

1-STEP-DRIVE Module

9 ESD Protective Measures

Each product is tested before delivery and submitted to an endurance test run. To eliminate failures due to electrostatic discharge (ESD), a great many protective measures have been implemented throughout the entire manufacturing process - from incoming material to outgoing products.



When handling components, ESD protection measures (e. g. EN 61340-5) must be applied!

Our warranty does not cover failures due to incorrect handling.

10 Disclaimer

Phytron GmbH has verified the contents of the manual to match with the hardware and software. However, errors and omissions are exempt and Phytron GmbH assumes no responsibility for complete compliance. The information contained in this publication is reviewed regularly and any necessary corrections are included in subsequent editions.

11 Warranty and Trade Marks

The 1-STEP-DRIVE modules are subject to **legal warranty**. Phytron will repair or exchange devices which show a failure due to defects in material or caused by the production process. This warranty does not include damage caused by the customer, for example, not intended use, unauthorized modifications, incorrect handling or wiring.

SIMATIC[®], ET 200[®] and STEP[®]7 are trademarks of SIEMENS AG.

12 Appendix: Parameterization and Data Sets

12.1 Parameters in HW-Konfig (16-Byte-prm file)

	Bit 7	Bit 6	Bit 5	Bit 4	Bit 3	Bit 2	Bit 1	Bit 0
Byte 0	Universal parameter byte (format analog value, interference frequencies)							
Byte 1	Reserved = 0	Reserved = 0	Reserved = 0	Reserved = 0	Modulo axis: 0: not active 1: active	Module type: 0 (Reserved)		Group diagnostics 0: disable 1: enable
Byte 2	Reserved = 0	Reserved = 0	Format setting (for Byte 0 to 3 in the feedback interface) 0 0 : Residual distance 0 1 : Absolute position 1 0 : velocity (1 1 : Reserved)		Base Frequency F_b in Hz 0 : 800 1 : 400 2 : 200 3 : 80 4 : 40 5 : 20 6 : 8 7 : 4 8 : 2000			
Byte 3	Multiplier n: $F_{ss} = F_b * n$ (1..255)							
Byte 4	Time i: $a = F_b / (i * 0.128 \text{ ms})$ (1..255)							
Byte 5	Reserved = 0	Limit switch 0 : Normally closed contact 1 : Normally open contact	Input DI1 0 : Normally closed contact 1 : Normally open contact	Input DI0 0 : Normally closed contact 1 : Normally open contact	Function DI1 0 0 : Reference switch (0 1 : Reserved) 1 0 : Reference and limit switch forward 1 1 : Reference and limit switch backward		Function DI0 0 0 : External pulse enable 0 1 : External STOP 1 0 : Limit switch forward 1 1 : Limit switch backward	
Byte 6	Reserved = 0	Reserved = 0	Reserved = 0	Step resolution 0 : 1/1 1 : 1/2 2 : 1/2.5 3 : 1/4 4 : 1/5 5 : 1/8 6 : 1/10 7 : 1/16 8 : 1/20 9 : 1/32 10 : 1/64 11 : 1/128 12 : 1/256 13 : 1/512 14;15 not possible				Preferential direction 0: Normal direction 1: Opposite direction

1-STEP-DRIVE Module

	Bit 7	Bit 6	Bit 5	Bit 4	Bit 3	Bit 2	Bit 1	Bit 0
Byte 7	Reserved = 0	Reserved= 0	Reserved= 0	Run Current Delay Time 0 : 1 ms 1 : 2 ms 2 : 4 ms 3 : 6 ms 4 : 8 ms 5 : 10 ms 6 : 12 ms 7 : 14 ms 8 : 16 ms 9 : 20 ms 10 : 40 ms 11 : 60 ms 12 : 100 ms 13 : 200 ms 14 : 500 ms 15 : 1000 ms				ODIS behavior 0 : Power stage enable 1 : Power stage in stop current
Byte 8	Travel range: 1 ... 16777216							
Byte 9								
Byte 10								
Byte 11								
Byte 12	Run current 0 ... 3500 in 20 mA increments (300 mA)							
Byte 13	Stop current 0 ... 3500 in 20 mA increments (160 mA)							
Byte 14	Boost current 0 ... 3500 in 20 mA increments (400 mA)							
Byte 15	Reserved = 0	Reserved = 0	Reserved = 0	Switch rate Overdrive 0 : 1 kHz 1 : 2 kHz 2 : 4 kHz 3 : 8 kHz 4 : 10 kHz 5 : 15 kHz 6 : 20 kHz 7 : Overdrive off			Chopper frequency 0 : 18 kHz 1 : 20 kHz 2 : 22 kHz 3 : 25 kHz	

The presetting of the bits that are not listed in the prm file is "0".

12.2 Assignment of the Control Interface

Byte	Assignment	
0 to 3	Relative incremental mode, absolute incremental mode	
	Byte 0	Multiplier G: $F_a = F_b \times R \times G$ (value range 1 ... 255)
	Byte 1	Distance or position Bit 23 ... Bit 16
	Byte 2	Distance or position Bit 15 ... Bit 8
	Byte 3	Distance or position Bit 7 ... Bit 0
	or Reference point approach	
	Byte 0	Multiplier G: $F_a = F_b \times R \times G$ (value range 1 ... 255)
	Byte 1	Position Bit 23 ... Bit 16
	Byte 2	Position Bit 15 ... Bit 8
	Byte 3	Position Bit 7 ... Bit 0
	or Set home position	
	Byte 0	Reserved = 0
	Byte 1	Position Bit 23 ... Bit 16
	Byte 2	Position Bit 15 ... Bit 8
	Byte 3	Position Bit 7 ... Bit 0
	or Velocity control mode	
	Byte 0 to 3	Frequency as STEP [®] 7-Datatype REAL
	or Parameter Assignment Request	
	Byte 0	Reserved = 0
	Byte 1	Multiplier i: $a = F_b \times R / (i \times 0.128 \text{ ms})$ (value 1 ... 255)
	Byte 2	Multiplier n: $F_{ss} = F_b \times n \times R$ (value 1 ... 255)
	Byte 3	Base frequency F_b : <ul style="list-style-type: none"> • 0 = 800 Hz • 1 = 400 Hz • 2 = 200 Hz • 3 = 80 Hz • 4 = 40 Hz • 5 = 20 Hz • 6 = 8 Hz • 7 = 4 Hz • 8 = 2000 Hz

1-STEP-DRIVE Module

Byte/ Bit	Bit 7	Bit 6	Bit 5	Bit 4	Bit 3	Bit 0 bis 2	
Byte 4	Reduction factor 0: Factor 1.0 (no reduction) 1: Factor 0.1	Hold traversing job	Backward start	Forward start	Reserved = 0	Mode: 0: Relative incremental mode (relative positioning) 1: Reference point approach 2: Absolute incremental mode (absolute positioning) 3: Velocity control mode 4: Set home position	
	R	STOP	DIR_M	DIR_P	I	MODE	
Byte 5	Diagnostics error acknowledgment	Change parameter	Feedback value in the feedback interface 00: Residual distance 01: Position 10: Frequency 11: Reserved		Stop at the reference cam	Pulse enable	Limit switch in the
			Forward direction	Backward direction			
	EXTF_ACK	C_PAR	FEEDBACK	STOP_REF_EN	DRV_EN	LIMIT_P	LIMIT_M
Byte 6	Reserved =0						
Byte 7							

12.3 Assignment of the Feedback Interface

Byte/Bit	Assignment							
Byte 0 to 3	Bit 31...0							
	Residual distance (Bit 23 ... Bit 0 of 32 Bit) or Position (Bit 23 ... Bit 0 of 32 Bit) or Frequency (32 Bit, STEP [®] 7-Data type REAL)							
Byte/Bit	Bit 7	Bit 6	Bit 5	Bit 4	Bit 3	Bit 2	Bit 1	Bit 0
Byte 4	Power stage error	Reserved = 0	Parameter assignment error	Determining the home position	Reserved = 0	Position reached	Error during job transfer	Job transfer running
	ERR_DRV		ERR_PARA	SYNC		POS_RCD	ERR_JOB	STS_JOB
Byte 5	Traversing job running	Limit switch		External STOP	Reference cam	Status IN0	Status IN1	Status pulse enable active
		forward	backward					
		Is the cause for stop						
	POS	STOP_LIMIT_P	STOP_LIMIT_M	STOP_EXT	STOP_REF	STS_IN0	STS_IN1	STS_DRV_EN
Byte 6	Error number at an error during job transfer							
Byte 7	Reserved = 0							

1-STEP-DRIVE Module

12.4 Data Set 80

Byte/Bit	Bit 7	Bit 6	Bit 5	Bit 4	Bit 3	Bit 2	Bit 1	Bit 0	Type	
Byte 0	1	Deactivation	Basic position	Reset Error	0	0	0	0	Command bytes	
Byte 1	Reserved = 0									
Byte 2	Reserved = 0			Step resolution 0 : 1/1 1 : 1/2 2 : 1/2.5 3 : 1/4 4 : 1/5 5 : 1/8 6 : 1/10 7 : 1/16 8 : 1/20 9 : 1/32 10 : 1/64 11 : 1/128 12 : 1/256 13 : 1/512 14;15 not possible			Preferred direction of rotation 0: Normal direction 1: Reverse direction		Parameter bytes	
Byte 3	Reserved = 0			Current delay time 0 : 1 ms 1 : 2 ms 2 : 4 ms 3 : 6 ms 4 : 8 ms 5 : 10 ms 6 : 12 ms 7 : 14 ms 8 : 16 ms 9 : 20 ms 10 : 40 ms 11 : 60 ms 12 : 100 ms 13 : 200 ms 14 : 500 ms 15 : 1000 ms			ODIS behavior 0 : Power stage deactivated 1 : Power stage in stop current			
Byte 4	Run current 0 ... 3500 in 20 mA increments (300 mA)									
Byte 5	Stop current 0 ... 3500 in 20 mA increments (160 mA)									
Byte 6	Boost current 0 ... 3500 in 20 mA increments (400 mA)									
Byte 7	Reserved = 0			Switching frequency overdrive 0 : 1 kHz 1 : 2 kHz 2 : 4 kHz 3 : 8 kHz 4 : 10 kHz 5 : 15 kHz 6 : 20 kHz 7 : Overdrive off			Chopper frequency 0 : 18 kHz 1 : 20 kHz 2 : 22 kHz 3 : 25 kHz			

12.5 Data Set 81

Byte/Bit	Bit 7	Bit 6	Bit 5	Bit 4	Bit 3	Bit 2	Bit 1	Bit 0
Byte 0	Reserved							
Byte 1	Run	Boost	Basic position	Over temperature	Over current	0	Data set transfer	Parameter assignment error
Byte 2	Reserved			Step resolution			Preferred direction	
Byte 3	Reserved			Current delay time			ODIS behavior	
Byte 4	Run current							
Byte 5	Stop current							
Byte 6	Boost current							
Byte 7	Reserved			Switching frequency Overdrive			Chopper frequency	

1-STEP-DRIVE Module

13 Glossary

Term	Meaning
SIMATIC	SIMATIC is a product name of Siemens used for products in the automation, process control and manufacturing level. The SIMATIC automation products are electronic programmable logic controllers (PLC). The control functions are stored as firmware in a part of the CPU module. The SIMATIC is programmed by using the SIMATIC programming software STEP [®] 7. The automation components are modular and can be mounted next to the CPU with a variety of digital and analog I/O modules and pre-processing, intelligent modules.
S7 station	Superior PLC controller in the SIMATIC family
ET 200 [®] S station	Distributed, multi-modular and micro modular I/O system with different interface modules (also with CPU functionality) for connection to PROFIBUS or PROFINET. Power supplies, digital, analog and other technology modules, such as I/O-mastering and motor starters can be connected.
SIMATIC manager	The SIMATIC Manager looks after all data that belongs to an automation project. The tools required to process the selected data are started automatically by the SIMATIC Manager.
STEP [®] 7	Software for configuration and programming of SIMATIC Automation systems (part of the SIMATIC industrial software)
Hardware configuration	Configuration and parameterization of hardware for an automation project.
HW Config	Software tool for configuration of the hardware. It offers a slave-select dialog to insert the hardware modules according to the S7 project.
GSD file	The device database (GSD) describes the characteristics of a device type clearly and completely in an accurate and specific format. The GSD is produced by the equipment manufacturer for each type of device and is available to the user. The file describes a Profibus slave: address space size, number of inputs and outputs, length of contiguous blocks of data and configurable properties.

Term	Meaning
HSP file	Hardware support package defines the system environment of an ET 200 [®] S station and is used for the integration of modules (e.g. 1-STEP-DRIVE) in the SIMATIC CPU.
Statement list (STL)	Text-based, machine-level programming language. If a program is programmed in STL, the individual statements are similar to the steps with which the CPU executes the program. To facilitate the programming the STL was extended by some high level language constructs (such as structured data access and block parameters).
Function block (FB/FC)	Program parts (code blocks), made by-called <u>functions</u> (with or without saving status)
Data block (DB)	Data areas for storing user data. In addition to the data, which are each assigned to a function block, global data can be defined and used by any modules.
Organization block (OB)	A code block, which consists of a variable declaration part and a code section and characteristics (e.g. OB1).
DP-Master PROFIBUS-Master	CPU unit (master) in a distributed I/O system (DP)
Terminal module	The TM is a local interface for system wiring and connects to the power module PM-D to end.
Power module	The power module directs the voltages to the buses of the terminal modules that power the same group of devices. It monitors the power supply to the electronics and power supply "Schütz". Power failures are displayed and reported.
HW module (hardware module)	An electronic module e.g. 1-STEP-DRIVE, which is connected to a terminal module.
Base frequency F_b	Start/Stop frequency The start/stop frequency is the frequency at which the stepper motor can start or stop without a ramp and does not lose steps. The start/stop frequency is dependent on motor size and the load applied.
Feedback interface	8 byte data for controller's status: Content: Residual distance, absolute positioning, velocity

1-STEP-DRIVE Module

Term	Meaning
Control interface	8 byte data for position and direction information
Data set	<p>Parameters</p> <p>Various settings like frequency, acceleration ramps and waiting times are required to operate a controller. These are called parameters.</p> <p>Basic parameters are pre-set and with these the controller can be tailored for many applications.</p>
Feedback value	For flexibility, the current velocity, the current position or the distance yet to be traveled are available as a feedback value.
ODIS behavior	O utput d isable signal, enables the state of the PLC controller: Deactivated or in the stop current
External pulse enable	ENABLE input: Enables the system from an external signal.
External STOP	ENABLE input: Halts the axis from an external signal.
Residual distance	Recording of actual values (residual distance) normalized to units of length (steps).
Variable table (VAT)	The VATs are not loaded to the CPU and are created in the program for viewing and modifying variables.
RPM operating	In a programmable time window, all the pulses are counted, and thus the speed is determined.
Reduction factor	Velocity divisor
Reference cam	<p>Cams are digital signals connected to the controller's peripheral. The position-dependent switching to the master output signals can be delayed or run ahead. In order to compensate for switching times of connected actuators.</p> <p>Initiator Type: NCC or NOC</p>
Backplane bus	The backplane bus is a serial data bus over which the interface module IM151-1 communicates with the electronic modules / motor starters and provides them with the necessary voltage. The connection between the modules is via the terminal modules.
Isochronous	The synchronous coupling of a SIMATIC automation solution to the equidistant PROFIBUS is called isochronous.

Term	Meaning
PROFINET controller	Process Field Network (industry networking for data exchange in automation equipment with so-called master functionality)
Step resolution	Stepper motor power stages that use electronic measures to raise the physical resolution of the stepper motor are called micro step, mini step or fine step. For Phytron, this means the power stage can resolve to 1/512 of a full step. The selectable step resolution is, depending on the type of power stage, enhanced by a factor of 2 to 512. Converted into steps per revolution, a resolution of 1/512 for a 200 step motor results in: 102,400 ms per motor revolution or 0.0035° of the shaft.
Boost current	<p>Higher motor torque is required for acceleration and deceleration of a stepper motor compared to the torque at average and slew velocity (f_{max}). With a phase current setting adjusted for rapid acceleration and deceleration (steep ramps), the current is higher than needed while at constant velocity. The motor will heat up faster than with the rated current applied. With a lower phase current, it is only possible to accelerate or decelerate with correspondingly longer ramp times.</p> <p>Therefore, it is recommended to select different current settings for acceleration/deceleration and slewing:</p> <ul style="list-style-type: none"> – Continuous/slewing: Run current – Acceleration/deceleration: Boost current
Current delay time	The current delay time is an important feature of the stepper motor power stage technology. Power stages, also called amplifiers, are usually controlled by a pulse and a direction signal. The current delay time is the waiting time between the last arriving control pulse and change over from run current to a reduced stop current.

1-STEP-DRIVE Module

Term	Meaning
Overdrive	<p data-bbox="571 264 1417 376">With the Overdrive function, power stages enable motor independent compensation of the torque reduction when in the upper frequency range.</p> <p data-bbox="571 398 1444 510">The phase currents decrease with rising step frequency caused by the motor's regenerative action. The amplitude of the current curve becomes lower and the motor loses torque.</p> <p data-bbox="571 533 1423 768">The Overdrive function counteracts this by automatically raising the effective phase current by a factor of $\sqrt{2}$ from a defined limit frequency (generating a step curve). This counteracts the torque reduction. When the velocity decreases, the Overdrive function is automatically switched off with a certain hysteresis.</p> <p data-bbox="571 790 1337 869">The input control frequency for switching on or off the Overdrive function depends on the step resolution.</p>

14 Index

A

Absolute incremental mode 68
 Acceleration / Delay a 59
 Asynchronous 20
 Axis type 72

B

Base parameterizing 18
 Basic position 87
 Behavior at CPU-Master-STOP 77

C

Cable 17
 Changing Positioning Parameters during
 Operation 75
 Configuration transfer 7
 Control interface 7
 Copyright 2
 Current Delay Time 85

D

Data set transfer 18
 Digital input IN0 (3) 76
 Digital input IN1 (7) 76
 Dimensions 16

E

EMC 12
 Error detection 18

F

Feedback interface 7
 Frequency 63
 Full step 81

H

Half step 82
 Handling 11
 Hold traversing job 71

I

Inductivity 29
 Interfaces 19

L

LED 18
 Linear axis 72

M

Maximum Frequency / velocity of the Axis
 F_{max} 58
 Mini step 83
 Modulo axis 72
 Motor connection 29
 Motor time constant 29

N

Nominal voltage 17

O

Operating modes 18
 Operating temperature 12
 Overdrive 86

P

Parameter assignments 19
 Position 63
 Positioning 19
 Power stage 5
 Pulse Enable 74

R

Reference cam 71
 Reference point approach 73
 Relative positioning 67
 Residual distance 63
 Resonances 82, 83
 Ring counter 87

S

Sequence of Execution of the Search for
 Reference 64
 Set home position 66, 73
 Setting the acceleration / delay a 59
 Setting the starting frequency / velocity F_a
 57
 Shield contact element 21
 Starting frequency / velocity F_a 57
 Step resolution 17
 Stepper motor 17, 29
 Supply voltage 19
 Synchronous 19

T

Temperature 12
 Trade marks 88

1-STEP-DRIVE Module

Traversing job for reference point
approach 62

V

Velocity control mode 69

W

Warnings 10

Warranty 88

Weight 16

Wiring scheme 29

