



# **Ezi-SERVO<sup>®</sup> II** EtherCAT<sup>®</sup>

**Closed Loop Stepping System** **ALL**

- Motor + High Resolution Encoder + Drive + EtherCAT Interface
- Space Saving / Reduced Wiring
- CiA402 Drive Profile Support
- Closed-Loop Stepping System
- Tuning Not Required / No Hunting
- Low Heat Generation / High Torque

Ezi-SERVO II Series

Ezi-SERVO II  
EtherCAT

Ezi-SERVO II  
EtherCAT TO

Ezi-SERVO II  
EtherCAT MINI

Ezi-SERVO II  
EtherCAT 4X

Ezi-SERVO II  
EtherCAT ALL

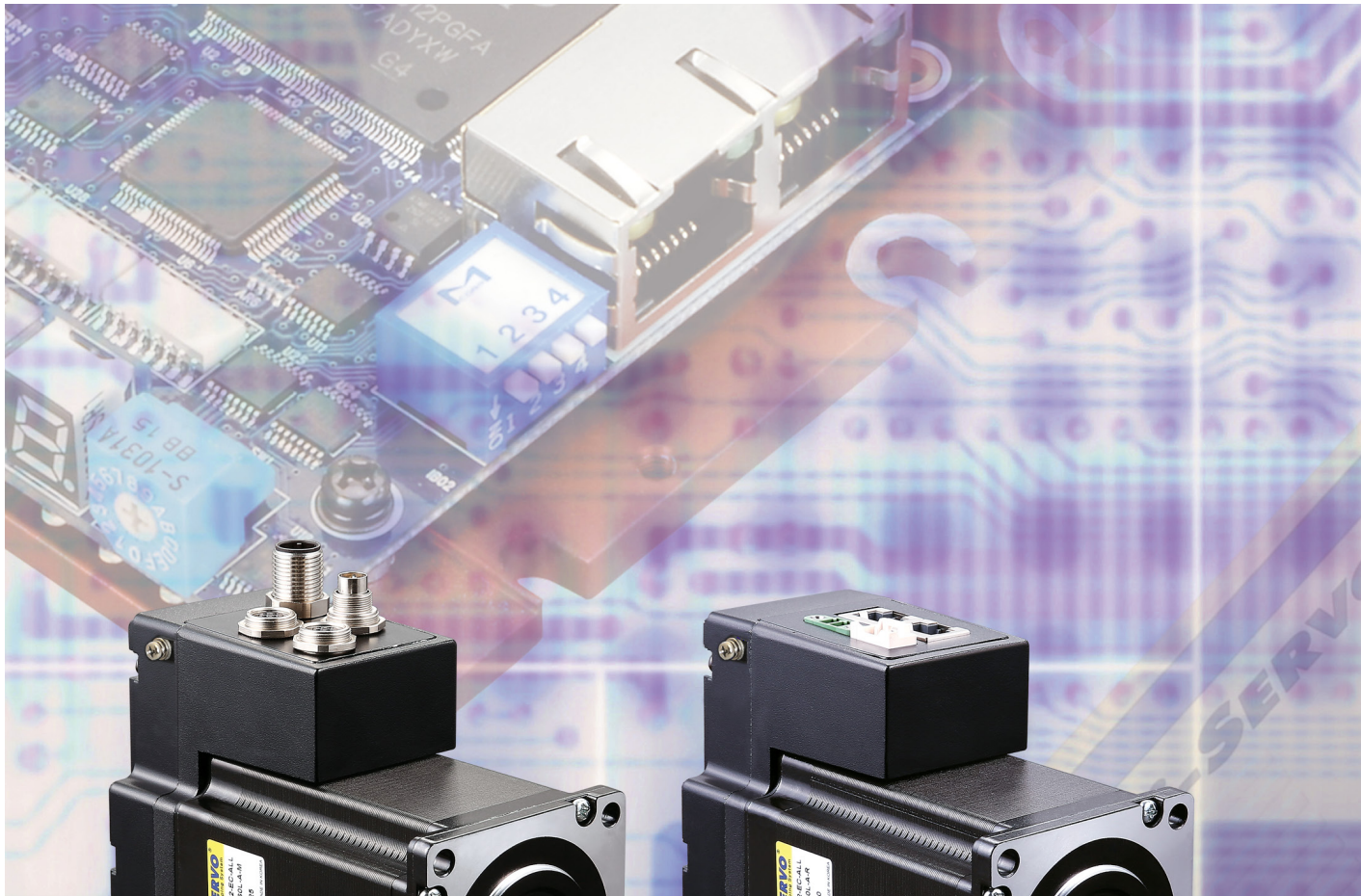

*Fast, Accurate, Smooth Motion*

**Ezi-SERVO<sup>®</sup> II**  
Closed Loop Stepping System

**EtherCAT<sup>®</sup>**  
**ALL**

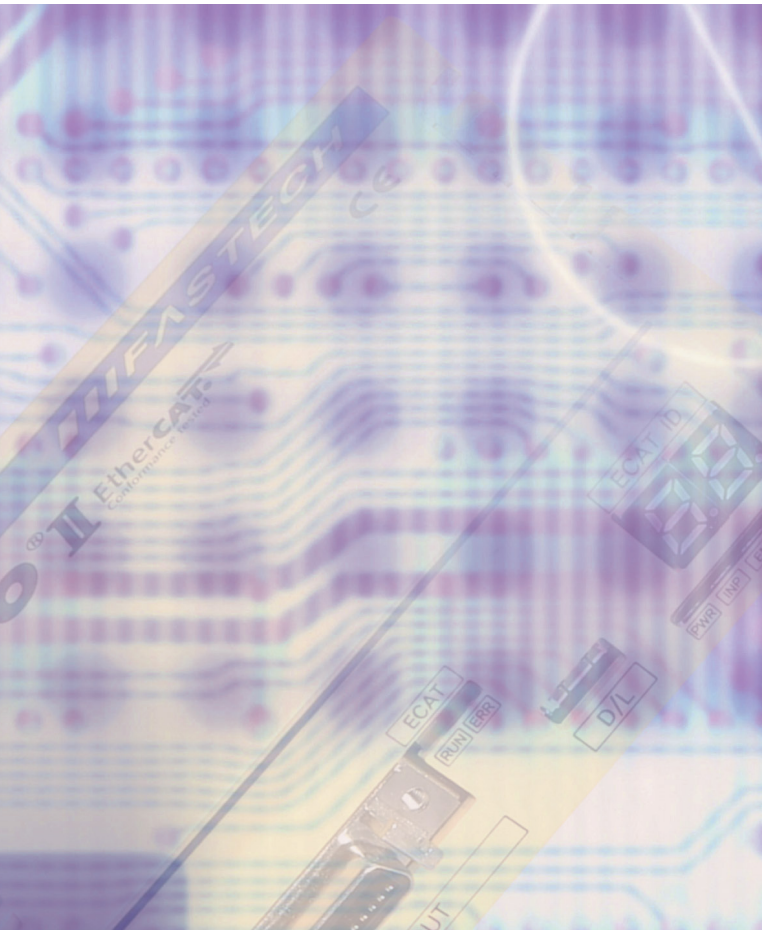

## 1 EtherCAT Based Motion Control

Ezi-SERVO II EtherCAT ALL is stepping motor control system using EtherCAT, high speed ethernet (100Mbps Full-Duplex) based fieldbus. Ezi-SERVO II EtherCAT ALL is EtherCAT slave module which supports CAN application layer over EtherCAT (CoE). It employs CiA 402 Drive Profile and supports Profile Position Mode, Homing Mode, Cyclic Synchronous Position Mode.



## 2 Closed-Loop System

Ezi-SERVO II is an innovative Closed-Loop System that utilizes a high-resolution motor mounted encoder constantly to monitor the current position. The encoder feedback allows the Ezi-SERVO II to update the current position every 50µs. It allows the Ezi-SERVO II drive to compensate for the loss of position, ensuring accurate positioning. For example, due to a sudden load change, a conventional stepping motor and drive could lose a step but Ezi-SERVO II automatically correct the position by encoder feedback.

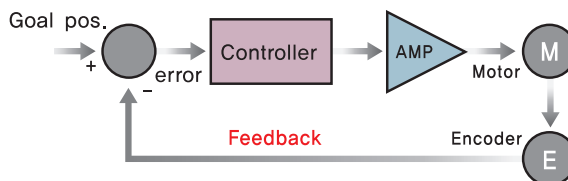

## 3 Tuning Not Required

To ensure machine performance, conventional servo systems require the adjustment of its servo's gains as an initial crucial step. Even systems that employ auto-tuning require manual tuning after the system is installed. Ezi-SERVO II employs the best characteristics of the stepping motor to eliminate the need of tedious gain tuning required for conventional closed-loop servo systems. Ezi-SERVO II is especially well suited for low-rigidity loads (e.g., a belt and pulley system) that sometimes require conventional servo systems to use the additional bulky and expensive gearbox.

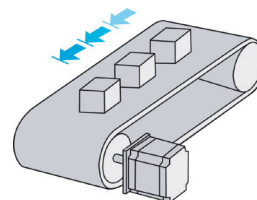

## 4 Low Heat Generation / Energy Savings

(Motor Current Control according to load)

Ezi-SERVO II automatically controls motor current according to load.

Ezi-SERVO II reduces motor current when motor load is low and increases motor current when load is high. By optimizing the motor current, motor heat can be minimized and energy can be saved.

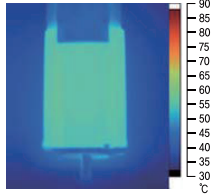

Motor temperature [Measured by Thermal Imaging Camera]

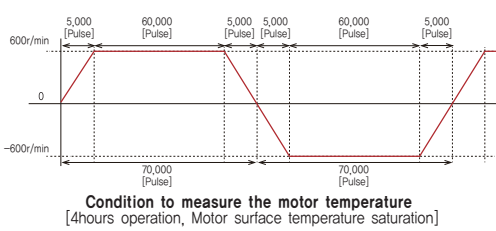

Condition to measure the motor temperature [4hours operation, Motor surface temperature saturation]

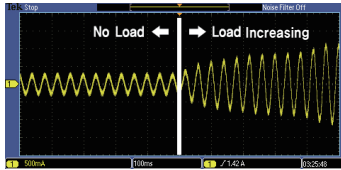

Example of the Motor Current Control according to load

## 5 High Torque

(Motor Current Setting)

Ezi-SERVO II can increase the motor current up to 150% by setting the Run Current by parameter. Therefore acceleration and deceleration characteristics and torque characteristics at low speed can be increased. Ezi-SERVO II can improve the torque in the low speed range by about 30%.

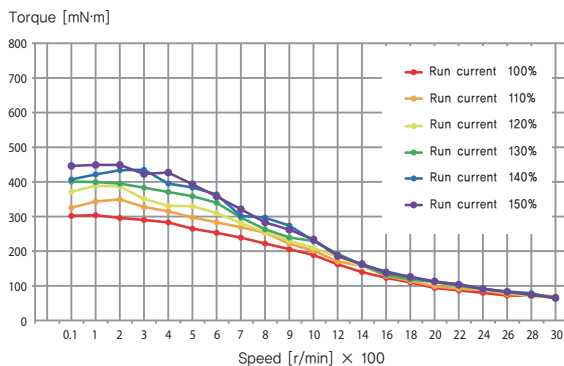

※ The torque at low speed is improved about 30%

Measured Condition : Drive = Ezi-SERVO II-EC-ALL-42L

## 6 No Hunting

Ezi-SERVO II utilizes the unique characteristics of stepping motors and locks itself into the desired target position, preventing vibration and eliminating Null Hunt which happens to the conventional servo systems.

This feature is especially useful in applications such as vision systems in which system oscillation and vibration could be a problem.

Complete Stop

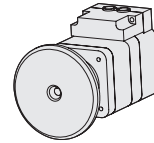

Hunting

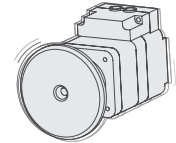

Ezi-SERVO II

Servo motor

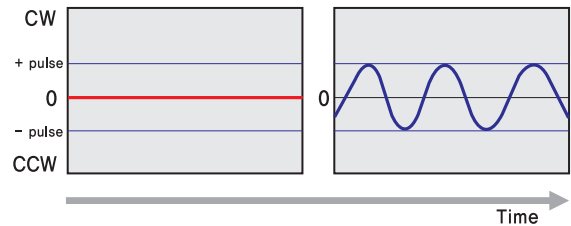

## 7 Smooth and Accurate Operation

Ezi-SERVO II is a high-precision servo drive, using a high-resolution encoder with 20,000 pulses/revolution. Unlike a conventional Microstep drive, the on-board high performance MCU (Micro Controller Unit) performs vector control and filtering, producing a smooth rotational control with minimum ripples.

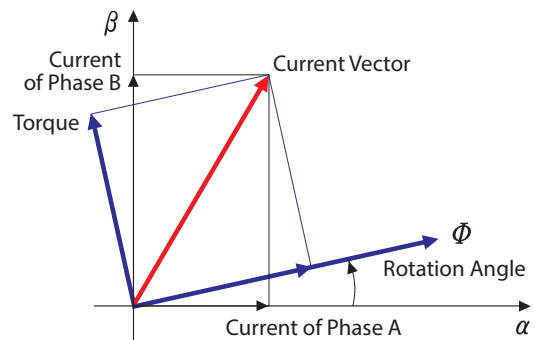

8

## High Response

Similar to conventional stepping motors, Ezi-SERVO II instantly synchronizes with command pulses providing fast positional response. Ezi-SERVO II is the optimal choice when zero-speed stability and rapid motions within a short distance are required. Traditional servo motor systems have a natural delay called settling time between the command input signals and the resultant motion because of the constant monitoring of the current position.

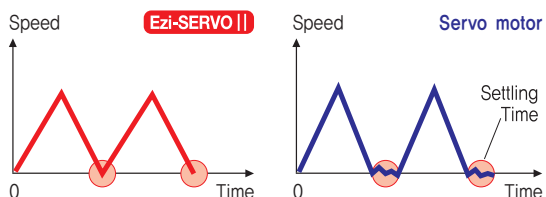

10

## High Torque / Continuous Operation

Compared with common stepping motors and drives, Ezi-SERVO II motion control systems can maintain a high torque state over relatively long period of time. This means that Ezi-SERVO II continuously operates without loss of position under 100% of the load. Unlike conventional Microstep drives, Ezi-SERVO II exploits continuous high torque operation during high speed motion due to its innovative optimum current phase control.

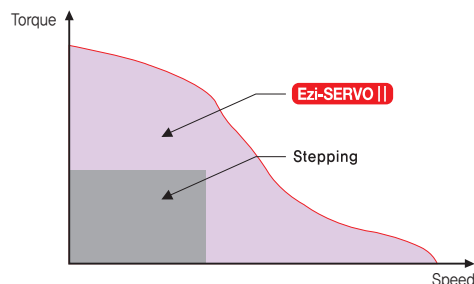

9

## High Resolution

The unit of the position command can be divided precisely. (Max. 20,000 pulses/revolution)

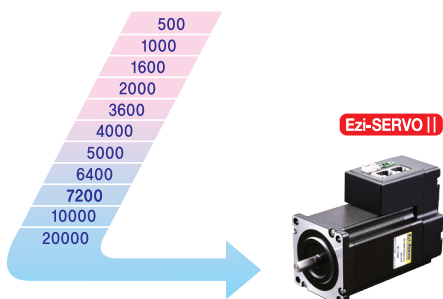

11

## High Speed

The Ezi-SERVO II operates well at high speed without the loss of synchronism or positioning error. Ezi-SERVO II's ability to monitor current position continuously enables the stepping motor to generate high torque, even under a 100% load condition.

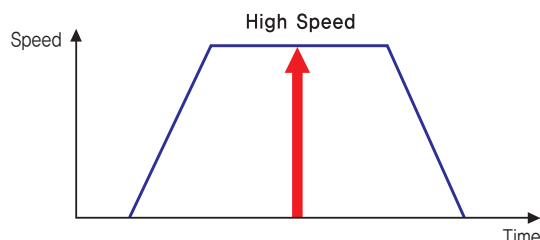

## Advantages over Open-Loop Stepping System Drive

1. Positioning is reliable without loss of synchronism.
2. It can hold stable position and automatically recover to the original position even after experiencing positioning error due to external forces, such as mechanical vibration or vertical positional holding.
3. Ezi-SERVO II utilizes 100% of rated motor torque, contrary to a conventional open-loop stepping driver that can use up to 50% of the rated motor torque due to the loss of synchronism.
4. Ezi-SERVO II can operate at high speed due to load-dependent current control, while open-loop stepping drives use a constant current control at all speed ranges without considering load variations. (Max Speed : 3,000r/min)

## Advantages over Servo Motor Controller

1. Tuning is not required. (Automatic gain adjustment in response to a load change)
2. It can maintain the stable holding position without oscillation after completion of positioning.
3. Positioning is fast due to the independent control by on-board MCU.
4. Operation is constant during rapid short-stroke movement due to instantaneous positioning.

● Ezi-SERVO II EtherCAT ALL Part Numbering

**Ezi-SERVO II-EC-ALL-56L-A-BK-PN5-M**

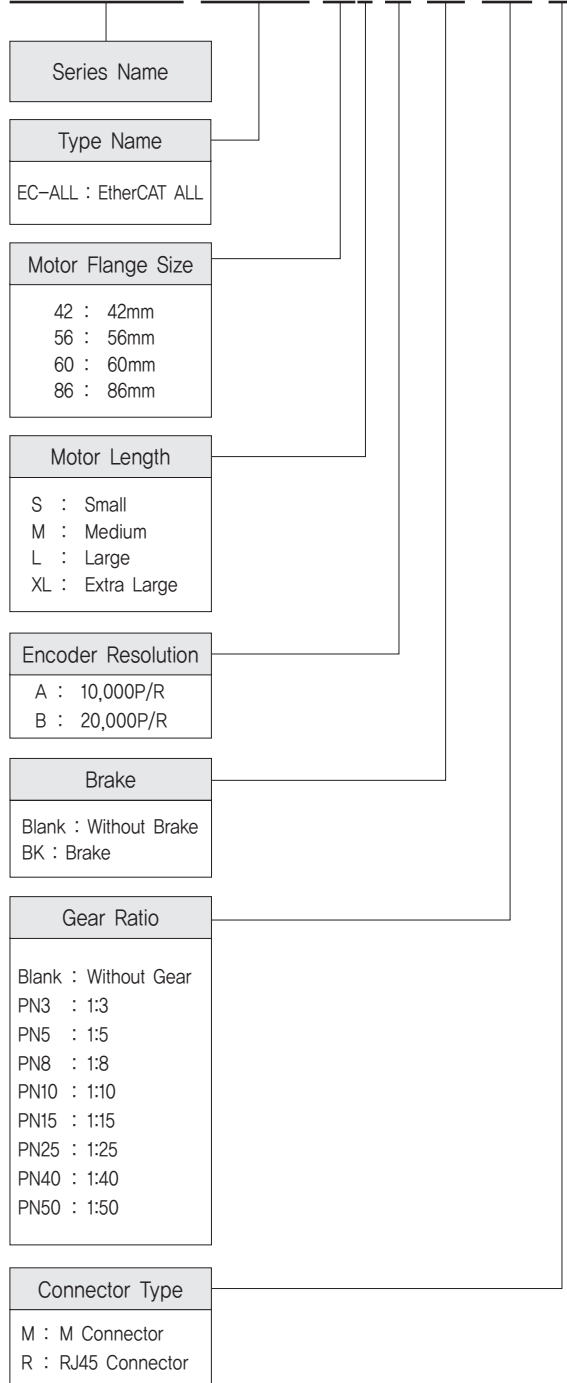

● Standard Combination

Unit Part Number	Motor Model Number	Drive Model Number
Ezi-SERVO II-EC-ALL-42M-A-M		
Ezi-SERVO II-EC-ALL-42M-B-M		
Ezi-SERVO II-EC-ALL-42M-A-R		
Ezi-SERVO II-EC-ALL-42M-B-R		
Ezi-SERVO II-EC-ALL-42L-A-M		
Ezi-SERVO II-EC-ALL-42L-B-M		
Ezi-SERVO II-EC-ALL-42L-A-R		
Ezi-SERVO II-EC-ALL-42L-B-R		
Ezi-SERVO II-EC-ALL-42XL-A-M		
Ezi-SERVO II-EC-ALL-42XL-B-M		
Ezi-SERVO II-EC-ALL-42XL-A-R		
Ezi-SERVO II-EC-ALL-42XL-B-R		
Ezi-SERVO II-EC-ALL-56S-A-M		
Ezi-SERVO II-EC-ALL-56S-B-M		
Ezi-SERVO II-EC-ALL-56S-A-R		
Ezi-SERVO II-EC-ALL-56S-B-R		
Ezi-SERVO II-EC-ALL-56M-A-M		
Ezi-SERVO II-EC-ALL-56M-B-M		
Ezi-SERVO II-EC-ALL-56M-A-R		
Ezi-SERVO II-EC-ALL-56M-B-R		
Ezi-SERVO II-EC-ALL-56L-A-M		
Ezi-SERVO II-EC-ALL-56L-B-M		
Ezi-SERVO II-EC-ALL-56L-A-R		
Ezi-SERVO II-EC-ALL-56L-B-R		
Ezi-SERVO II-EC-ALL-60S-A-M		
Ezi-SERVO II-EC-ALL-60S-B-M		
Ezi-SERVO II-EC-ALL-60S-A-R		
Ezi-SERVO II-EC-ALL-60S-B-R		
Ezi-SERVO II-EC-ALL-60M-A-M		
Ezi-SERVO II-EC-ALL-60M-B-M		
Ezi-SERVO II-EC-ALL-60M-A-R		
Ezi-SERVO II-EC-ALL-60M-B-R		
Ezi-SERVO II-EC-ALL-60L-A-M		
Ezi-SERVO II-EC-ALL-60L-B-M		
Ezi-SERVO II-EC-ALL-60L-A-R		
Ezi-SERVO II-EC-ALL-60L-B-R		
Ezi-SERVO II-EC-ALL-86M-A-M		
Ezi-SERVO II-EC-ALL-86M-B-M		
Ezi-SERVO II-EC-ALL-86M-A-R		
Ezi-SERVO II-EC-ALL-86M-B-R		
Ezi-SERVO II-EC-ALL-86L-A-M		
Ezi-SERVO II-EC-ALL-86L-B-M		
Ezi-SERVO II-EC-ALL-86L-A-R		
Ezi-SERVO II-EC-ALL-86L-B-R		
Ezi-SERVO II-EC-ALL-86XL-A-M		
Ezi-SERVO II-EC-ALL-86XL-B-M		
Ezi-SERVO II-EC-ALL-86XL-A-R		
Ezi-SERVO II-EC-ALL-86XL-B-R		

Motor & Drive Integrated

## ● Combination with Brake

Unit Part Number	Motor Model Number	Drive Model Number
Ezi-SERVO II-EC-ALL-42M-A-BK-M	Motor & Drive Integrated	
Ezi-SERVO II-EC-ALL-42M-B-BK-M		
Ezi-SERVO II-EC-ALL-42M-A-BK-R		
Ezi-SERVO II-EC-ALL-42M-B-BK-R		
Ezi-SERVO II-EC-ALL-42L-A-BK-M		
Ezi-SERVO II-EC-ALL-42L-B-BK-M		
Ezi-SERVO II-EC-ALL-42L-A-BK-R		
Ezi-SERVO II-EC-ALL-42L-B-BK-R		
Ezi-SERVO II-EC-ALL-42XL-A-BK-M		
Ezi-SERVO II-EC-ALL-42XL-B-BK-M		
Ezi-SERVO II-EC-ALL-42XL-A-BK-R		
Ezi-SERVO II-EC-ALL-42XL-B-BK-R		
Ezi-SERVO II-EC-ALL-56S-A-BK-M		
Ezi-SERVO II-EC-ALL-56S-B-BK-M		
Ezi-SERVO II-EC-ALL-56S-A-BK-R		
Ezi-SERVO II-EC-ALL-56S-B-BK-R		
Ezi-SERVO II-EC-ALL-56M-A-BK-M		
Ezi-SERVO II-EC-ALL-56M-B-BK-M		
Ezi-SERVO II-EC-ALL-56M-A-BK-R		
Ezi-SERVO II-EC-ALL-56M-B-BK-R		
Ezi-SERVO II-EC-ALL-56L-A-BK-M		
Ezi-SERVO II-EC-ALL-56L-B-BK-M		
Ezi-SERVO II-EC-ALL-56L-A-BK-R		
Ezi-SERVO II-EC-ALL-56L-B-BK-R		
Ezi-SERVO II-EC-ALL-60S-A-BK-M		
Ezi-SERVO II-EC-ALL-60S-B-BK-M		
Ezi-SERVO II-EC-ALL-60S-A-BK-R		
Ezi-SERVO II-EC-ALL-60S-B-BK-R		
Ezi-SERVO II-EC-ALL-60M-A-BK-M		
Ezi-SERVO II-EC-ALL-60M-B-BK-M		
Ezi-SERVO II-EC-ALL-60M-A-BK-R		
Ezi-SERVO II-EC-ALL-60M-B-BK-R		
Ezi-SERVO II-EC-ALL-60L-A-BK-M		
Ezi-SERVO II-EC-ALL-60L-B-BK-M		
Ezi-SERVO II-EC-ALL-60L-A-BK-R		
Ezi-SERVO II-EC-ALL-60L-B-BK-R		
Ezi-SERVO II-EC-ALL-86M-A-BK-M		
Ezi-SERVO II-EC-ALL-86M-B-BK-M		
Ezi-SERVO II-EC-ALL-86M-A-BK-R		
Ezi-SERVO II-EC-ALL-86M-B-BK-R		
Ezi-SERVO II-EC-ALL-86L-A-BK-M		
Ezi-SERVO II-EC-ALL-86L-B-BK-M		
Ezi-SERVO II-EC-ALL-86L-A-BK-R		
Ezi-SERVO II-EC-ALL-86L-B-BK-R		
Ezi-SERVO II-EC-ALL-86XL-A-BK-M		
Ezi-SERVO II-EC-ALL-86XL-B-BK-M		
Ezi-SERVO II-EC-ALL-86XL-A-BK-R		
Ezi-SERVO II-EC-ALL-86XL-B-BK-R		

## ● Combination with Gearbox

Unit Part Number	Motor Model Number	Drive Model Number	Gear Ratio	
Ezi-SERVO II-EC-ALL-42M-A-PN3-M	Motor & Drive Integrated		1:3	
Ezi-SERVO II-EC-ALL-42M-B-PN3-M				
Ezi-SERVO II-EC-ALL-42M-A-PN3-R				
Ezi-SERVO II-EC-ALL-42M-B-PN3-R				
Ezi-SERVO II-EC-ALL-42M-A-PN5-M		1:5		
Ezi-SERVO II-EC-ALL-42M-B-PN5-M				
Ezi-SERVO II-EC-ALL-42M-A-PN5-R				
Ezi-SERVO II-EC-ALL-42M-B-PN5-R				
Ezi-SERVO II-EC-ALL-42M-A-PN8-M		1:8		
Ezi-SERVO II-EC-ALL-42M-B-PN8-M				
Ezi-SERVO II-EC-ALL-42M-A-PN8-R				
Ezi-SERVO II-EC-ALL-42M-B-PN8-R				
Ezi-SERVO II-EC-ALL-42M-A-PN10-M		1:10		
Ezi-SERVO II-EC-ALL-42M-B-PN10-M				
Ezi-SERVO II-PE-ALL-42M-A-PN10-R				
Ezi-SERVO II-EC-ALL-42M-B-PN10-R				
Ezi-SERVO II-EC-ALL-42M-A-PN15-M		1:15		
Ezi-SERVO II-EC-ALL-42M-B-PN15-M				
Ezi-SERVO II-EC-ALL-42M-A-PN15-R				
Ezi-SERVO II-EC-ALL-42M-B-PN15-R				
Ezi-SERVO II-EC-ALL-42M-A-PN25-M		1:25		
Ezi-SERVO II-EC-ALL-42M-B-PN25-M				
Ezi-SERVO II-EC-ALL-42M-A-PN25-R				
Ezi-SERVO II-EC-ALL-42M-B-PN25-R				
Ezi-SERVO II-EC-ALL-42M-A-PN40-M		1:40		
Ezi-SERVO II-EC-ALL-42M-B-PN40-M				
Ezi-SERVO II-EC-ALL-42M-A-PN40-R				
Ezi-SERVO II-EC-ALL-42M-B-PN40-R				
Ezi-SERVO II-EC-ALL-42M-A-PN50-M		1:50		
Ezi-SERVO II-EC-ALL-42M-B-PN50-M				
Ezi-SERVO II-EC-ALL-42M-A-PN50-R				
Ezi-SERVO II-EC-ALL-42M-B-PN50-R				
Ezi-SERVO II-EC-ALL-42L-A-PN3-M		Motor & Drive Integrated		1:3
Ezi-SERVO II-EC-ALL-42L-B-PN3-M				
Ezi-SERVO II-EC-ALL-42L-A-PN3-R				
Ezi-SERVO II-EC-ALL-42L-B-PN3-R				
Ezi-SERVO II-EC-ALL-42L-A-PN5-M			1:5	
Ezi-SERVO II-EC-ALL-42L-B-PN5-M				
Ezi-SERVO II-EC-ALL-42L-A-PN5-R				
Ezi-SERVO II-EC-ALL-42L-B-PN5-R				
Ezi-SERVO II-EC-ALL-42L-A-PN8-M			1:8	
Ezi-SERVO II-EC-ALL-42L-B-PN8-M				
Ezi-SERVO II-EC-ALL-42L-A-PN8-R				
Ezi-SERVO II-EC-ALL-42L-B-PN8-R				
Ezi-SERVO II-EC-ALL-42L-A-PN10-M			1:10	
Ezi-SERVO II-EC-ALL-42L-B-PN10-M				
Ezi-SERVO II-EC-ALL-42L-A-PN10-R				
Ezi-SERVO II-EC-ALL-42L-B-PN10-R				
Ezi-SERVO II-EC-ALL-42L-A-PN15-M			1:15	
Ezi-SERVO II-EC-ALL-42L-B-PN15-M				
Ezi-SERVO II-EC-ALL-42L-A-PN15-R				
Ezi-SERVO II-EC-ALL-42L-B-PN15-R				
Ezi-SERVO II-EC-ALL-42L-A-PN25-M			1:25	
Ezi-SERVO II-EC-ALL-42L-B-PN25-M				
Ezi-SERVO II-EC-ALL-42L-A-PN25-R				
Ezi-SERVO II-EC-ALL-42L-B-PN25-R				
Ezi-SERVO II-EC-ALL-42L-A-PN40-M			1:40	
Ezi-SERVO II-EC-ALL-42L-B-PN40-M				
Ezi-SERVO II-EC-ALL-42L-A-PN40-R				
Ezi-SERVO II-EC-ALL-42L-B-PN40-R				
Ezi-SERVO II-EC-ALL-42L-A-PN50-M	1:50			
Ezi-SERVO II-EC-ALL-42L-B-PN50-M				
Ezi-SERVO II-EC-ALL-42L-A-PN50-R				
Ezi-SERVO II-EC-ALL-42L-B-PN50-R				



## ● Combination with Gearbox

Ezi-SERVO II Series

Ezi-SERVO II  
EtherCAT

Ezi-SERVO II  
EtherCAT TO

Ezi-SERVO II  
EtherCAT MINI

Ezi-SERVO II  
EtherCAT 4X

Ezi-SERVO II  
EtherCAT ALL

Unit Part Number	Motor Model Number	Drive Model Number	Gear Ratio
Ezi-SERVO II -EC-ALL-42XL-A-PN3-M	Motor & Drive Integrated		1:3
Ezi-SERVO II -EC-ALL-42XL-B-PN3-M			
Ezi-SERVO II -EC-ALL-42XL-A-PN3-R			
Ezi-SERVO II -EC-ALL-42XL-B-PN3-R			1:5
Ezi-SERVO II -EC-ALL-42XL-A-PN5-M			
Ezi-SERVO II -EC-ALL-42XL-B-PN5-M			
Ezi-SERVO II -EC-ALL-42XL-A-PN5-R			1:8
Ezi-SERVO II -EC-ALL-42XL-B-PN5-R			
Ezi-SERVO II -EC-ALL-42XL-A-PN8-M			
Ezi-SERVO II -EC-ALL-42XL-B-PN8-M			1:10
Ezi-SERVO II -EC-ALL-42XL-A-PN8-R			
Ezi-SERVO II -EC-ALL-42XL-B-PN8-R			
Ezi-SERVO II -EC-ALL-42XL-A-PN10-M			1:15
Ezi-SERVO II -EC-ALL-42XL-B-PN10-M			
Ezi-SERVO II -EC-ALL-42XL-A-PN10-R			
Ezi-SERVO II -EC-ALL-42XL-B-PN10-R			1:25
Ezi-SERVO II -EC-ALL-42XL-A-PN15-M			
Ezi-SERVO II -EC-ALL-42XL-B-PN15-M			
Ezi-SERVO II -EC-ALL-42XL-A-PN15-R			1:40
Ezi-SERVO II -EC-ALL-42XL-B-PN15-R			
Ezi-SERVO II -EC-ALL-42XL-A-PN25-M			
Ezi-SERVO II -EC-ALL-42XL-B-PN25-M			1:50
Ezi-SERVO II -EC-ALL-42XL-A-PN25-R			
Ezi-SERVO II -EC-ALL-42XL-B-PN25-R			
Ezi-SERVO II -EC-ALL-42XL-A-PN40-M			1:3
Ezi-SERVO II -EC-ALL-42XL-B-PN40-M			
Ezi-SERVO II -EC-ALL-42XL-A-PN40-R			
Ezi-SERVO II -EC-ALL-42XL-B-PN40-R			1:5
Ezi-SERVO II -EC-ALL-42XL-A-PN50-M			
Ezi-SERVO II -EC-ALL-42XL-B-PN50-M			
Ezi-SERVO II -EC-ALL-42XL-A-PN50-R			1:8
Ezi-SERVO II -EC-ALL-42XL-B-PN50-R			
Ezi-SERVO II -EC-ALL-56S-A-PN3-M			
Ezi-SERVO II -EC-ALL-56S-B-PN3-M			1:5
Ezi-SERVO II -EC-ALL-56S-A-PN3-R			
Ezi-SERVO II -EC-ALL-56S-B-PN3-R			
Ezi-SERVO II -EC-ALL-56S-A-PN5-M			1:8
Ezi-SERVO II -EC-ALL-56S-B-PN5-M			
Ezi-SERVO II -EC-ALL-56S-A-PN5-R			
Ezi-SERVO II -EC-ALL-56S-B-PN5-R			1:10
Ezi-SERVO II -EC-ALL-56S-A-PN8-M			
Ezi-SERVO II -EC-ALL-56S-B-PN8-M			
Ezi-SERVO II -EC-ALL-56S-A-PN8-R			1:15
Ezi-SERVO II -EC-ALL-56S-B-PN8-R			
Ezi-SERVO II -EC-ALL-56S-A-PN10-M			
Ezi-SERVO II -EC-ALL-56S-B-PN10-M			1:25
Ezi-SERVO II -EC-ALL-56S-A-PN10-R			
Ezi-SERVO II -EC-ALL-56S-B-PN10-R			
Ezi-SERVO II -EC-ALL-56S-A-PN15-M			1:40
Ezi-SERVO II -EC-ALL-56S-B-PN15-M			
Ezi-SERVO II -EC-ALL-56S-A-PN15-R			
Ezi-SERVO II -EC-ALL-56S-B-PN15-R	1:50		
Ezi-SERVO II -EC-ALL-56S-A-PN25-M			
Ezi-SERVO II -EC-ALL-56S-B-PN25-M			
Ezi-SERVO II -EC-ALL-56S-A-PN25-R	1:3		
Ezi-SERVO II -EC-ALL-56S-B-PN25-R			
Ezi-SERVO II -EC-ALL-56S-A-PN40-M			
Ezi-SERVO II -EC-ALL-56S-B-PN40-M	1:5		
Ezi-SERVO II -EC-ALL-56S-A-PN40-R			
Ezi-SERVO II -EC-ALL-56S-B-PN40-R			
Ezi-SERVO II -EC-ALL-56S-A-PN50-M	1:8		
Ezi-SERVO II -EC-ALL-56S-B-PN50-M			
Ezi-SERVO II -EC-ALL-56S-A-PN50-R			
Ezi-SERVO II -EC-ALL-56S-B-PN50-R	1:10		
Ezi-SERVO II -EC-ALL-56S-A-PN50-R			
Ezi-SERVO II -EC-ALL-56S-B-PN50-R			

Unit Part Number	Motor Model Number	Drive Model Number	Gear Ratio
Ezi-SERVO II -EC-ALL-56M-A-PN3-M	Motor & Drive Integrated		1:3
Ezi-SERVO II -EC-ALL-56M-B-PN3-M			
Ezi-SERVO II -EC-ALL-56M-A-PN3-R			
Ezi-SERVO II -EC-ALL-56M-B-PN3-R			1:5
Ezi-SERVO II -EC-ALL-56M-A-PN5-M			
Ezi-SERVO II -EC-ALL-56M-B-PN5-M			
Ezi-SERVO II -EC-ALL-56M-A-PN5-R			1:8
Ezi-SERVO II -EC-ALL-56M-B-PN5-R			
Ezi-SERVO II -EC-ALL-56M-A-PN8-M			
Ezi-SERVO II -EC-ALL-56M-B-PN8-M			1:10
Ezi-SERVO II -EC-ALL-56M-A-PN8-R			
Ezi-SERVO II -EC-ALL-56M-B-PN8-R			
Ezi-SERVO II -EC-ALL-56M-A-PN10-M			1:15
Ezi-SERVO II -EC-ALL-56M-B-PN10-M			
Ezi-SERVO II -EC-ALL-56M-A-PN10-R			
Ezi-SERVO II -EC-ALL-56M-B-PN10-R			1:25
Ezi-SERVO II -EC-ALL-56M-A-PN15-M			
Ezi-SERVO II -EC-ALL-56M-B-PN15-M			
Ezi-SERVO II -EC-ALL-56M-A-PN15-R			1:40
Ezi-SERVO II -EC-ALL-56M-B-PN15-R			
Ezi-SERVO II -EC-ALL-56M-A-PN25-M			
Ezi-SERVO II -EC-ALL-56M-B-PN25-M			1:50
Ezi-SERVO II -EC-ALL-56M-A-PN25-R			
Ezi-SERVO II -EC-ALL-56M-B-PN25-R			
Ezi-SERVO II -EC-ALL-56M-A-PN40-M			1:3
Ezi-SERVO II -EC-ALL-56M-B-PN40-M			
Ezi-SERVO II -EC-ALL-56M-A-PN40-R			
Ezi-SERVO II -EC-ALL-56M-B-PN40-R			1:5
Ezi-SERVO II -EC-ALL-56M-A-PN50-M			
Ezi-SERVO II -EC-ALL-56M-B-PN50-M			
Ezi-SERVO II -EC-ALL-56M-A-PN50-R			1:8
Ezi-SERVO II -EC-ALL-56M-B-PN50-R			
Ezi-SERVO II -EC-ALL-56L-A-PN3-M			
Ezi-SERVO II -EC-ALL-56L-B-PN3-M			1:5
Ezi-SERVO II -EC-ALL-56L-A-PN3-R			
Ezi-SERVO II -EC-ALL-56L-B-PN3-R			
Ezi-SERVO II -EC-ALL-56L-A-PN5-M			1:8
Ezi-SERVO II -EC-ALL-56L-B-PN5-M			
Ezi-SERVO II -EC-ALL-56L-A-PN5-R			
Ezi-SERVO II -EC-ALL-56L-B-PN5-R			1:10
Ezi-SERVO II -EC-ALL-56L-A-PN8-M			
Ezi-SERVO II -EC-ALL-56L-B-PN8-M			
Ezi-SERVO II -EC-ALL-56L-A-PN8-R			1:15
Ezi-SERVO II -EC-ALL-56L-B-PN8-R			
Ezi-SERVO II -EC-ALL-56L-A-PN10-M			
Ezi-SERVO II -EC-ALL-56L-B-PN10-M			1:25
Ezi-SERVO II -EC-ALL-56L-A-PN10-R			
Ezi-SERVO II -EC-ALL-56L-B-PN10-R			
Ezi-SERVO II -EC-ALL-56L-A-PN15-M			1:40
Ezi-SERVO II -EC-ALL-56L-B-PN15-M			
Ezi-SERVO II -EC-ALL-56L-A-PN15-R			
Ezi-SERVO II -EC-ALL-56L-B-PN15-R	1:50		
Ezi-SERVO II -EC-ALL-56L-A-PN25-M			
Ezi-SERVO II -EC-ALL-56L-B-PN25-M			
Ezi-SERVO II -EC-ALL-56L-A-PN25-R	1:3		
Ezi-SERVO II -EC-ALL-56L-B-PN25-R			
Ezi-SERVO II -EC-ALL-56L-A-PN40-M			
Ezi-SERVO II -EC-ALL-56L-B-PN40-M	1:5		
Ezi-SERVO II -EC-ALL-56L-A-PN40-R			
Ezi-SERVO II -EC-ALL-56L-B-PN40-R			
Ezi-SERVO II -EC-ALL-56L-A-PN50-M	1:8		
Ezi-SERVO II -EC-ALL-56L-B-PN50-M			
Ezi-SERVO II -EC-ALL-56L-A-PN50-R			
Ezi-SERVO II -EC-ALL-56L-B-PN50-R	1:10		
Ezi-SERVO II -EC-ALL-56L-A-PN50-R			
Ezi-SERVO II -EC-ALL-56L-B-PN50-R			

## ● Combination with Gearbox

Unit Part Number	Motor Model Number	Drive Model Number	Gear Ratio	Unit Part Number	Motor Model Number	Drive Model Number	Gear Ratio								
Ezi-SERVO II-EC-ALL-60S-A-PN3-M	Motor & Drive Integrated		1:3	Ezi-SERVO II-EC-ALL-60L-A-PN3-M	Motor & Drive Integrated		1:3								
Ezi-SERVO II-EC-ALL-60S-B-PN3-M				Ezi-SERVO II-EC-ALL-60L-B-PN3-M											
Ezi-SERVO II-EC-ALL-60S-A-PN3-R				Ezi-SERVO II-EC-ALL-60L-A-PN3-R											
Ezi-SERVO II-EC-ALL-60S-B-PN3-R				Ezi-SERVO II-EC-ALL-60L-B-PN3-R											
Ezi-SERVO II-EC-ALL-60S-A-PN5-M			1:5				1:5	Ezi-SERVO II-EC-ALL-60L-A-PN5-M	1:5		1:5				
Ezi-SERVO II-EC-ALL-60S-B-PN5-M								Ezi-SERVO II-EC-ALL-60L-B-PN5-M							
Ezi-SERVO II-EC-ALL-60S-A-PN5-R								Ezi-SERVO II-EC-ALL-60L-A-PN5-R							
Ezi-SERVO II-EC-ALL-60S-B-PN5-R								Ezi-SERVO II-EC-ALL-60L-B-PN5-R							
Ezi-SERVO II-EC-ALL-60S-A-PN8-M			1:8				1:8	Ezi-SERVO II-EC-ALL-60L-A-PN8-M	1:8		1:8				
Ezi-SERVO II-EC-ALL-60S-B-PN8-M								Ezi-SERVO II-EC-ALL-60L-B-PN8-M							
Ezi-SERVO II-EC-ALL-60S-A-PN8-R								Ezi-SERVO II-EC-ALL-60L-A-PN8-R							
Ezi-SERVO II-EC-ALL-60S-B-PN8-R								Ezi-SERVO II-EC-ALL-60L-B-PN8-R							
Ezi-SERVO II-EC-ALL-60S-A-PN10-M			1:10				1:10	Ezi-SERVO II-EC-ALL-60L-A-PN10-M	1:10		1:10				
Ezi-SERVO II-EC-ALL-60S-B-PN10-M								Ezi-SERVO II-EC-ALL-60L-B-PN10-M							
Ezi-SERVO II-EC-ALL-60S-A-PN10-R								Ezi-SERVO II-EC-ALL-60L-A-PN10-R							
Ezi-SERVO II-EC-ALL-60S-B-PN10-R								Ezi-SERVO II-EC-ALL-60L-B-PN10-R							
Ezi-SERVO II-EC-ALL-60S-A-PN15-M			1:15				1:15	Ezi-SERVO II-EC-ALL-60L-A-PN15-M	1:15		1:15				
Ezi-SERVO II-EC-ALL-60S-B-PN15-M								Ezi-SERVO II-EC-ALL-60L-B-PN15-M							
Ezi-SERVO II-EC-ALL-60S-A-PN15-R								Ezi-SERVO II-EC-ALL-60L-A-PN15-R							
Ezi-SERVO II-EC-ALL-60S-B-PN15-R								Ezi-SERVO II-EC-ALL-60L-B-PN15-R							
Ezi-SERVO II-EC-ALL-60S-A-PN25-M			1:25				1:25	Ezi-SERVO II-EC-ALL-60L-A-PN25-M	1:25		1:25				
Ezi-SERVO II-EC-ALL-60S-B-PN25-M								Ezi-SERVO II-EC-ALL-60L-B-PN25-M							
Ezi-SERVO II-EC-ALL-60S-A-PN25-R								Ezi-SERVO II-EC-ALL-60L-A-PN25-R							
Ezi-SERVO II-EC-ALL-60S-B-PN25-R								Ezi-SERVO II-EC-ALL-60L-B-PN25-R							
Ezi-SERVO II-EC-ALL-60S-A-PN40-M			1:40				1:40	Ezi-SERVO II-EC-ALL-60L-A-PN40-M	1:40		1:40				
Ezi-SERVO II-EC-ALL-60S-B-PN40-M								Ezi-SERVO II-EC-ALL-60L-B-PN40-M							
Ezi-SERVO II-EC-ALL-60S-A-PN40-R								Ezi-SERVO II-EC-ALL-60L-A-PN40-R							
Ezi-SERVO II-EC-ALL-60S-B-PN40-R								Ezi-SERVO II-EC-ALL-60L-B-PN40-R							
Ezi-SERVO II-EC-ALL-60S-A-PN50-M			1:50				1:50	Ezi-SERVO II-EC-ALL-60L-A-PN50-M	1:50		1:50				
Ezi-SERVO II-EC-ALL-60S-B-PN50-M								Ezi-SERVO II-EC-ALL-60L-B-PN50-M							
Ezi-SERVO II-EC-ALL-60S-A-PN50-R								Ezi-SERVO II-EC-ALL-60L-A-PN50-R							
Ezi-SERVO II-EC-ALL-60S-B-PN50-R								Ezi-SERVO II-EC-ALL-60L-B-PN50-R							
Ezi-SERVO II-EC-ALL-60M-A-PN3-M			Motor & Drive Integrated				1:3	Ezi-SERVO II-EC-ALL-86M-A-PN3-M	Motor & Drive Integrated		1:3				
Ezi-SERVO II-EC-ALL-60M-B-PN3-M								Ezi-SERVO II-EC-ALL-86M-B-PN3-M							
Ezi-SERVO II-EC-ALL-60M-A-PN3-R								Ezi-SERVO II-EC-ALL-86M-A-PN3-R							
Ezi-SERVO II-EC-ALL-60M-B-PN3-R								Ezi-SERVO II-EC-ALL-86M-B-PN3-R							
Ezi-SERVO II-EC-ALL-60M-A-PN5-M							1:5				1:5	Ezi-SERVO II-EC-ALL-86M-A-PN5-M	1:5		1:5
Ezi-SERVO II-EC-ALL-60M-B-PN5-M												Ezi-SERVO II-EC-ALL-86M-B-PN5-M			
Ezi-SERVO II-EC-ALL-60M-A-PN5-R												Ezi-SERVO II-EC-ALL-86M-A-PN5-R			
Ezi-SERVO II-EC-ALL-60M-B-PN5-R												Ezi-SERVO II-EC-ALL-86M-B-PN5-R			
Ezi-SERVO II-EC-ALL-60M-A-PN8-M	1:8				1:8	Ezi-SERVO II-EC-ALL-86M-A-PN8-M	1:8				1:8				
Ezi-SERVO II-EC-ALL-60M-B-PN8-M						Ezi-SERVO II-EC-ALL-86M-B-PN8-M									
Ezi-SERVO II-EC-ALL-60M-A-PN8-R						Ezi-SERVO II-EC-ALL-86M-A-PN8-R									
Ezi-SERVO II-EC-ALL-60M-B-PN8-R						Ezi-SERVO II-EC-ALL-86M-B-PN8-R									
Ezi-SERVO II-EC-ALL-60M-A-PN10-M	1:10				1:10	Ezi-SERVO II-EC-ALL-86M-A-PN10-M	1:10				1:10				
Ezi-SERVO II-EC-ALL-60M-B-PN10-M						Ezi-SERVO II-EC-ALL-86M-B-PN10-M									
Ezi-SERVO II-EC-ALL-60M-A-PN10-R						Ezi-SERVO II-EC-ALL-86M-A-PN10-R									
Ezi-SERVO II-EC-ALL-60M-B-PN10-R						Ezi-SERVO II-EC-ALL-86M-B-PN10-R									
Ezi-SERVO II-EC-ALL-60M-A-PN15-M	1:15				1:15	Ezi-SERVO II-EC-ALL-86M-A-PN15-M	1:15				1:15				
Ezi-SERVO II-EC-ALL-60M-B-PN15-M						Ezi-SERVO II-EC-ALL-86M-B-PN15-M									
Ezi-SERVO II-EC-ALL-60M-A-PN15-R						Ezi-SERVO II-EC-ALL-86M-A-PN15-R									
Ezi-SERVO II-EC-ALL-60M-B-PN15-R						Ezi-SERVO II-EC-ALL-86M-B-PN15-R									
Ezi-SERVO II-EC-ALL-60M-A-PN25-M	1:25				1:25	Ezi-SERVO II-EC-ALL-86M-A-PN25-M	1:25				1:25				
Ezi-SERVO II-EC-ALL-60M-B-PN25-M						Ezi-SERVO II-EC-ALL-86M-B-PN25-M									
Ezi-SERVO II-EC-ALL-60M-A-PN25-R						Ezi-SERVO II-EC-ALL-86M-A-PN25-R									
Ezi-SERVO II-EC-ALL-60M-B-PN25-R						Ezi-SERVO II-EC-ALL-86M-B-PN25-R									
Ezi-SERVO II-EC-ALL-60M-A-PN40-M	1:40				1:40	Ezi-SERVO II-EC-ALL-86M-A-PN40-M	1:40				1:40				
Ezi-SERVO II-EC-ALL-60M-B-PN40-M						Ezi-SERVO II-EC-ALL-86M-B-PN40-M									
Ezi-SERVO II-EC-ALL-60M-A-PN40-R						Ezi-SERVO II-EC-ALL-86M-A-PN40-R									
Ezi-SERVO II-EC-ALL-60M-B-PN40-R						Ezi-SERVO II-EC-ALL-86M-B-PN40-R									
Ezi-SERVO II-EC-ALL-60M-A-PN50-M	1:50				1:50	Ezi-SERVO II-EC-ALL-86M-A-PN50-M	1:50				1:50				
Ezi-SERVO II-EC-ALL-60M-B-PN50-M						Ezi-SERVO II-EC-ALL-86M-B-PN50-M									
Ezi-SERVO II-EC-ALL-60M-A-PN50-R						Ezi-SERVO II-EC-ALL-86M-A-PN50-R									
Ezi-SERVO II-EC-ALL-60M-B-PN50-R						Ezi-SERVO II-EC-ALL-86M-B-PN50-R									

## ● Combination with Gearbox

Unit Part Number	Motor Model Number	Drive Model Number	Gear Ratio	
Ezi-SERVO II -EC-ALL-86L-A-PN3-M	Motor & Drive Integrated		1:3	
Ezi-SERVO II -EC-ALL-86L-B-PN3-M				
Ezi-SERVO II -EC-ALL-86L-A-PN3-R				
Ezi-SERVO II -EC-ALL-86L-B-PN3-R				
Ezi-SERVO II -EC-ALL-86L-A-PN5-M				
Ezi-SERVO II -EC-ALL-86L-B-PN5-M				
Ezi-SERVO II -EC-ALL-86L-A-PN5-R			1:5	
Ezi-SERVO II -EC-ALL-86L-B-PN5-R				
Ezi-SERVO II -EC-ALL-86L-A-PN8-M				
Ezi-SERVO II -EC-ALL-86L-B-PN8-M				
Ezi-SERVO II -EC-ALL-86L-A-PN8-R				1:8
Ezi-SERVO II -EC-ALL-86L-B-PN8-R				
Ezi-SERVO II -EC-ALL-86L-A-PN10-M				
Ezi-SERVO II -EC-ALL-86L-B-PN10-M				
Ezi-SERVO II -EC-ALL-86L-A-PN10-R			1:10	
Ezi-SERVO II -EC-ALL-86L-B-PN10-R				
Ezi-SERVO II -EC-ALL-86L-A-PN15-M				
Ezi-SERVO II -EC-ALL-86L-B-PN15-M				
Ezi-SERVO II -EC-ALL-86L-A-PN15-R				1:15
Ezi-SERVO II -EC-ALL-86L-B-PN15-R				
Ezi-SERVO II -EC-ALL-86L-A-PN25-M				
Ezi-SERVO II -EC-ALL-86L-B-PN25-M				
Ezi-SERVO II -EC-ALL-86L-A-PN25-R			1:25	
Ezi-SERVO II -EC-ALL-86L-B-PN25-R				
Ezi-SERVO II -EC-ALL-86L-A-PN40-M				
Ezi-SERVO II -EC-ALL-86L-B-PN40-M				
Ezi-SERVO II -EC-ALL-86L-A-PN40-R				1:40
Ezi-SERVO II -EC-ALL-86L-B-PN40-R				
Ezi-SERVO II -EC-ALL-86L-A-PN50-M				
Ezi-SERVO II -EC-ALL-86L-B-PN50-M				
Ezi-SERVO II -EC-ALL-86L-A-PN50-R			1:50	
Ezi-SERVO II -EC-ALL-86L-B-PN50-R				
Ezi-SERVO II -EC-ALL-86XL-A-PN3-M				1:3
Ezi-SERVO II -EC-ALL-86XL-B-PN3-M				
Ezi-SERVO II -EC-ALL-86XL-A-PN3-R				
Ezi-SERVO II -EC-ALL-86XL-B-PN3-R				
Ezi-SERVO II -EC-ALL-86XL-A-PN5-M				
Ezi-SERVO II -EC-ALL-86XL-B-PN5-M				
Ezi-SERVO II -EC-ALL-86XL-A-PN5-R			1:5	
Ezi-SERVO II -EC-ALL-86XL-B-PN5-R				
Ezi-SERVO II -EC-ALL-86XL-A-PN8-M				
Ezi-SERVO II -EC-ALL-86XL-B-PN8-M				
Ezi-SERVO II -EC-ALL-86XL-A-PN8-R	1:8			
Ezi-SERVO II -EC-ALL-86XL-B-PN8-R				
Ezi-SERVO II -EC-ALL-86XL-A-PN10-M				
Ezi-SERVO II -EC-ALL-86XL-B-PN10-M				
Ezi-SERVO II -EC-ALL-86XL-A-PN10-R		1:10		
Ezi-SERVO II -EC-ALL-86XL-B-PN10-R				
Ezi-SERVO II -EC-ALL-86XL-A-PN15-M				
Ezi-SERVO II -EC-ALL-86XL-B-PN15-M				
Ezi-SERVO II -EC-ALL-86XL-A-PN15-R	1:15			
Ezi-SERVO II -EC-ALL-86XL-B-PN15-R				
Ezi-SERVO II -EC-ALL-86XL-A-PN25-M				
Ezi-SERVO II -EC-ALL-86XL-B-PN25-M				
Ezi-SERVO II -EC-ALL-86XL-A-PN25-R		1:25		
Ezi-SERVO II -EC-ALL-86XL-B-PN25-R				
Ezi-SERVO II -EC-ALL-86XL-A-PN40-M				
Ezi-SERVO II -EC-ALL-86XL-B-PN40-M				
Ezi-SERVO II -EC-ALL-86XL-A-PN40-R	1:40			
Ezi-SERVO II -EC-ALL-86XL-B-PN40-R				
Ezi-SERVO II -EC-ALL-86XL-A-PN50-M				
Ezi-SERVO II -EC-ALL-86XL-B-PN50-M				
Ezi-SERVO II -EC-ALL-86XL-A-PN50-R		1:50		
Ezi-SERVO II -EC-ALL-86XL-B-PN50-R				

Ezi-SERVO II Series

Ezi-SERVO II  
EtherCAT

Ezi-SERVO II  
EtherCAT TO

Ezi-SERVO II  
EtherCAT MINI

Ezi-SERVO II  
EtherCAT 4X

Ezi-SERVO II  
EtherCAT ALL

## Specifications of Drive

Model		Ezi-SERVO II-EC-ALL-42 series	Ezi-SERVO II-EC-ALL-56 series	Ezi-SERVO II-EC-ALL-60 series	Ezi-SERVO II-EC-ALL-86 series						
Input Voltage		DC24V±10%			DC48V±10%						
Control Method		Closed-loop control with 32bit MCU									
Current Consumption		Max. 500mA (Except motor current)									
Operating Condition	Ambient Temperature	<ul style="list-style-type: none"> <li>In Use: 0~50°C</li> <li>In Storage: -20~70°C</li> </ul>									
	Humidity	<ul style="list-style-type: none"> <li>In Use: 35~85%RH (Non-Condensing)</li> <li>In Storage: 10~90%RH (Non-Condensing)</li> </ul>									
	Vib. Resist.	0.5g									
Function	Rotation Speed	0~3,000r/min <sup>*1</sup>			0~2,000r/min <sup>*2</sup>						
	Resolution	Encoder Resolution [P/R]	Configurable Resolution [P/R]								
		10,000	500	1,000	1,600	2,000	3,600	5,000	6,400	7,200	10,000
		20,000	500	1,000	1,600	2,000	3,600	5,000	6,400	7,200	10,000
(Selectable by parameter)											
Error Types	Over Current Error, Over Speed Error, Position Tracking Error, Over Load Error, Over Temperature Error, Over Regenerated Voltage Error, Motor Connect Error, Encoder Connect Error, In-Position Error, ROM Error, Position Overflow Error										
EtherCAT	Supported Protocol	CoE (CiA 402 Drive Profile), FoE (Firmware Download)									
	Supported Mode	Profile Position Mode, Homing Mode, Cyclic Synchronous Position Mode									
	Synchronization	Free Run, SM Event, DC SYNC Event									
I/O Signal	Input Signals	3 dedicated inputs (LIMIT+, LIMIT-, ORIGIN), 3 programmable inputs (Photocoupler Input)									
	Output Signals	2 programmable outputs (Photocoupler Output), 1 Brake output									

<sup>\*1</sup> : Up to the resolution of 10,000P/R, maximum speed can be reached by 3,000r/min and with the resolution more than 10,000P/R, maximum speed shall be reduced accordingly.

<sup>\*2</sup> : Up to the resolution of 10,000P/R, maximum speed can be reached by 2,000r/min and with the resolution more than 10,000P/R, maximum speed shall be reduced accordingly.

## Specifications of Motor

MODEL		Ezi-SERVO II-EC-ALL-42 series			Ezi-SERVO II-EC-ALL-56 series				
		UNIT	42M	42L	42XL	56S	56M	56L	
DRIVE METHOD	-	Bipolar							
NUMBER OF PHASES	-	2 Phase							
CURRENT per PHASE	A/Phase	1,2	1,2	1,2	3,0	3,0	3,0		
MAXIMUM HOLDING TORQUE	N · m	0,44	0,5	0,65	0,64	1,0	1,5		
ROTOR INERTIA	g · cm <sup>2</sup>	54	77	114	180	280	520		
WEIGHTS	kg	0,440	0,520	0,660	0,760	0,920	1,360		
LENGTH(L)	mm	40	48	60	46	55	80		
PERMISSIBLE RADIAL LOAD	DISTANCE FROM END OF SHAFT	3mm	N	22	22	22	52	52	52
		8mm		26	26	26	65	65	65
		13mm		33	33	33	85	85	85
		18mm		46	46	46	123	123	123
PERMISSIBLE AXIAL LOAD	N	Lower than motor Unit's Weight							
INSULATION RESISTANCE	MΩ	Min. 100(When measured with a DC500V insulation resistance meter)							
INSULATION CLASS	-	CLASS B(130°C)							
OPERATING TEMPERATURE	°C	0 ~ 55							

MODEL		Ezi-SERVO II-EC-ALL-60 series			Ezi-SERVO II-EC-ALL-86 series				
		UNIT	60S	60M	60L	86M	86L	86XL	
DRIVE METHOD	-	Bipolar							
NUMBER OF PHASES	-	2 Phase							
CURRENT per PHASE	A/Phase	4,0	4,0	4,0	6,0	6,0	6,0		
MAXIMUM HOLDING TORQUE	N · m	0,88	1,28	2,4	4,5	8,5	12		
ROTOR INERTIA	g · cm <sup>2</sup>	240	490	690	1800	3600	5400		
WEIGHTS	kg	0,840	0,980	1,540	2,682	4,226	5,756		
LENGTH(L)	mm	47	56	85	78	117	155		
PERMISSIBLE RADIAL LOAD	DISTANCE FROM END OF SHAFT	3mm	N	70	70	70	270	270	270
		8mm		87	87	87	300	300	300
		13mm		114	114	114	350	350	350
		18mm		165	165	165	400	400	400
PERMISSIBLE AXIAL LOAD	N	Lower than motor Unit's Weight							
INSULATION RESISTANCE	MΩ	Min. 100(When measured with a DC500V insulation resistance meter)							
INSULATION CLASS	-	CLASS B(130°C)							
OPERATING TEMPERATURE	°C	0 ~ 55							

# Torque Characteristics of Motor

Ezi-SERVO II-EC-ALL-42 series

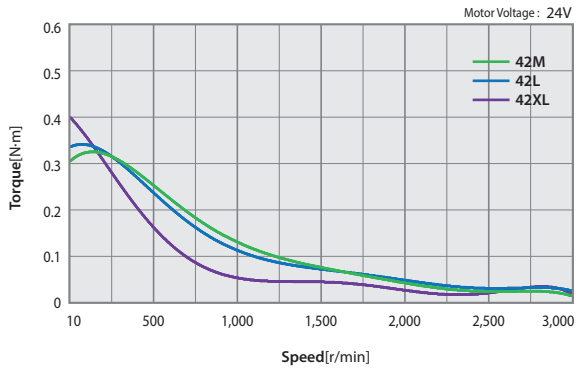

Ezi-SERVO II-EC-ALL-56 series

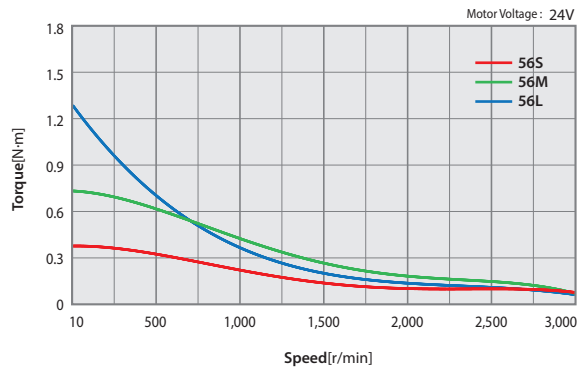

Ezi-SERVO II-EC-ALL-60 series

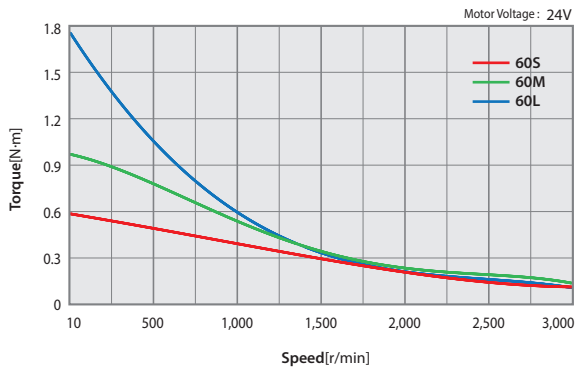

Ezi-SERVO II-EC-ALL-86 series

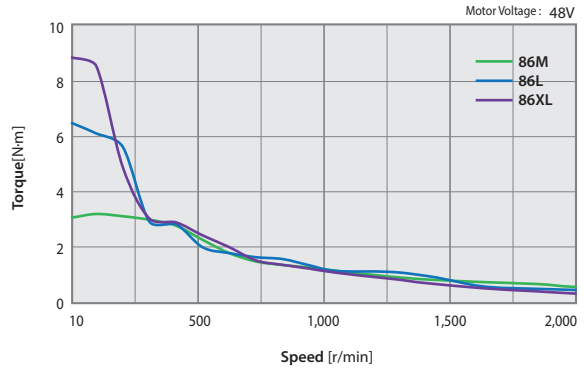

● Dimensions of Motor [mm]

◆ M Type

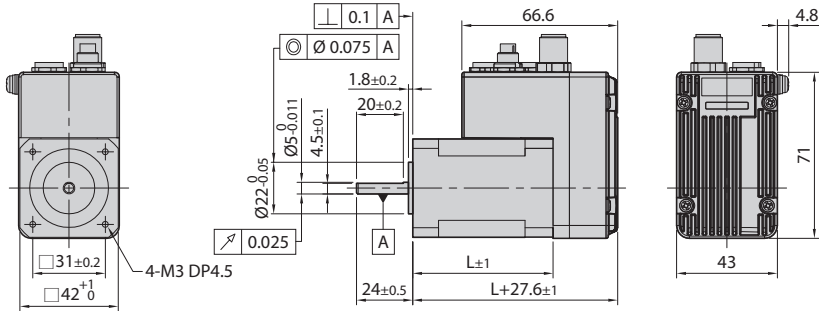

42mm

Model name	Length(L)
42M	40
42L	48
42XL	60

◆ R Type

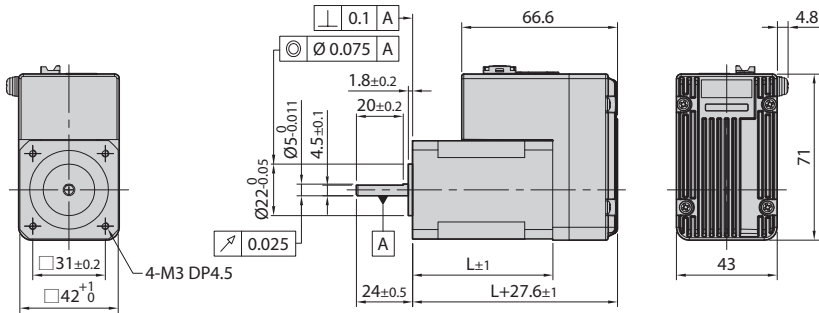

◆ M Type

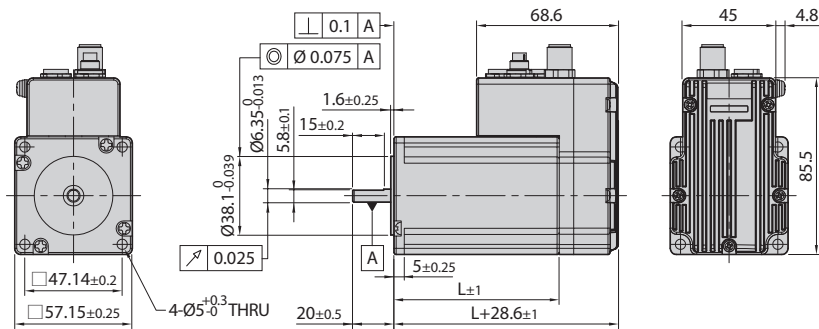

56mm

Model name	Length(L)
56S	46
56M	55
56L	80

◆ R Type

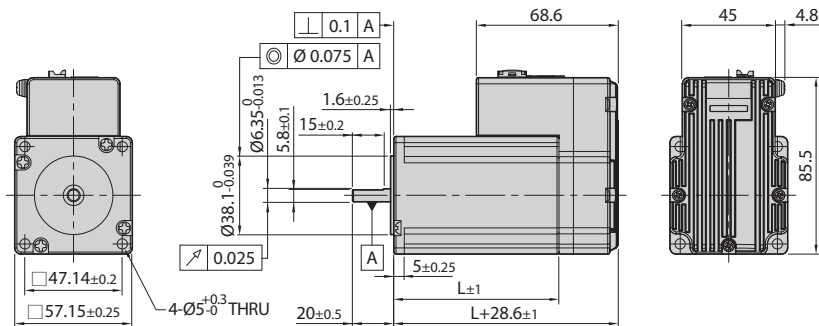

※ There are 2 kinds size of front shaft diameter for Ezi-SERVO II-EC-ALL-56 type as Ø6.35 and Ø8.0.

## ● Dimensions of Motor [mm]

### ◆ M Type

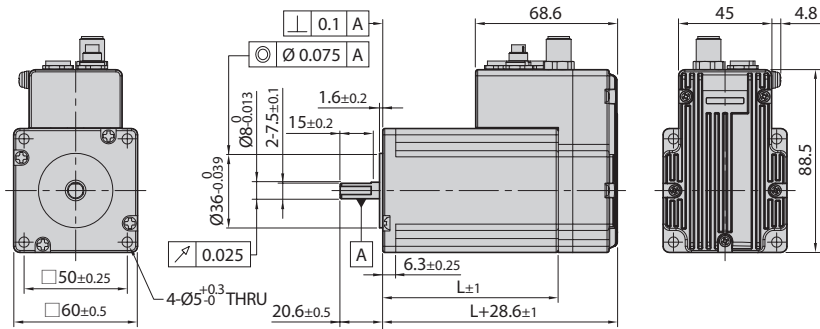

# 60mm

Model name	Length(L)
60S	47
60M	56
60L	85

### ◆ R Type

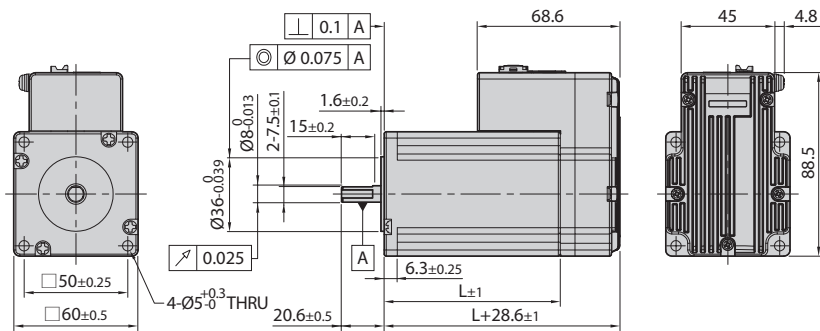

### ◆ M Type

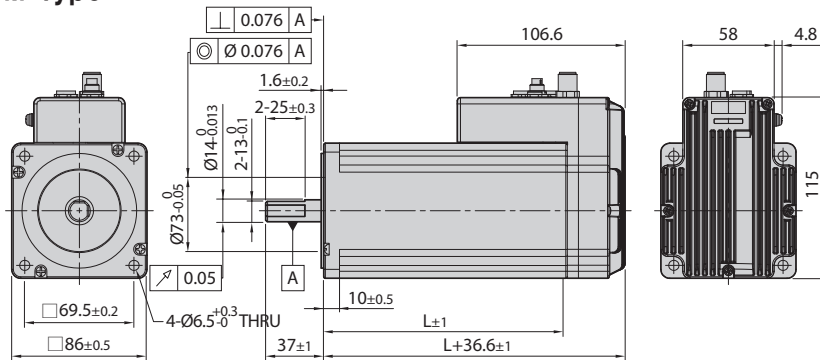

# 86mm

Model name	Length(L)
86M	78
86L	117
86XL	155

### ◆ R Type

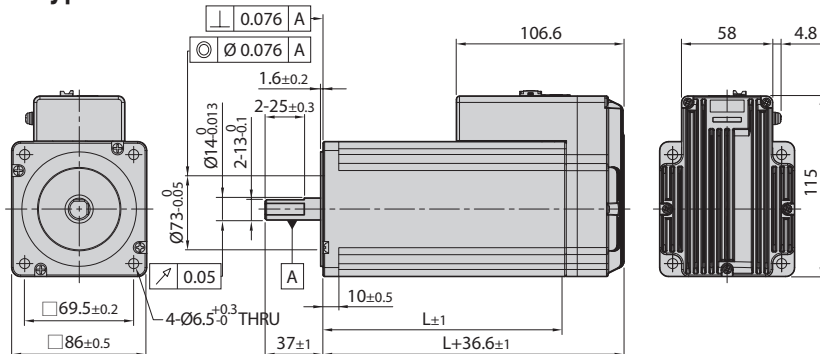



## ● Settings and Operation

### ◆ M Type

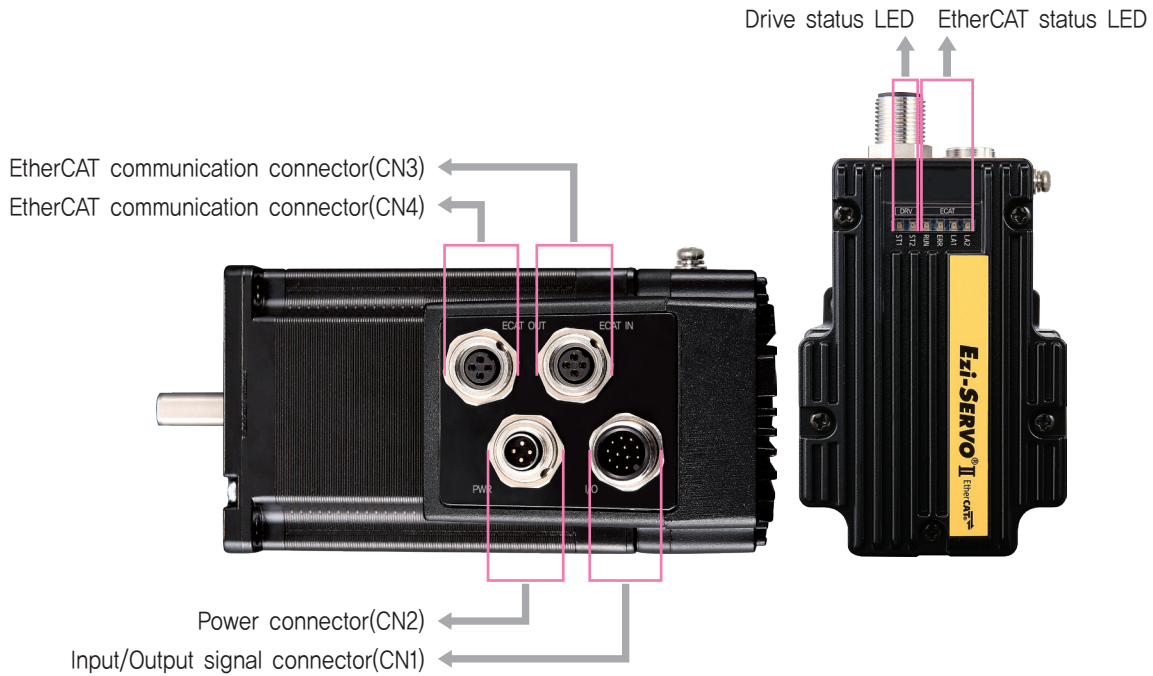

### ◆ R Type

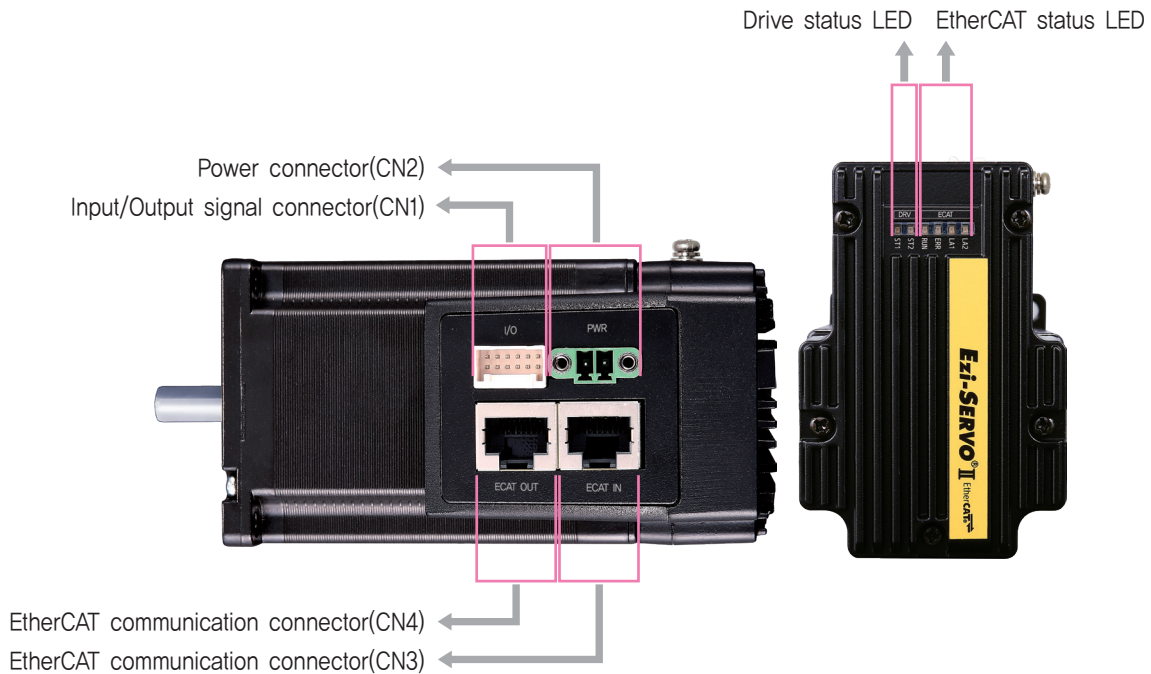

## 1. EtherCAT Status LED





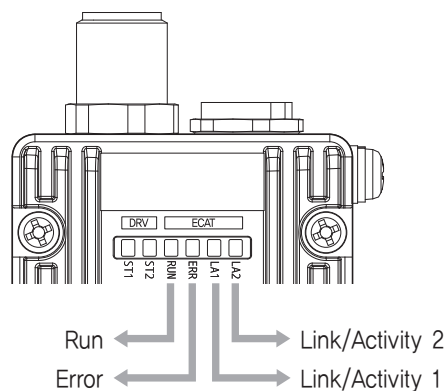



LED indicates communication status of EtherCAT.

Name	Color	Status	Description
RUN	Green	OFF	State INIT or Power OFF
		Blinking	State PRE-OPERATIONAL
		Single Flash	State SAFE-OPERATIONAL
		ON	State OPERATIONAL
		Flickering	State BOOTSTRAP
Name	Color	Status	Description
ERR	Red	OFF	No Error or Power OFF
		Blinking	Invalid Configuration
		Single Flash	Communication Data Error
		Double Flash	Watchdog Time Out
Name	Color	Status	Description
LA1/ LA2	Green	OFF	Link not Established
		ON	Link Established
		Flickering	Link Established and in Operation



## 2. Drive Status LED

LED informs operation status of the drive.

LED Indication	LED Status	Description
ST1 :  ST2 :	ST1 blinks, ST2 is OFF.	Servo On
ST1 :  ST2 :	ST1 is ON, ST2 is OFF.	Servo Off
ST1 :  ST2 : 	ST1 and ST2 are ON.	In motion
ST1 :  ST2 : 	ST1 and ST2 blink alternately.	A position error is greater than the set value (Inposition Value) while the motor is stopped.
ST1 :  ST2 : 	ST1 is OFF, ST2 blinks repeatedly for a set number of times depending on the type of error	Error

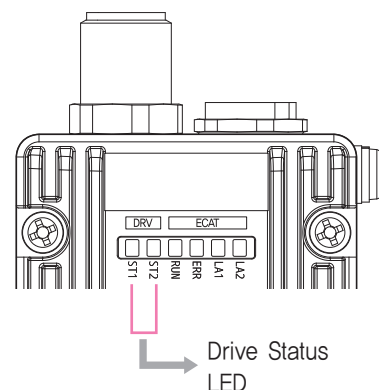

### ◆ List of error types by the number of ST2 LED blinking

No.	Error Type	Causes
1	Over Current Error	The current through power devices in drive exceeds the limit. <sup>*1</sup>
2	Over Speed Error	The motor speed exceeds 3,000r/min <sup>*2</sup>
3	Position Tracking Error	Position error value is greater than the reference value while the motor is running <sup>*3</sup>
4	Over Load Error	The motor is continuously operated more than 5 seconds under a load exceeding the max. torque.
5	Over Temperature Error	Internal temperature of the drive exceeds 85°C
6	Over Regenerative Voltage Error	Back-EMF is higher than limit value <sup>*4</sup>
7	Motor Connect Error	There is a problem with the connection between the drive and the motor
8	Encoder Connect Error	There is a problem with the connection between the drive and the encoder
10	In-Position Error	After operation is finished, position error larger than 1 pulse is continued for more than 3 seconds
12	ROM Error	Error occurs in parameter storage device(ROM)
14	Input Voltage Error	Input voltage exceeds the limit value <sup>*5</sup>
15	Position Overflow Error	Position error value is greater than the reference value while the motor is stopped <sup>*3</sup>

\*1 : Limit value depends on motor model. (Refer to the Manual)

\*2 : The speed limit of Ezi-SERVOII-EC-ALL 86 model is 2,000r/min.

\*3 : The default setting value is 180°, and it can be changed by parameter. (Refer to the Manual)

\*4 : Voltage limit of Back-EMF depends on motor model. (Refer to the Manual)

\*5 : Applied model : Ezi-SERVOII-EC-ALL-86, limit value = DC53V

※ Please refer to user Manual for the details of protection functions.

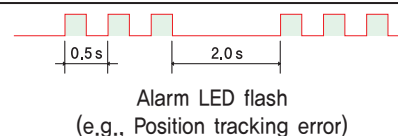

### 3. Input/Output Signal Connector(CN1)

No.	Function	I/O
1	EXT_DC24V	Input
2	EXT_GND	Input
3	BRAKE+	Output
4	BRAKE-	Output
5	LIMIT+	Input
6	LIMIT-	Input
7	ORIGIN	Input
8	Digital In1	Input
9	Digital In2	Input
10	Digital In3	Input
11	Digital Out1	Output
12	Digital Out2	Output

#### ◆ M Type

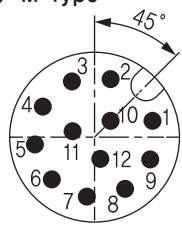

#### ◆ R Type

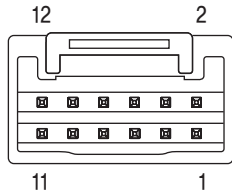

### 4. Power Connector(CN2)

#### ◆ M Type

No.	Function	I/O
1	DC24V	Input
2	DC24V	Input
3	GND	Input
4	GND	Input

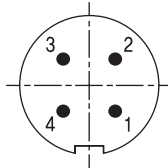

#### ◆ M Type(86mm)

No.	Function	I/O
1	DC48V	Input
2	DC48V	Input
3	GND	Input
4	GND	Input

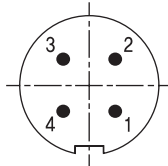

#### ◆ R Type

No.	Function	I/O
1	DC24V	Input
2	GND	Input

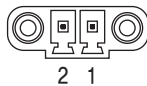

#### ◆ R Type(86mm)

No.	Function	I/O
1	DC48V	Input
2	GND	Input

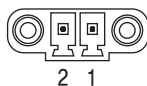

### 5. EtherCAT Communication Connector(CN3, CN4)

#### ◆ M Type

No.	Function
1	TD+
2	TD-
3	RD+
4	RD-
Connection hood	F_GND

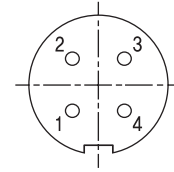

#### ◆ R Type

No.	Function	No.	Function
1	TD+	6	RD-
2	TD-	7	-----
3	RD+	8	-----
4	-----	Connection hood	F_GND
5	-----		

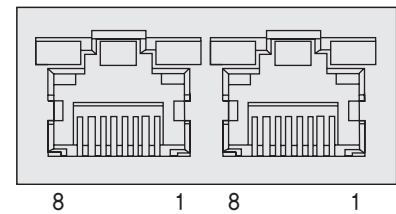

## ● System Configuration [M Type]

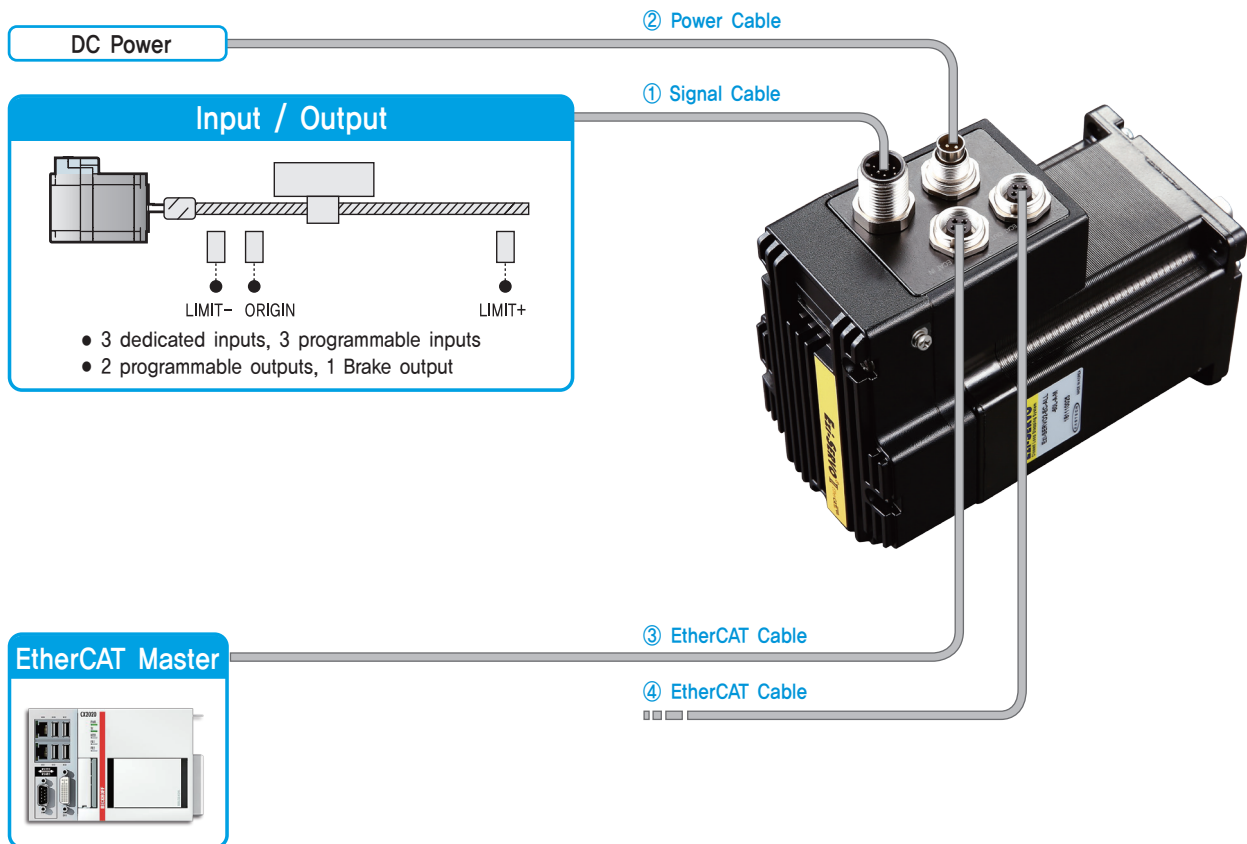

Cable Type	Max. Length	Remarks
① Signal Cable	20m	Options (Sold separately)
② Power Cable	2m	
③/④ EtherCAT Cable	100m	

### 1. Accessories

#### Connectors

These are connector specifications for drive cabling.

Purpose	Item	Part Number	Manufacturer
Signal (CN1)	Connector	99 0492 52 12	BINDER
Power (CN2)	Connector	99 0410 75 04	BINDER
EtherCAT (CN3, CN4)	Connector	99 0409 75 04	BINDER

※ The connectors above are supplied with the product. If you are using other parts, please make sure they meet the specifications.

## 2. Options

### ① Signal Cable

These are the cables to connect Ezi-SERVO II EtherCAT ALL [M Type] drive and other input/output devices.

Purpose	Part Number	Length [m]	Cable Type	Remarks
Drive – I/O Device Connection	CSNM-S-001F	1	Normal Cable	Maximum Length: 20m
	CSNM-S-002F	2		
	CSNM-S-003F	3		
	CSNM-S-005F	5		
	CSNM-S-001M	1	Robot Cable	
	CSNM-S-002M	2		
	CSNM-S-003M	3		
	CSNM-S-005M	5		

\* If you need cables with length(in units of 1m) not listed on the table, please contact FASTECH for more information.

### ② Signal Cable

These are the cables to connect Ezi-SERVO II EtherCAT ALL [M Type] drive and the power.

Purpose	Part Number	Length [m]	Cable Type	Remarks
Drive – Power Connection	CWPA-P-001F	1	Normal Cable	Maximum Length: 2m
	CWPA-P-002F	2		
	CWPA-P-001M	1	Robot Cable	
	CWPA-P-002M	2		

### ③ EtherCAT Cable (M Type Connector – RJ45)

These are the cables to connect Ezi-SERVO II EtherCAT ALL M Type and Ezi-SERVO II EtherCAT, Ezi-SERVO II EtherCAT ALL R Type with EtherCAT network,

Purpose	Part Number	Length [m]	Cable Type	Remarks
EtherCAT Connection	CGNM-EC-001F	1	Normal Cable	<ul style="list-style-type: none"> <li>· STP(Shielded Twisted Pair) Cable</li> <li>· Category 5e or higher</li> <li>· Maximum Length: 100m</li> </ul>
	CGNM-EC-002F	2		
	CGNM-EC-003F	3		
	CGNM-EC-005F	5		
	CGNM-EC-001M	1	Robot Cable	
	CGNM-EC-002M	2		
	CGNM-EC-003M	3		
	CGNM-EC-005M	5		

\* If you need cables with length(in units of 1m) not listed on the table, please contact FASTECH for more information.

### ④ EtherCAT Cable (M Type Connector – M Type Connector)

These are the cables to connect between Ezi-SERVO II EtherCAT ALL M Type products with EtherCAT network,

Purpose	Part Number	Length [m]	Cable Type	Remarks
EtherCAT Connection	CWMD-EC-001F	1	Normal Cable	<ul style="list-style-type: none"> <li>· STP(Shielded Twisted Pair) Cable</li> <li>· Category 5e or higher</li> <li>· Maximum Length: 100m</li> </ul>
	CWMD-EC-002F	2		
	CWMD-EC-003F	3		
	CWMD-EC-005F	5		
	CWMD-EC-001M	1	Robot Cable	
	CWMD-EC-002M	2		
	CWMD-EC-003M	3		
	CWMD-EC-005M	5		

\* If you need cables with length(in units of 1m) not listed on the table, please contact FASTECH for more information.

## ● System Configuration [R Type]

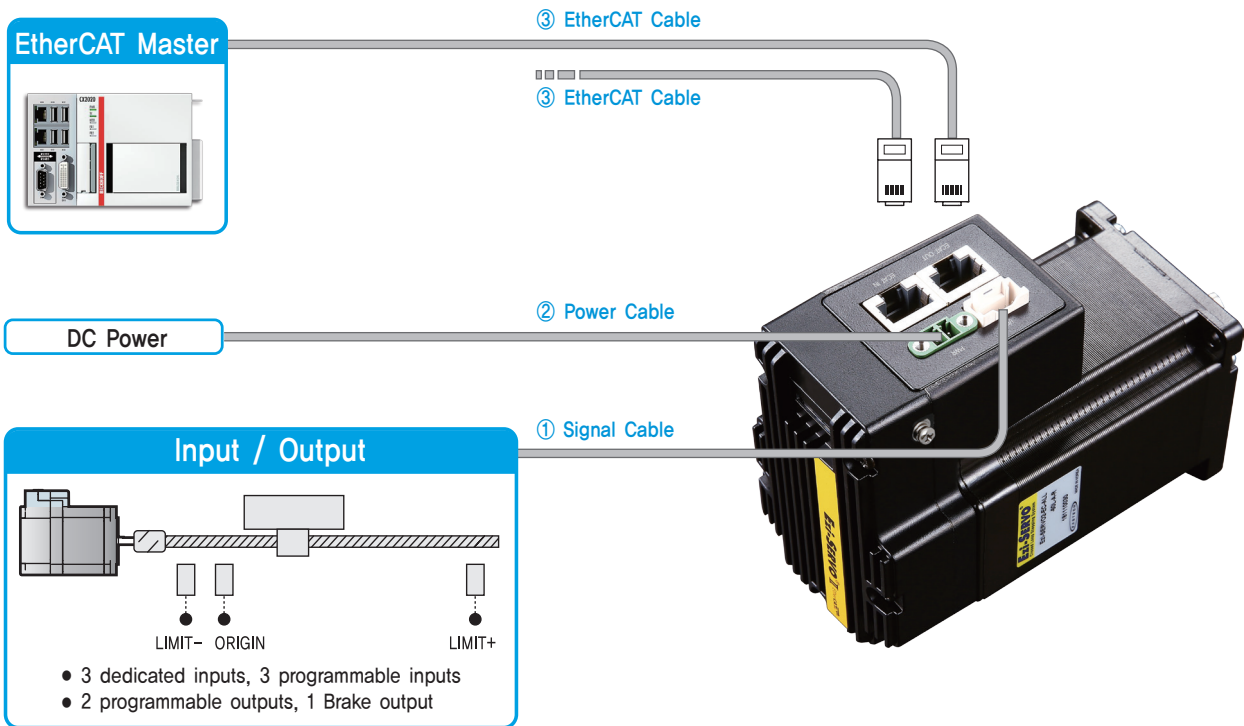

Cable Type	Max. Length	Remarks
① Signal Cable	20m	Options (Sold separately)
② Power Cable	2m	
③ EtherCAT Cable	100m	

### 1. Accessories

#### Connectors

These are connector specifications for drive cabling.

Purpose	Item	Part Number	Manufacturer
Signal (CN1)	Housing	501646-1200	MOLEX
	Terminal	501648-1000 (AWG 26~28)	
Power (CN2)	Terminal Block	MC421-38102	DECA

※ The connectors above are supplied with the product. If you are using other parts, please make sure they meet the specifications.

## 2. Options

### ① Signal Cable

These are the cables to connect Ezi-SERVO II EtherCAT ALL [R Type] drive and other input/output devices.

Purpose	Part Number	Length [m]	Cable Type	Remarks
Drive – I/O Device Connection	CSNR-S-001F	1	Normal Cable	Maximum Length: 20m
	CSNR-S-002F	2		
	CSNR-S-003F	3		
	CSNR-S-005F	5		
	CSNR-S-001M	1	Robot Cable	
	CSNR-S-002M	2		
	CSNR-S-003M	3		
	CSNR-S-005M	5		

\* If you need cables with length(in units of 1m) not listed on the table, please contact FASTECH for more information.

### ② Drive Power Cable

These are the cables to connect Ezi-SERVO II EtherCAT ALL [R Type] drive and the power.

Purpose	Part Number	Length [m]	Cable Type	Remarks
Drive – Power Connection	CSVA-P-001F	1	Normal Cable	Maximum Length: 2m
	CSVA-P-002F	2		
	CSVA-P-001M	1	Robot Cable	
	CSVA-P-002M	2		
R Type 86mm products Drive – Power Connection	CSPA-P-001F	1	Normal Cable	
	CSPA-P-002F	2		
	CSPA-P-001M	1	Robot Cable	
	CSPA-P-002M	2		

### ③ EtherCAT Cable

Purpose	Part Number	Length [m]	Cable Type	Remarks
EtherCAT Connection	CGNR-EC-001F	1	Normal Cable	<ul style="list-style-type: none"> <li>· STP(Shielded Twisted Pair) Cable</li> <li>· Category 5e or higher</li> <li>· Maximum Length: 100m</li> </ul>
	CGNR-EC-002F	2		
	CGNR-EC-003F	3		
	CGNR-EC-005F	5		
	CGNR-EC-001M	1	Robot Cable	
	CGNR-EC-002M	2		
	CGNR-EC-003M	3		
	CGNR-EC-005M	5		

\* If you need cables with length(in units of 1m) not listed on the table, please contact FASTECH for more information.

# External Wiring Diagram [M Type]

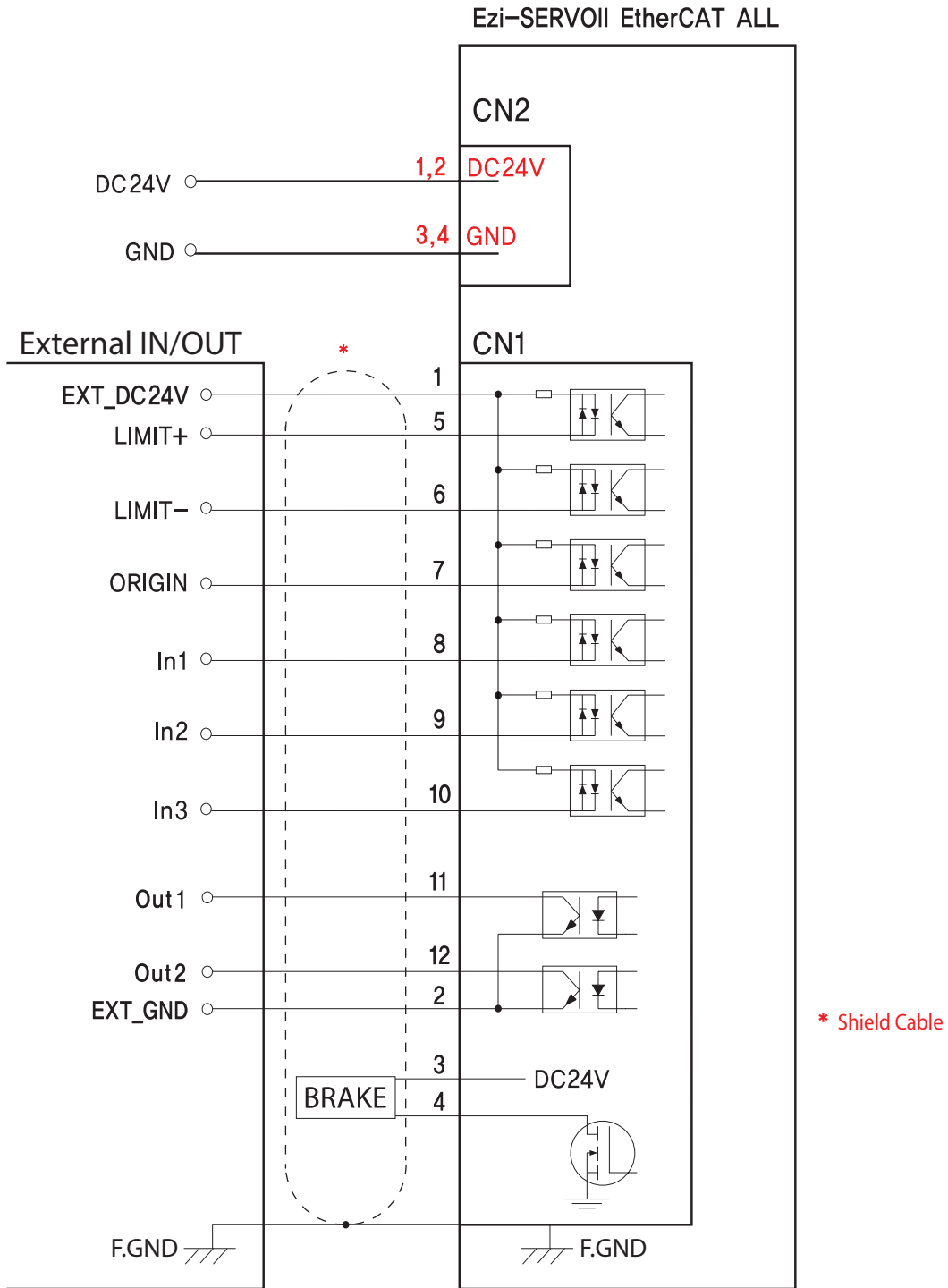

※ When connects I/O cable between controller and drive, please turn off the power of both controller and drive to prevent electric shock or to protect the drive from any damage.

**CAUTION**

In order to use the products listed in this catalog safely and correctly, be sure to read the instruction manual before using the product.