

TA12

series

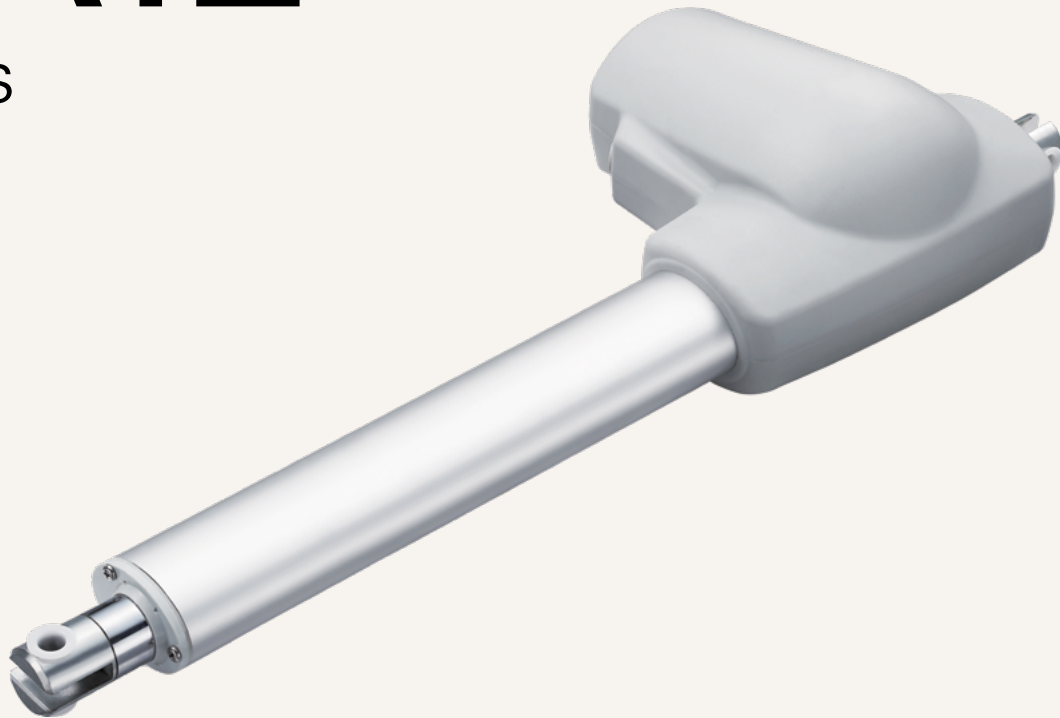

Product Segments

- **Care Motion**

TiMOTION's TA12 series linear actuator is designed primarily for high-load patient lifts and bariatric beds. These sensitive applications require a linear actuator whose design is focused on safety, reliability and effortless operation. A significant feature of the TA12 is the manual release function that allows for lowering of the patient in the event of an emergency or electrical power outage. The TA12 linear actuator has obtained the IEC60601-1 certification.

General Features

Max. load	12,000N (push); 6,000N (pull)
Max. speed at max. load	4mm/s
Max. speed at no load	57.3mm/s
Retracted length	≥ Stroke + 210mm
IP rating	IP66W
Certificate	IEC60601-1, ES60601-1, IEC60601-1-2, EMC
Stroke	25~1000mm
Output signals	Hall sensors, POT
Options	Safety nut, quick release, manual release
Voltage	12/24V DC (PTC); 24V DC, thermal protector (for patient hoist)
Color	Black, grey
Operational temperature range	+5°C~+45°C
Suitable for patient hoist application	

Drawing

Standard Dimensions
(mm)

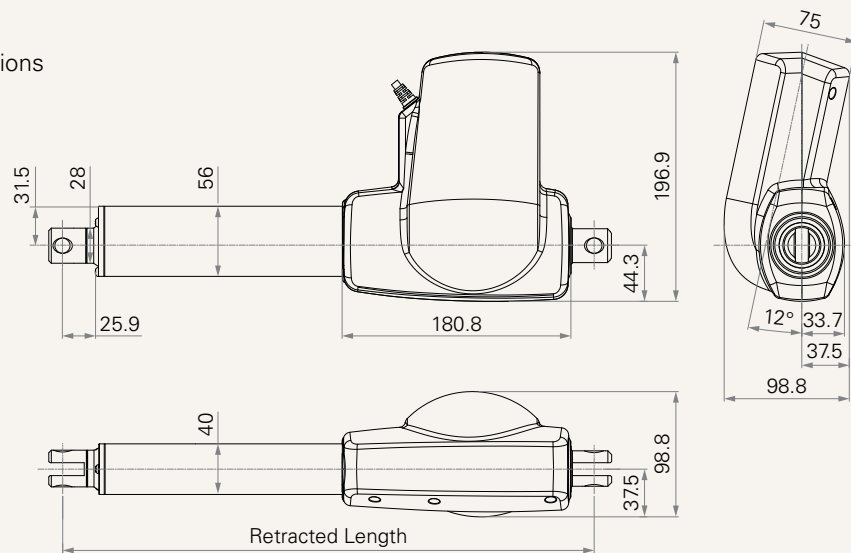

Load and Speed

CODE	Load (N)		Self Locking Force (N)	Typical Current (A)		Typical Speed (mm/s)	
	Push	Pull		No Load 32V DC	With Load 24V DC	No Load 32V DC	With Load 24V DC
Motor Speed (3800RPM, Duty Cycle 10%)							
B	12000	6000	12000	2.0	10.0	7.2	4.0
C	7000	6000	7000	2.5	9.0	14.4	8.1
D	4000	4000	4000	2.5	9.5	28.7	16.2
E	2500	2500	2500	2.5	8.5	43.1	24.3
F	1500	1500	1500	2.5	7.5	57.3	32.3
Motor Speed (3000RPM, Duty Cycle 10%)							
G	10000	6000	10000	2.0	10.0	11.0	5.2
H	12000	6000	12000	2.0	7.5	5.5	3.1
J	7000	6000	7000	2.0	7.5	11.3	6.0
K	4000	4000	4000	2.0	7.0	22.7	12.7
L	2500	2500	2500	2.0	6.5	34.0	19.1
M	1500	1500	1500	2.0	6.0	45.3	25.5

Note

- 1 Please refer to the approved drawing for the final authentic value.
- 2 This self-locking force level is reached only when a short circuit is applied on the terminals of the motor. All the TiMOTION control boxes have this feature built-in.
- 3 Operational temperature range at full performance: +5°C~+45°C
- 4 The current & speed in table are tested when the actuator is extending under push load.
- 5 The current & speed in table and diagram are tested with TiMOTION control boxes, and there will be around 10% tolerance depending on different models of the control box. (Under no load condition, the voltage is around 32V DC. At rated load, the voltage output will be around 24V DC)
- 6 Standard stroke: Min. ≥ 25mm, Max. please refer to below table.

CODE	Load (N)	Max Stroke (mm)
B, G, H	≥ 8000	450
D, E, F, K, L, M	< 6000	1000

Performance Data (24V DC Motor)

Motor Speed (3800RPM, Duty Cycle 10%)

Speed vs. Load

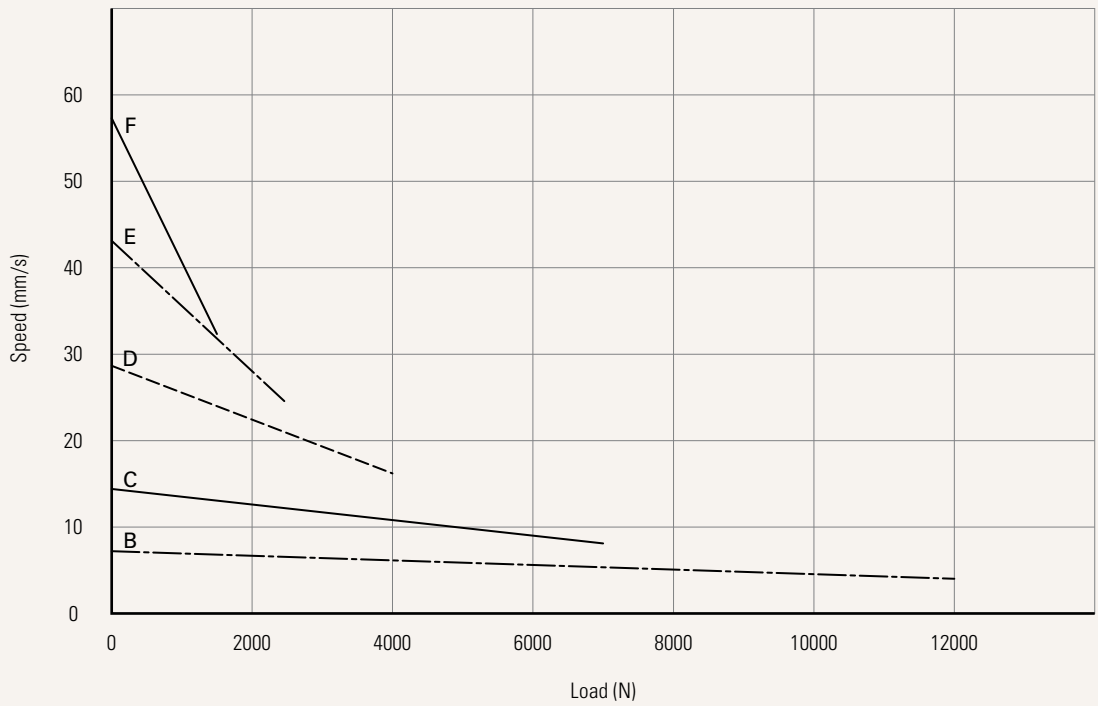

Current vs. Load

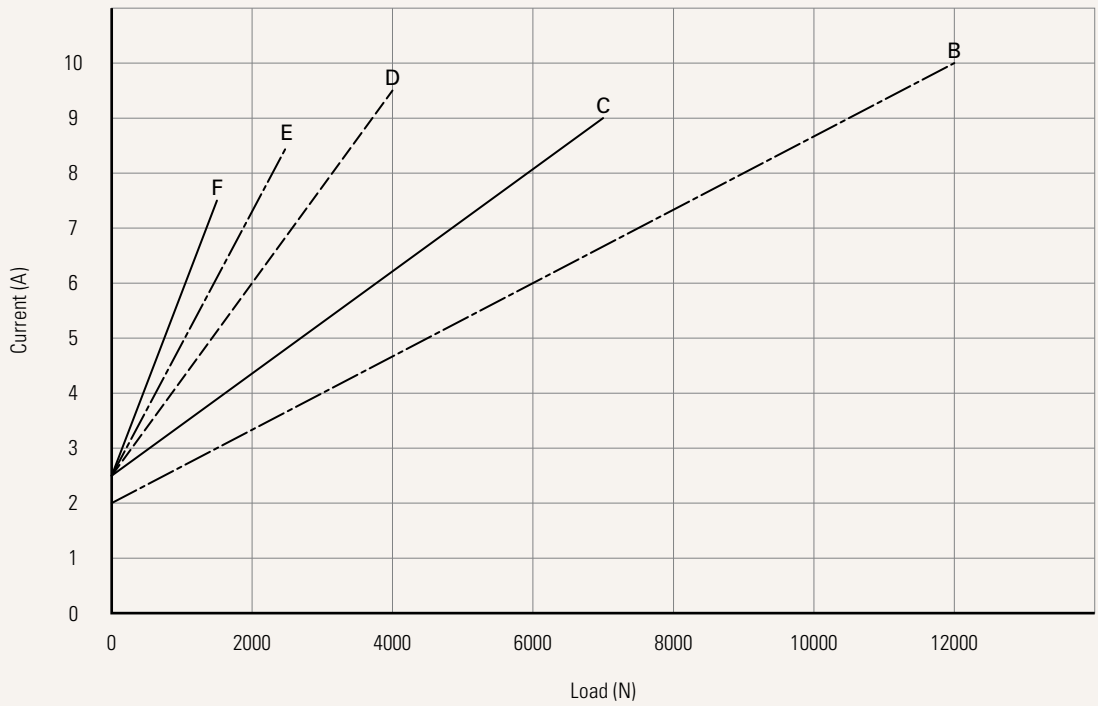

Performance Data (24V DC Motor)

Motor Speed (3000RPM, Duty Cycle 10%)

Speed vs. Load

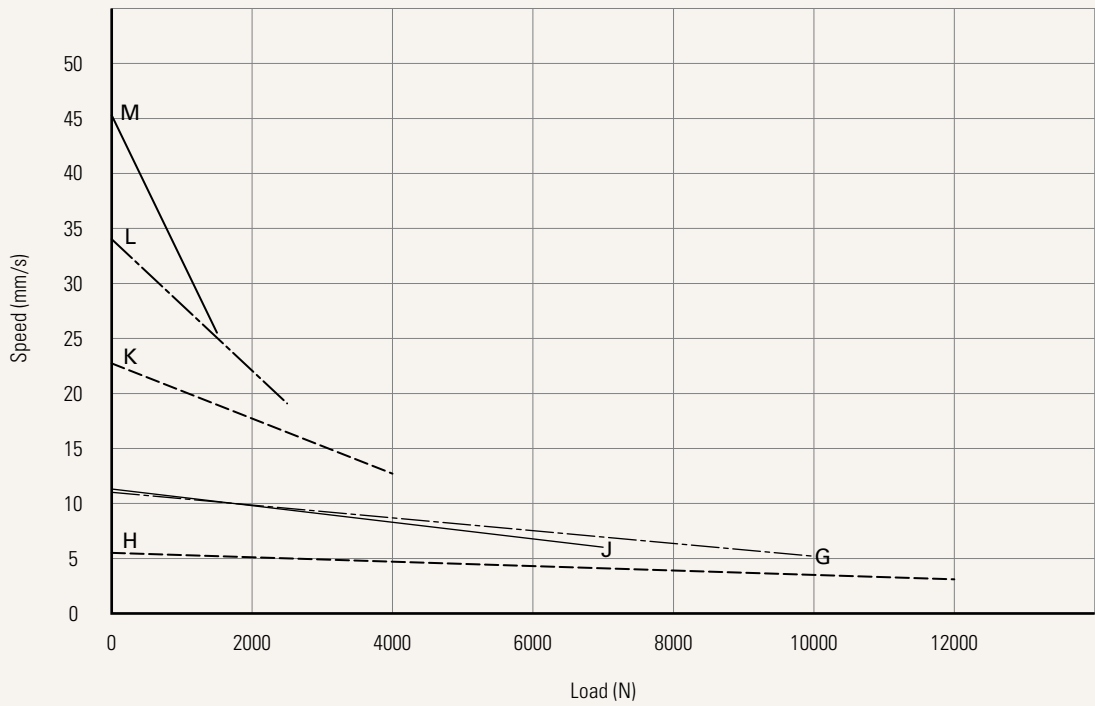

Current vs. Load

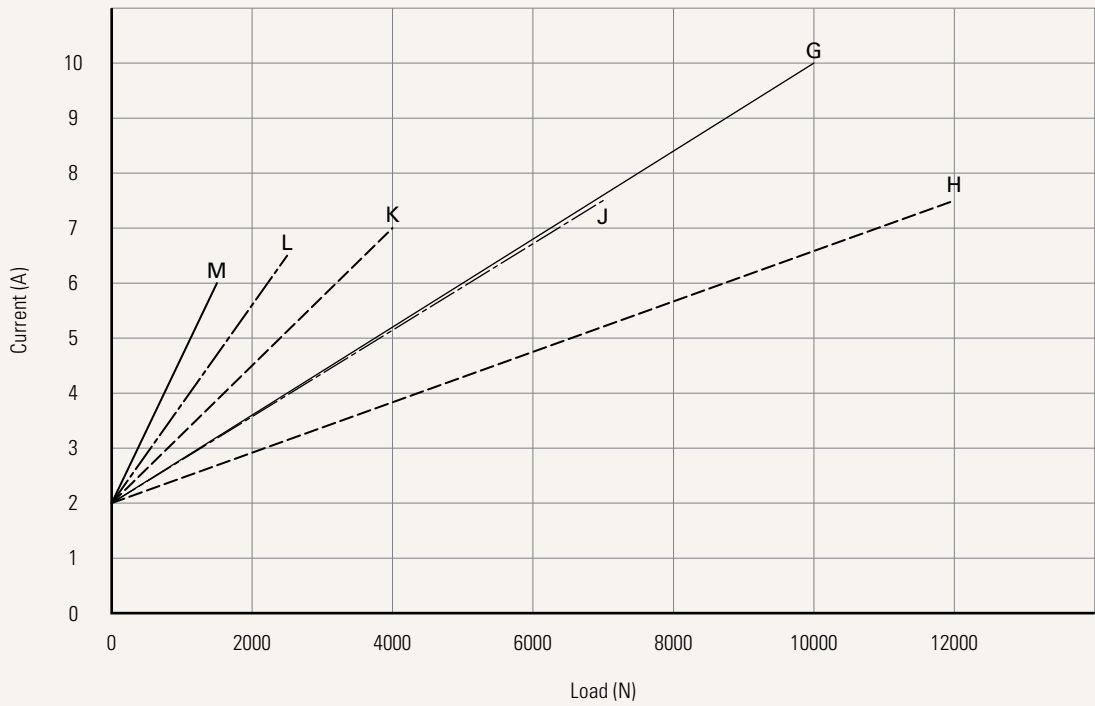

Voltage	5 = 24V DC, PTC	6 = 12V DC, PTC		
Load and Speed	See page 2			
Stroke (mm)				
Retracted Length (mm)	See page 7			
Rear Attachment (mm)	1 = Iron CNC, U clevis, slot 8.2, depth 17.0, hole 10.2, with plastic T-bushing	2 = Iron CNC, U clevis, slot 8.2, depth 17.0, hole 12.2	6 = Aluminum casting, U clevis, slot 8.2, depth 17.0, hole 10.2, for load < 8000N	7 = Aluminum casting, U clevis, slot 8.2, depth 17.0, hole 12.2, for load < 8000N
See page 8			C = Aluminum casting, U clevis, slot 8.2, depth 17.0, hole 10.2, with plastic T-bushing, for load < 8000N	
Front Attachment (mm)	1 = Iron CNC, U clevis, slot 8.2, depth 17.0, hole 10.2, with plastic T-bushing	2 = Iron CNC, U clevis, slot 8.2, depth 17.0, hole 12.2	6 = Aluminum casting, U clevis, slot 8.2, depth 15.0, hole 10.2, for load < 8000N	7 = Aluminum casting, U clevis, slot 8.2, depth 15.0, hole 12.2, for load < 8000N
See page 8			C = Aluminum casting, U clevis, slot 8.2, depth 15.0, hole 10.2, with plastic T-bushing, for load < 8000N	
Direction of Rear Attachment (Counterclockwise)	1 = 0°	3 = 90°		
See page 9				
Color	1 = Black	2 = Pantone 428C		
IP Rating	1 = Without	2 = IP54	3 = IP66	5 = IP66W
Emergency Release Function	0 = Without	1 = Cable type quick release (not including cable)		
Special Functions for Spindle Sub-Assembly	0 = Without (Standard)	1 = Safety nut		2 = Standard push only 3 = Standard push only + safety nut
Functions for Limit Switches	1 = Two switches at full retracted / extended positions to cut current			
See page 9	3 = Two switches at full retracted / extended positions to send signal			
Output Signals	0 = Without	2 = Hall sensor * 2	P = POT	
Connector	1 = DIN 6P, 90° plug	F = DIN 6P, 180° plug, for TEC extension cable standard option		
See page 9	2 = Tinned leads	G = Audio plug		
Cable Length (mm)	1 = Straight, 500	3 = Straight, 1000	5 = Straight, 1500	7 = Curly, 200
	2 = Straight, 750	4 = Straight, 1250	6 = Straight, 2000	8 = Curly, 400

Voltage	5 = 24V DC, thermal protector	
Load and Speed	B = 12000N	G = 10000N
Stroke (mm)		
Retracted Length (mm)	See page 7	
Rear Attachment (mm)	C = Aluminum casting, clevis U, slot 8.2, depth 17.0, hole 10.2, T-bushing See page 8	
Front Attachment (mm)	F = Aluminum casting, clevis U, slot 8.2, depth 19.0, hole 10.2, T-bushing, for manual release See page 8	
Direction of Rear Attachment (Counterclockwise)	1 = 0° See page 9	
Color	1 = Black	2 = Pantone 428C
IP Rating	2 = IP54	3 = IP66
Emergency Release Function	5 = Manual release	
Special Functions for Spindle Sub-Assembly	6 = Mechanical push only + safety nut	
Functions for Limit Switches	1 = Two switches at full retracted / extended positions to cut current See page 9	
Output Signals	0 = Without	
Connector	1 = DIN 6P, 90° plug See page 9 F = DIN 6P, 180° plug, for TEC extension cable standard option G = Audio plug	
Cable Length (mm)	1 = Straight, 500	3 = Straight, 1000

Retracted Length (mm)

1. Calculate $A+B+C = Y$
2. Retracted length needs to \geq Stroke + Y

A. Front Attachment

CODE	General	For Patient Hoist
1, 2, 3, 4	+220	-
6, 7, 8, 9, C for load < 8000N	+210	-
E	+270	-
F	-	+267

C. Spindle Sub-Assembly (Push Only)

CODE	General	For Patient Hoist
0	-	-
1	-	-
2	+15	-
3	+15	-
6	-	+15

B. Stroke

Stroke (mm)	General	For Patient Hoist
25~300	-	-
301~350	+10	+10
351~400	+20	+20

* For stroke over 400mm, + 10mm for each increment of 50mm stroke.

Rear Attachment (mm)

1 = Iron CNC, U clevis, slot 8.2, depth 17.0, hole 10.2, with plastic T-bushing

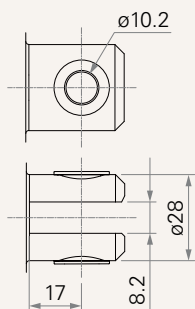

2 = Iron CNC, U clevis, slot 8.2, depth 17.0, hole 12.2

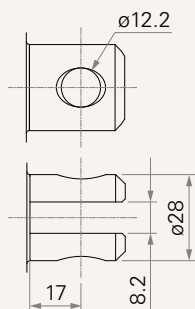

6 = Aluminum casting, U clevis, slot 8.2, depth 17.0, hole 10.2, for load < 8000N

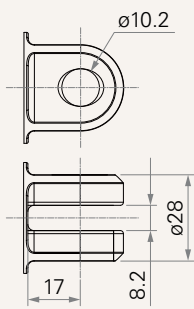

7 = Aluminum casting, U clevis, slot 8.2, depth 17.0, hole 12.2, for load < 8000N

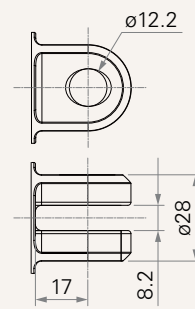

C = Aluminum casting, U clevis, slot 8.2, depth 17.0, hole 10.2, with plastic T-bushing, for load < 8000N

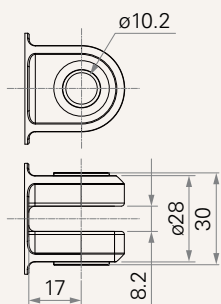

Front Attachment (mm)

1 = Iron CNC, U clevis, slot 8.2, depth 17.0, hole 10.2, with plastic T-bushing

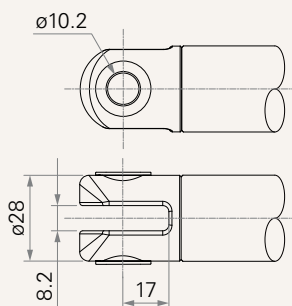

2 = Iron CNC, U clevis, slot 8.2, depth 17.0, hole 12.2

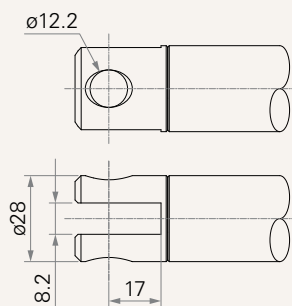

6 = Aluminum casting, U clevis, slot 8.2, depth 15.0, hole 10.2, for load < 8000N

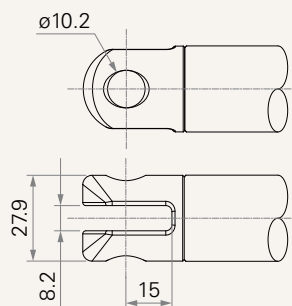

7 = Aluminum casting, U clevis, slot 8.2, depth 15.0, hole 12.2, for load < 8000N

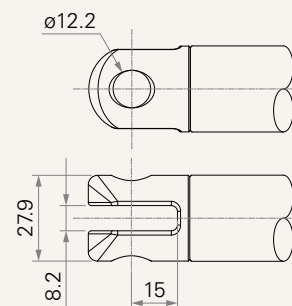

C = Aluminum casting, U clevis, slot 8.2, depth 15.0, hole 10.2, with plastic T-bushing, for load < 8000N

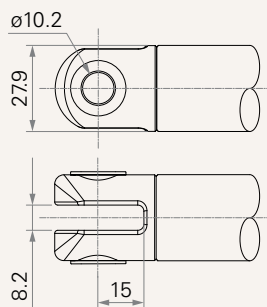

F = Aluminum casting, clevis U, slot 8.2, depth 19.0, hole 10.2, T-bushing, for manual release

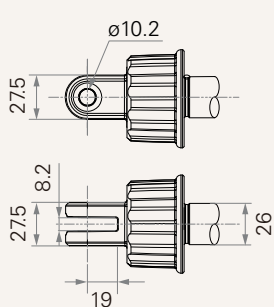

Direction of Rear Attachment (Counterclockwise)

1 = 0°

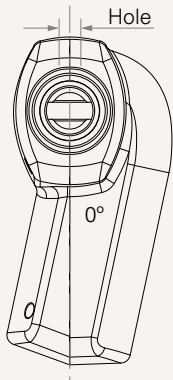

3 = 90°

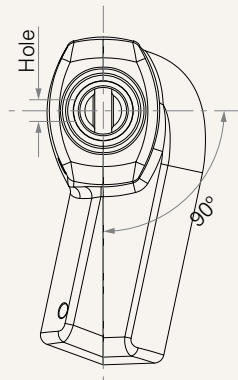

Functions for Limit Switches

Wire Definitions

CODE	Pin					
	● 1 (Green)	● 2 (Red)	○ 3 (White)	● 4 (Black)	● 5 (Yellow)	● 6 (Blue)
1	extend (VDC+)	N/A	N/A	N/A	retract (VDC+)	N/A
3	extend (VDC+)	common	upper limit switch	N/A	retract (VDC+)	lower limit switch

Connector

1 = DIN 6P, 90° plug

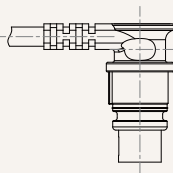

2 = Tinned leads

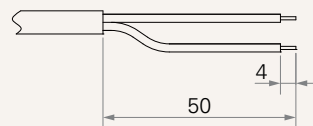

F = DIN 6P, 180° plug, for TEC extension cable standard option



G = Audio plug



Terms of Use

The user is responsible for determining the suitability of TiMOTION products for a specific application. TiMOTION products are subject to change without prior notice.