

TA2

series

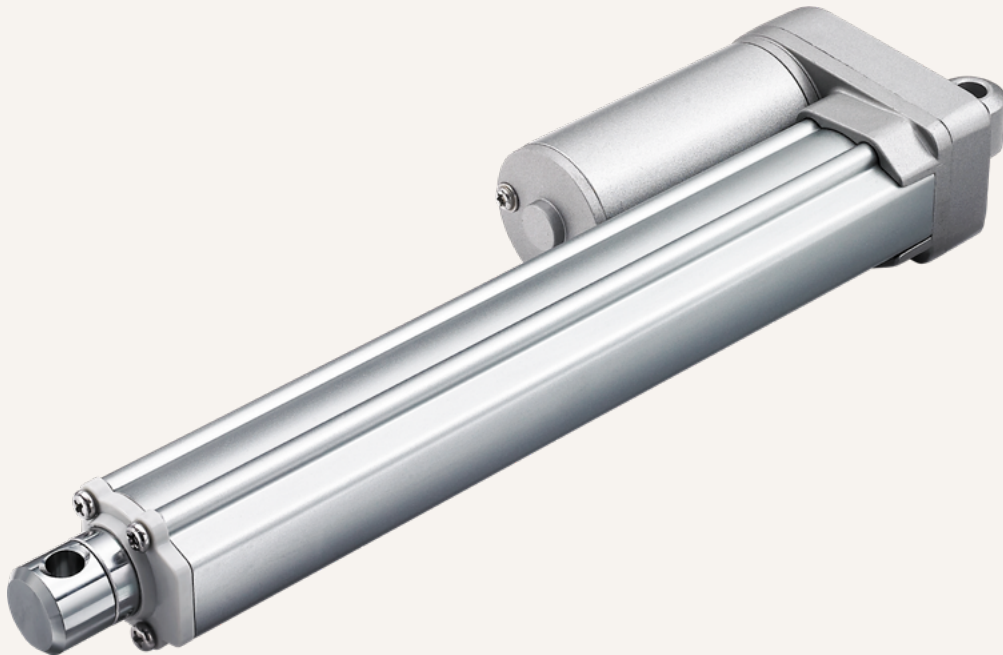

Product Segments

- **Industrial Motion**

TiMOTION's TA2 series linear actuator is compact, robust and capable of performing well in certain outdoor environments. This linear actuator is perfect for use in small spaces where force or capability cannot be sacrificed. Options include feedback sensors, signal sending limit switches and 90 degree clevis mounting.

General Features

Max. load	1,000N (push/pull)
Max. speed at max. load	7.6mm/s
Max. speed at no load	67.5mm/s
Retracted length	≥ Stroke + 105mm (without output signals)
IP rating	IP66D
Certificate	EMC
Stroke	20~1000mm
Output signals	POT, Reed, Hall sensors
Voltage	12 / 24 / 36 / 48V DC; 12 / 24 / 36 / 48V DC (PTC)
Color	Silver
Operational temperature range	+5°C~+45°C (Load < 500N); -25°C~+65°C (Load ≥ 500N)
Operational temperature range at full performance	+5°C~+45°C

Drawing

Dimensions without
Output Signals
(mm)

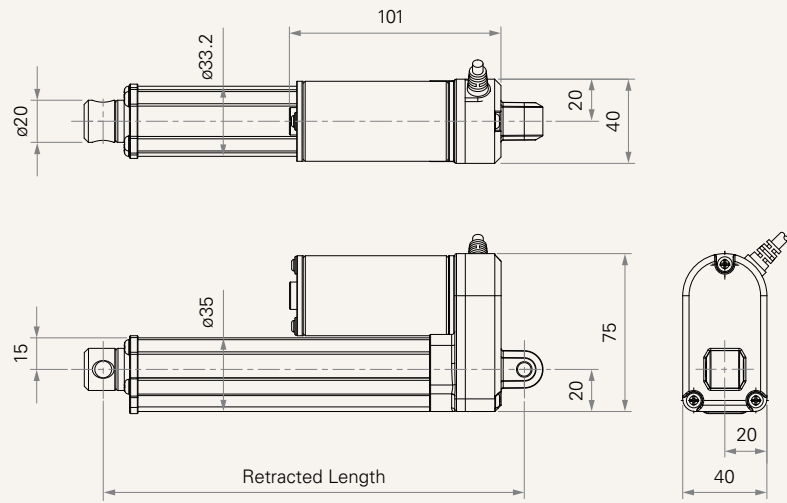

Dimensions with
Output Signals
(mm)

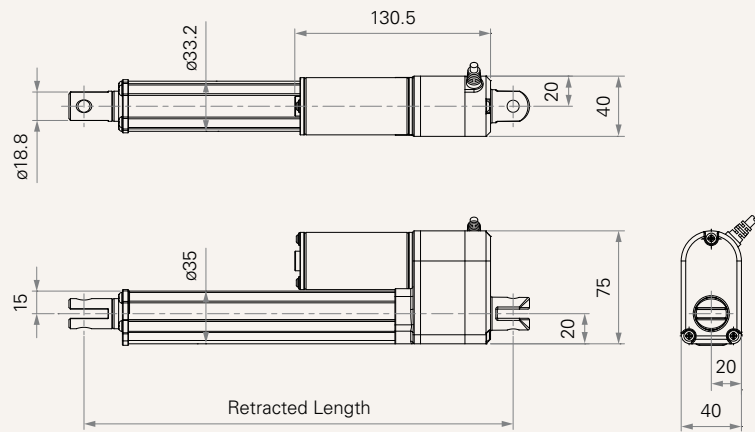

Load and Speed

CODE	Load (N)		Self Locking Force (N)	Typical Current (A)		Typical Speed (mm/s)	
	Push	Pull		No Load 24V DC	With Load 24V DC	No Load 24V DC	With Load 24V DC
Motor Speed (4200RPM, duty cycle 25%)							
A	120	120	120	0.8	1.0	44.0	33.0
B	240	240	240	0.7	1.0	22.0	16.5
C	500	500	500	0.6	0.9	11.0	8.5
D	750	750	750	0.6	0.9	7.5	6.2
E	1000	1000	1000	0.6	0.9	5.6	4.6
Motor Speed (6000RPM, duty cycle 25%)							
F	120	120	120	1.0	1.8	67.5	51.0
G	240	240	240	0.9	1.7	33.5	26.5
H	500	500	500	0.8	1.5	17.0	14.0
K	750	750	750	0.8	1.5	11.0	10.0
L	1000	1000	1000	0.8	1.5	9.0	7.6

Note

- 1 Please refer to the approved drawing for the final authentic value.
- 2 This self-locking force level is reached only when a short circuit is applied on the terminals of the motor. All the TiMOTION control boxes have this feature built-in.
- 3 The current & speed in table are tested with 24V DC motor. With a 12V DC motor, the current is approximately twice the current measured in 24V DC. With a 36V DC motor, the current is approximately two-thirds the current measured in 24V DC. With a 48V DC motor, the current is approximately half the current measured in 24V DC. Speed will be similar for all the voltages.
- 4 The current & speed in table are tested when the actuator is extending under push load.
- 5 The current & speed in table and diagram are tested with a stable 24V DC power supply.
- 6 With load, noise level ≤ 74 dBA (by TiMOTION test standard, ambient noise level ≤ 36 dBA)

CODE	Load (N)	Max Stroke (mm)
A, B, F, G	≤ 250	1000
C, D, H, K	≤ 750	800
E, L	≤ 1000	600

Performance Data (24V DC)

Motor Speed (4200RPM, duty cycle 25%)

Speed vs. Load

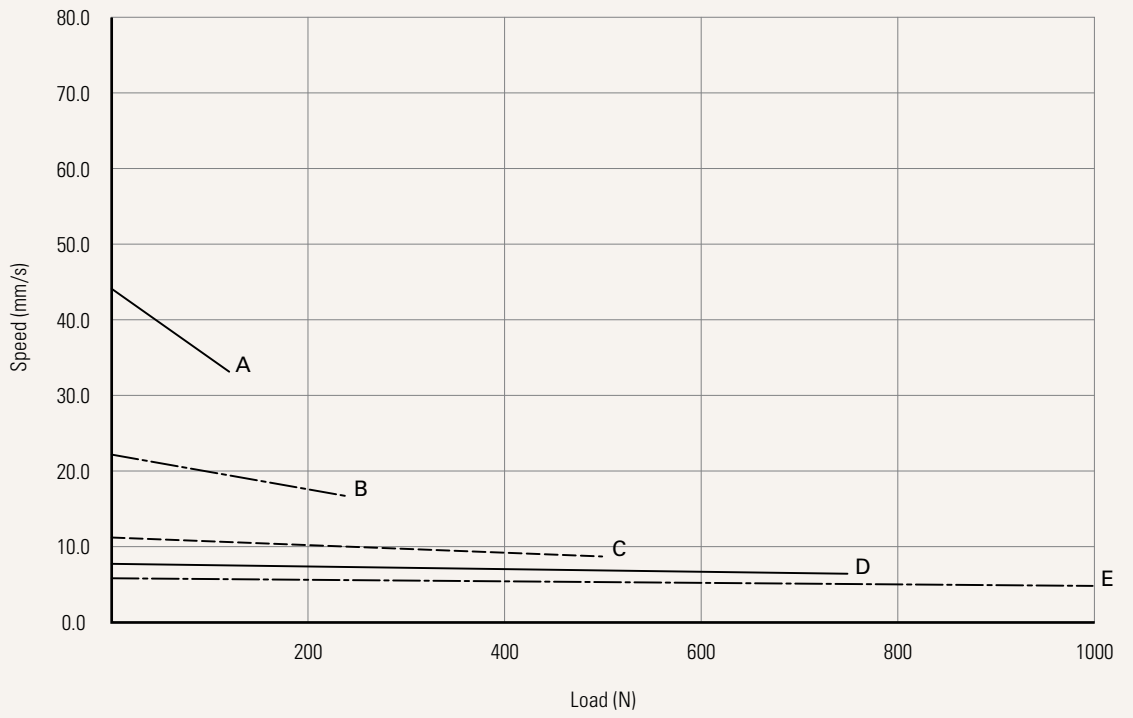

Current vs. Load

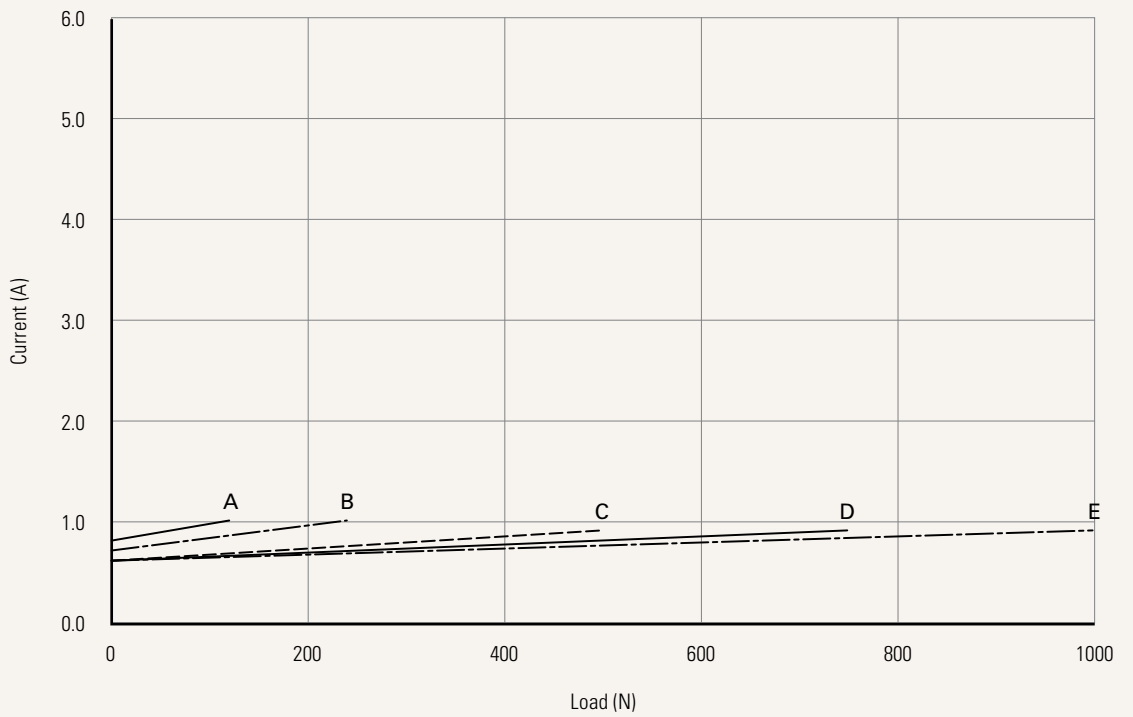

Performance Data (24V DC)

Motor Speed (6000RPM, duty cycle 25%)

Speed vs. Load

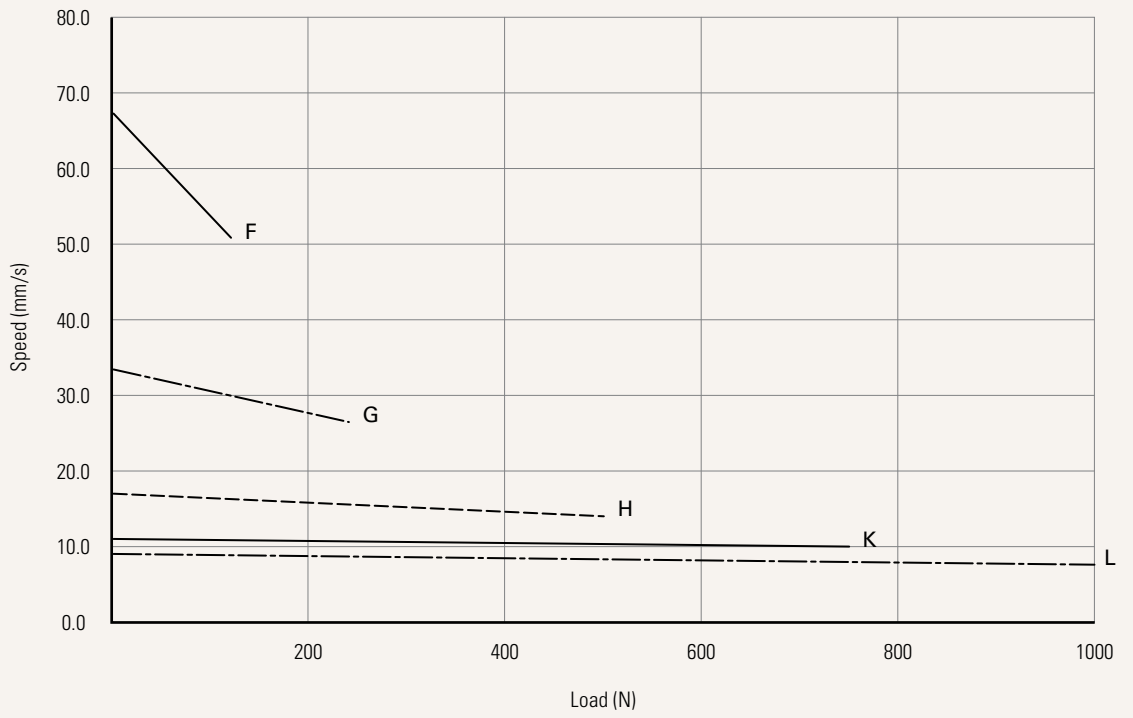

Current vs. Load

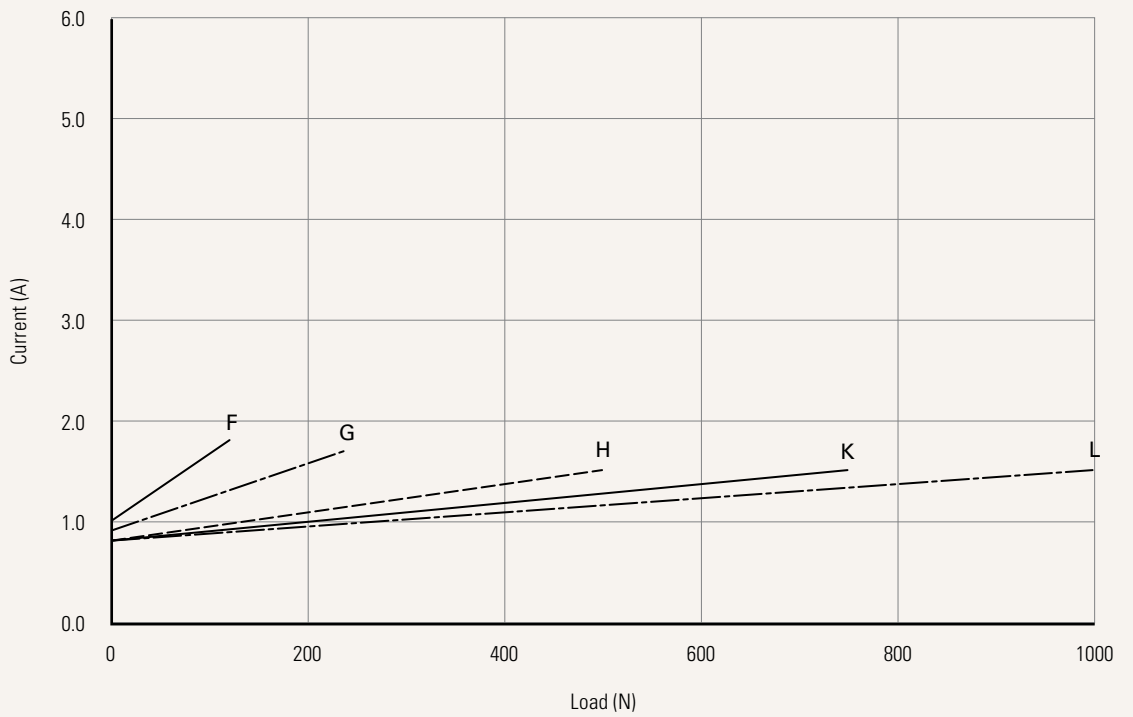

Voltage	1 = 12V DC 2 = 24V DC	3 = 36V DC 4 = 48V DC	5 = 24V DC, PTC 6 = 12V DC, PTC	7 = 36V DC, PTC 8 = 48V DC, PTC
Load and Speed	See page 3			
Stroke (mm)	See page 3			
Retracted Length (mm)	See page 7			
Rear Attachment (mm) See page 8	1 = Aluminum, slotless, hole 6.4, one piece casting with gear box 2 = Aluminum, slotless, hole 8.0, one piece casting with gear box 3 = Aluminum, slotless, hole 10.0, one piece casting with gear box	4 = Aluminum, U clevis, slot 6.0, depth 10.5, hole 6.4, one piece casting with gear box 5 = Aluminum, U clevis, slot 6.0, depth 10.5, hole 8.0, one piece casting with gear box 6 = Aluminum, U clevis, slot 6.0, depth 10.5, hole 10.0, one piece casting with gear box		
Front Attachment (mm) See page 9	1 = Aluminum, slotless, hole 6.4 2 = Aluminum, slotless, hole 8.0 3 = Aluminum, U clevis, slot 6.0, depth 16.0, hole 10.0	4 = Aluminum, U clevis, slot 6.0, depth 16.0, hole 6.4 5 = Aluminum, U clevis, slot 6.0, depth 16.0, hole 8.0 6 = Aluminum, slotless, hole 10.0		
Direction of Rear Attachment (Counterclockwise) See page 9	1 = 90°	2 = 0°		
Functions for Limit Switches See page 10	1 = Two switches at full retracted / extended positions to cut current 2 = Two switches at full retracted / extended positions to cut current + third one in between to send signal 3 = Two switches at full retracted / extended positions to send signal 4 = Two switches at full retracted / extended positions to send signal + third one in between to send signal			
Output Signal	0 = Without	1 = POT	3 = Reed sensor	5 = Hall sensor*2
Connector See page 10	1 = DIN 6P, 90° plug	2 = Tinned leads		
Cable Length (mm)	1 = Straight, 300	2 = Straight, 600	3 = Straight, 1000	
IP Rating	1 = Without	2 = IP54	3 = IP66	6 = IP66D

Retracted Length (mm)

1. Calculate $A+B+C = Y$
2. Retracted length needs to \geq Stroke + Y

A. Rear / Front Attachment		
Front Attachment	Rear Attachment	
	1, 2, 3	4, 5, 6
1, 2, 6	+105	+109
3, 4, 5	+115	+119

B. Stroke (mm)	
20~150	-
151~200	+2
201~250	+2
251~300	+2
301~350	+12
351~400	+22
401~450	+32
451~500	+42
501~550	+52
551~600	+62
601~650	+72
651~700	+82
701~750	+92
751~800	+102
801~850	+112
851~900	+122
901~950	+132
951~1000	+142

C. Output Signal	
CODE	
0	-
1, 3, 4, 5	+30

Voltage

5 = 24V DC, PTC

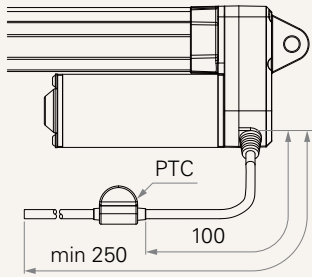

6 = 12V DC, PTC

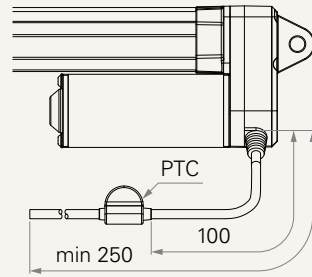

Rear Attachment (mm)

1 = Aluminum, slotless, hole 6.4, one piece casting with gear box

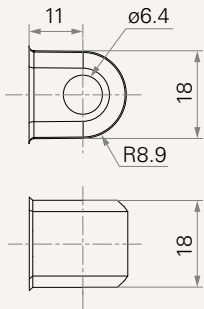

2 = Aluminum, slotless, hole 8.0, one piece casting with gear box

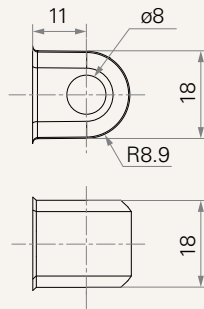

3 = Aluminum, slotless, hole 10.0, one piece casting with gear box

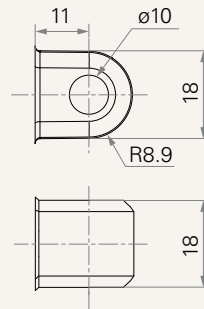

4 = Aluminum, U clevis, slot 6.0, depth 10.5, hole 6.4, one piece casting with gear box

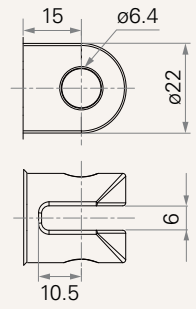

5 = Aluminum, U clevis, slot 6.0, depth 10.5, hole 8.0, one piece casting with gear box

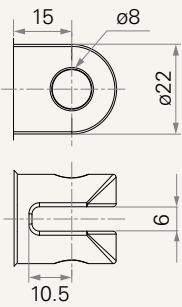

6 = Aluminum, U clevis, slot 6.0, depth 10.5, hole 10.0, one piece casting with gear box

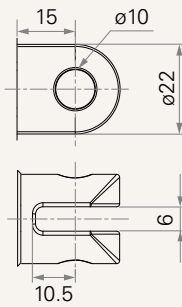

Front Attachment (mm)

1 = Aluminum, slotless, hole 6.4

2 = Aluminum, slotless, hole 8.0

6 = Aluminum, slotless, hole 10.0

3 = Aluminum, U clevis, slot 6.0, depth 16.0, hole 10.0

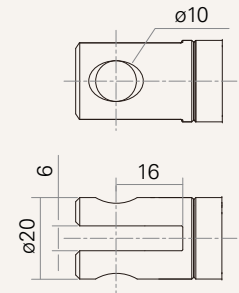
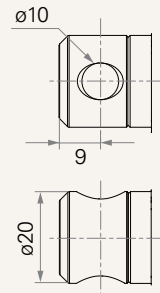
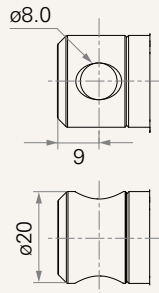
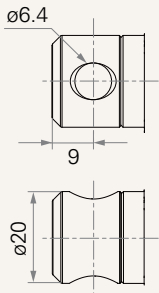

4 = Aluminum, U clevis, slot 6.0, depth 16.0, hole 6.4

5 = Aluminum, U clevis, slot 6.0, depth 16.0, hole 8.0

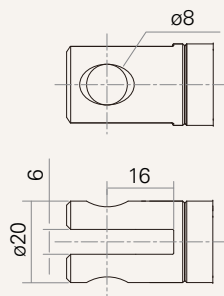
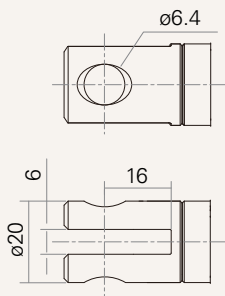

Direction of Rear Attachment (Counterclockwise)

1 = 90°

2 = 0°

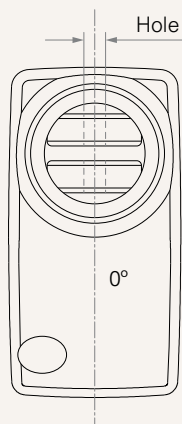
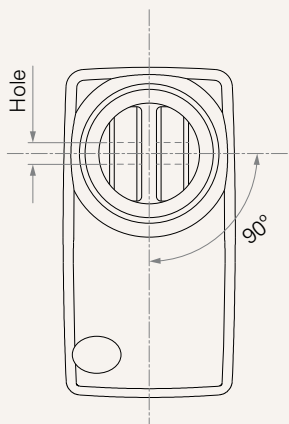

Functions for Limit Switches

Wire Definitions

CODE	Pin					
	● 1 (Green)	● 2 (Red)	○ 3 (White)	● 4 (Black)	● 5 (Yellow)	● 6 (Blue)
1	extend (VDC+)	N/A	N/A	N/A	retract (VDC+)	N/A
2	extend (VDC+)	N/A	middle switch pin B	middle switch pin A	retract (VDC+)	N/A
3	extend (VDC+)	common	upper limit switch	N/A	retract (VDC+)	lower limit switch
4	extend (VDC+)	common	upper limit switch	medium limit switch	retract (VDC+)	lower limit switch

Connector

1 = DIN 6P, 90° plug

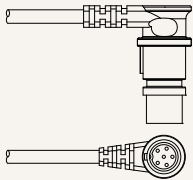

2 = Tinned leads

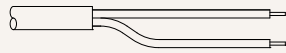

Terms of Use

The user is responsible for determining the suitability of TiMOTION products for a specific application. TiMOTION products are subject to change without prior notice.