

TA23

series



Product Segments

- **Care Motion**

TiMOTION's TA23 series is a compact linear actuator primarily used for medical applications that require high force and high speed. This linear actuator also has the ability to save installation space by mounting the control box to the actuator. The TA23 linear actuator is available with IP rating up to IP66W. It also has Hall sensors for position feedback. The TA23 also has manual release option which can be used for patient hoist applications.

General Features

Max. load	10,000N (push); 4,000N (pull)
Max. speed at max. load	3.2mm/s
Max. speed at no load	39mm/s
Retracted length	≥ Stroke + 163mm
IP rating	IP66W
Certificate	IEC60601-1, ES60601-1, IEC60601-1-2, EMC
Stroke	25~1000mm
Output signals	Hall sensors
Options	Manual release (for patient hoist)
Voltage	12/24/36V DC; 24V DC (PTC)
Color	Black, grey
Operational temperature range	+5°C~+45°C
Suitable for patient hoist application	

Drawing

Standard Dimensions
(mm)

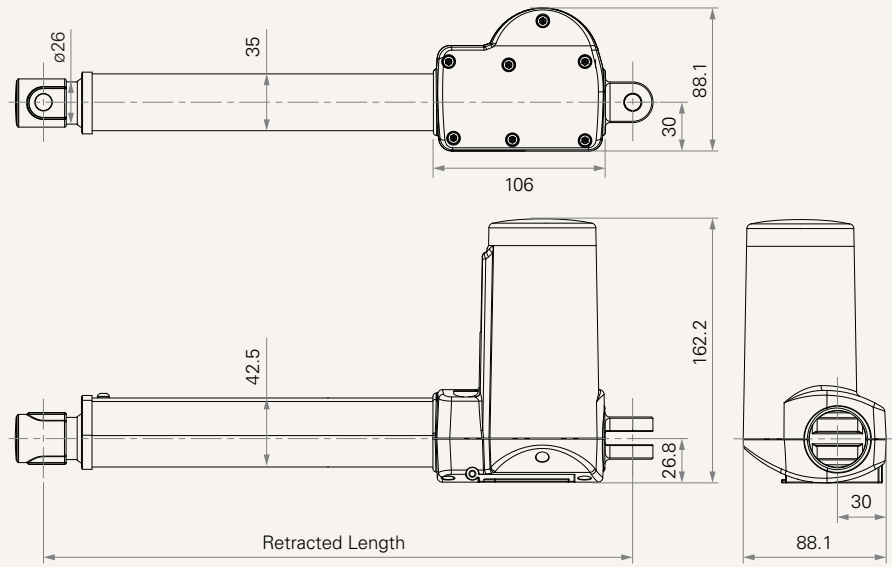

Load and Speed

CODE	Load (N)		Self Locking Force (N)	Typical Current (A)		Typical Speed (mm/s)	
	Push	Pull		No Load 32V DC	With Load 24V DC	No Load 32V DC	With Load 24V DC
Motor Speed (2600RPM, Duty Cycle 10%)							
C	5000	4000	5000	0.8	3.5	8.0	4.1
D	6000	4000	6000	0.8	3.5	6.0	3.1
E	3500	3500	3500	0.8	3.1	10.7	5.6
F	2500	2500	2500	0.8	3.2	15.9	8.3
G	2000	2000	2000	0.8	2.8	21.4	12.1
H	1000	1000	1000	0.8	2.1	32.1	19.1
J	3500	3500	3500	0.8	3.6	11.9	6.0
K	8000	4000	8000	0.8	4.2	5.4	2.6
Motor Speed (3400RPM, Duty Cycle 10%)							
L	6000	4000	6000	1.0	4.2	7.3	4.1
M	3500	3500	3500	1	3.8	13.1	7.5
N	2500	2500	2500	1.0	4.1	19.4	11.1
O	2000	2000	2000	1.0	4.0	26.1	14.9
P	1000	1000	1000	1.0	3.0	39.0	23.4
Q	3500	3500	3500	1.0	4.6	14.5	7.9
R	8000	4000	8000	1.0	5.2	6.6	3.4
T	5000	4000	5000	1.0	4.2	9.8	5.4
Motor Speed (3800RPM, Duty Cycle 10%)							
X	6000	4000	6000	1.2	4.4	8.6	5.0
Y	8000	4000	8000	1.2	5.5	7.7	4.3
B	10000	4000	10000	1.2	5.3	5.7	3.2
U	5000	4000	5000	1.2	4.7	11.3	6.6
W	2500	2500	2500	1.2	4.6	23.0	13.4
Z	3500	3500	3500	1.2	5.3	16.8	9.8

Note

- 1 Please refer to the approved drawing for the final authentic value.
- 2 The current & speed in table are tested with 24V DC motor. With a 12V DC motor, the current is approximately twice the current measured in 24V DC; speed will be similar for both voltages.
- 3 This self-locking force level is reached only when a short circuit is applied on the terminals of the motor. All the TiMOTION control boxes have this feature built-in.
- 4 Operational temperature range at full performance: +5°C~+45°C
- 5 The current & speed in table are tested when the actuator is extending under push load.
- 6 The current & speed in table and diagram are tested with TiMOTION control boxes, and there will be around 10% tolerance depending on different models of the control box. (Under no load condition, the voltage is around 32V DC. At rated load, the voltage output will be around 24V DC)
- 7 Standard stroke: Min. ≥ 25mm, Max. please refer to below table.

CODE	Load (N)	Max Stroke (mm)
K, R, Y, B	≥ 8000	450
D, L, X	= 6000	600
Others	< 6000	1000

Performance Data (24V DC Motor)

Motor Speed (2600RPM, Duty Cycle 10%)

Speed vs. Load

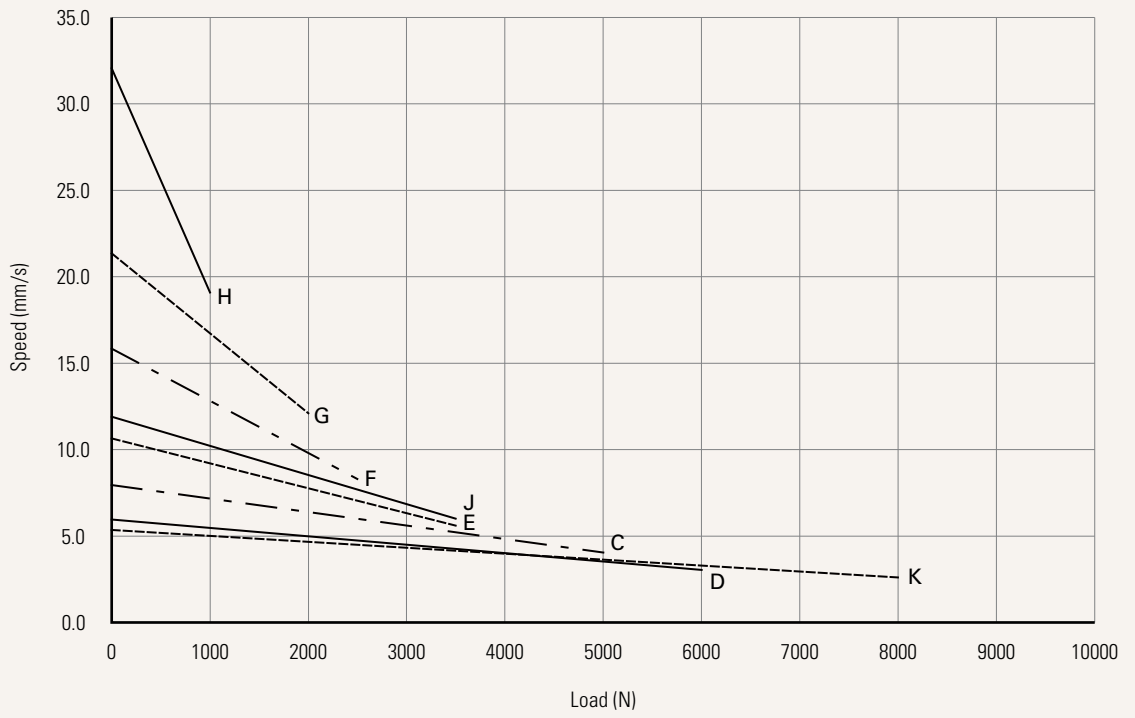

Current vs. Load

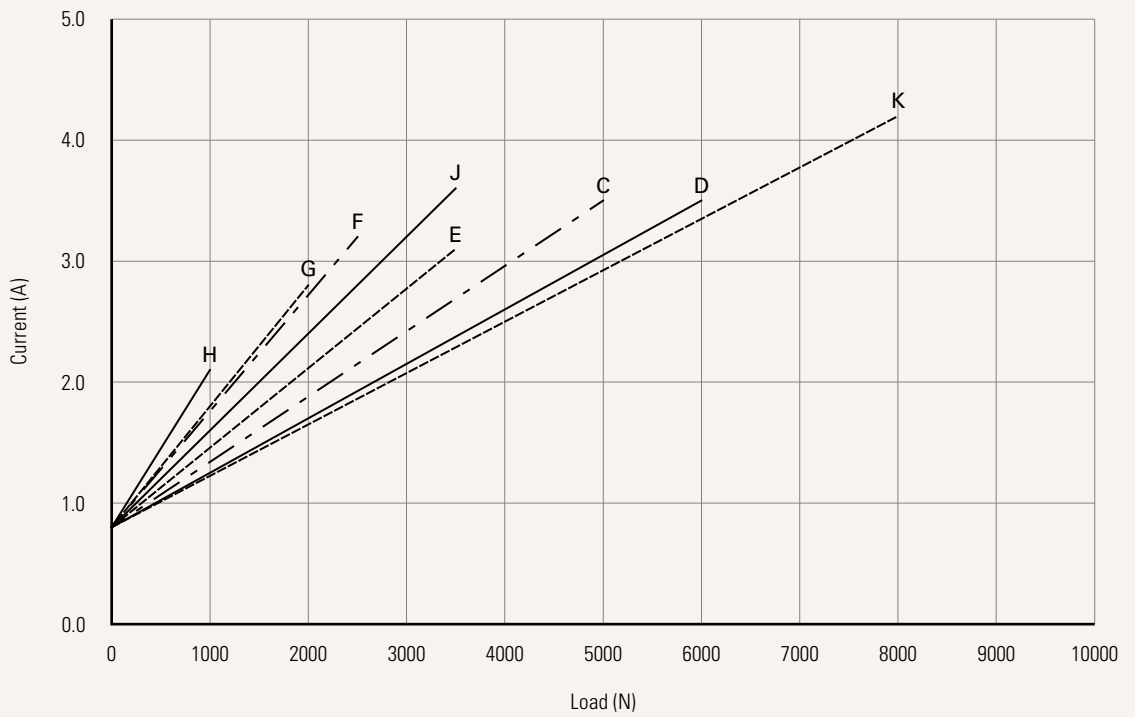

Performance Data (24V DC Motor)

Motor Speed (3400RPM, Duty Cycle 10%)

Speed vs. Load

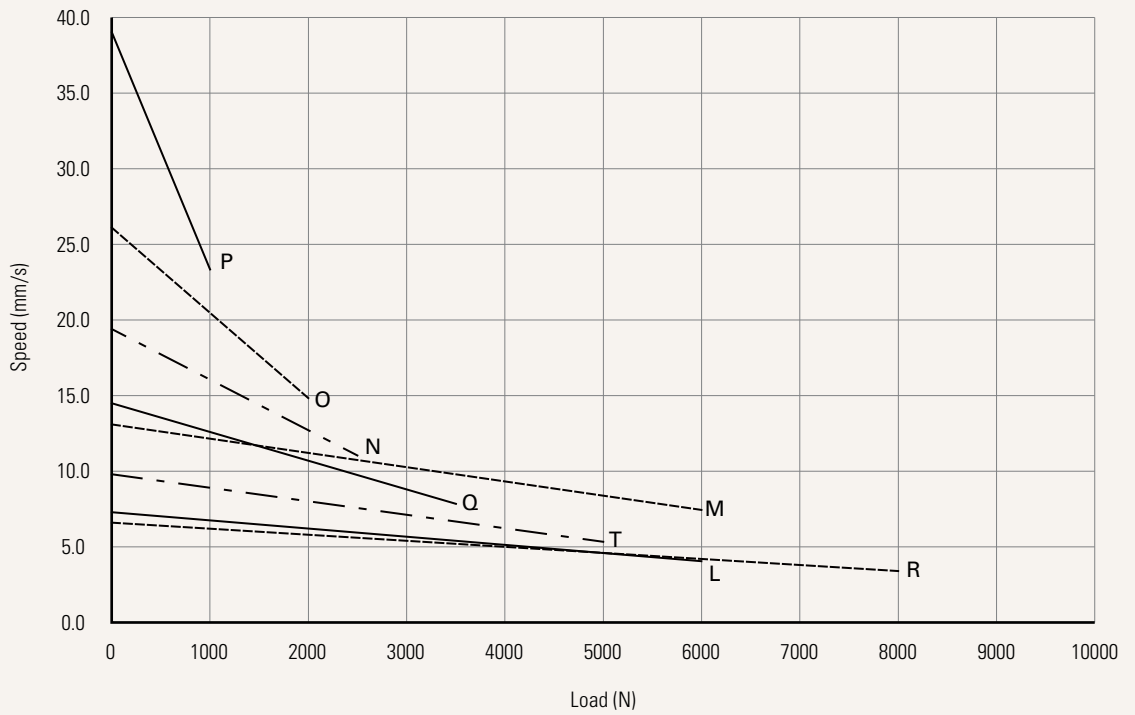

Current vs. Load

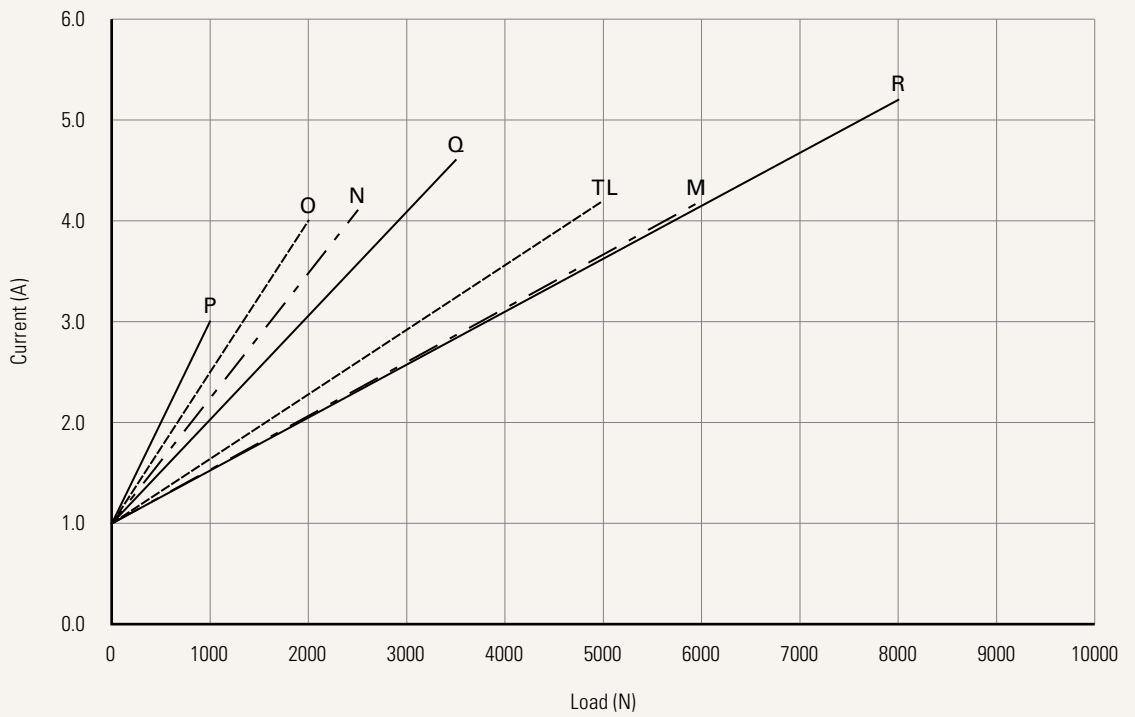

Performance Data (24V DC Motor)

Motor Speed (3800RPM, Duty Cycle 10%)

Speed vs. Load

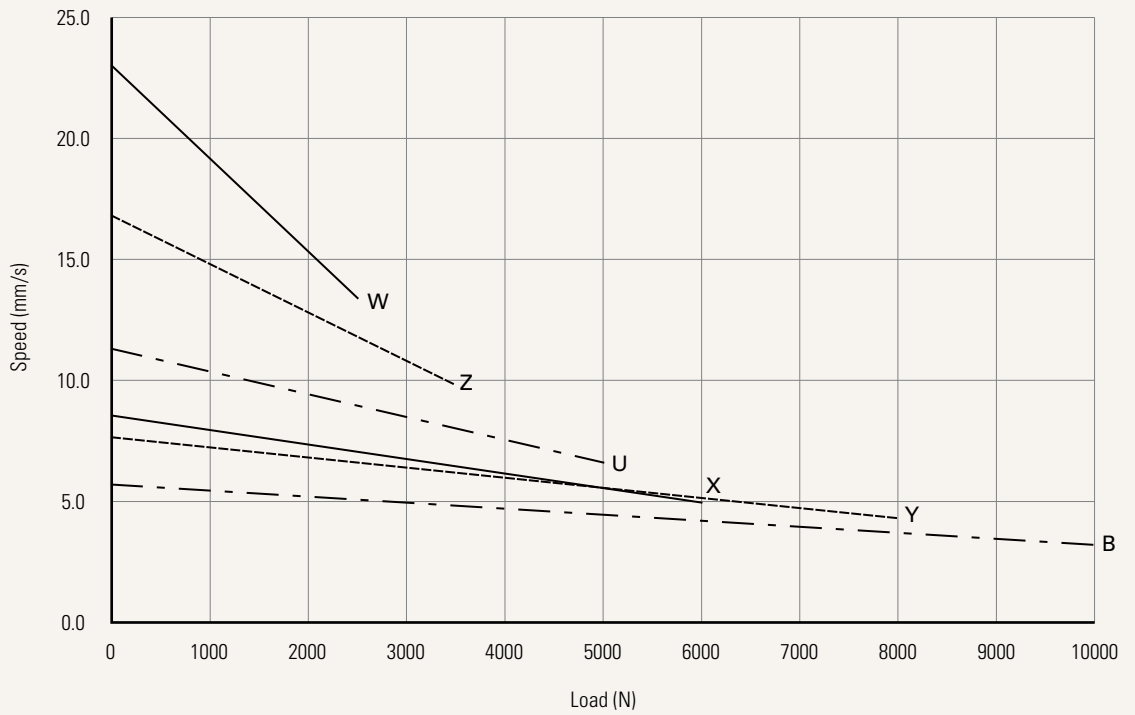

Current vs. Load

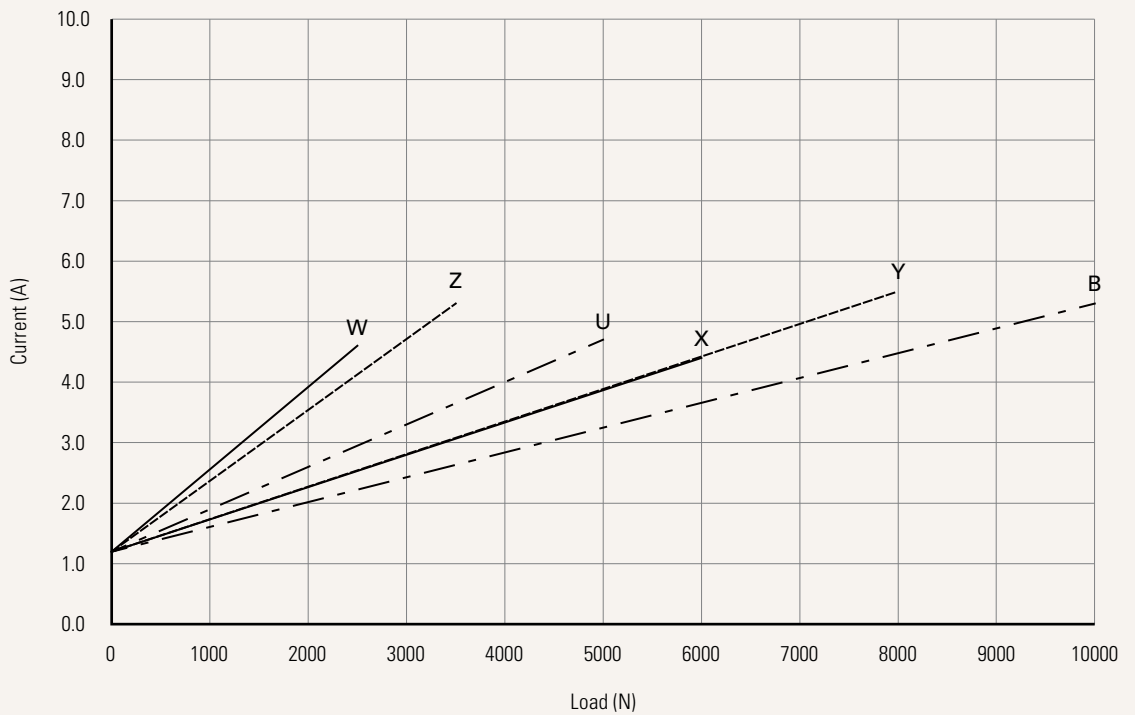

Voltage	1 = 12V DC	2 = 24V DC	3 = 36V DC	5 = 24V DC, PTC
Load and Speed	See page 3			
Stroke (mm)	See page 3			
Retracted Length (mm)	See page 9			
Rear Attachment (mm) See page 10	2 = Aluminum casting, U clevis, slot 8.2, depth 17.0, hole 10.2 3 = Aluminum casting, U clevis, slot 8.2, depth 17.0, hole 12.2 C = Aluminum casting, U clevis, slot 8.2, depth 17.0, hole 10.2, with plastic T-bushing			
Front Attachment (mm) See page 10	1 = Punched hole on inner tube + plastic cap, without slot, hole 10.2, with plastic bushing 2 = Punched hole on inner tube + plastic cap, without slot, hole 12.2 3 = Plastic, U clevis, slot 8.2, depth 20.0, hole 10.2 (for load push < 4000N & pull < 2500N) 4 = Plastic, U clevis, slot 8.2, depth 20.0, hole 12.2 (for load push < 4000N & pull < 2500N)		5 = Punched hole on inner tube, without slot, hole 10.2, with plastic bushing 6 = Punched hole on inner tube, without slot, hole 12.2 7 = Aluminum casting, U clevis, slot 6.2, depth 17.0, hole 10.2 8 = Aluminum casting, U clevis, slot 6.2, depth 17.0, hole 12.2 9 = Aluminum casting, U clevis, slot 6.2, depth 17.0, hole 10.2, with plastic T-bushing J = Aluminum casting, without slot, hole 10.2, for dental chair	
Direction of Rear Attachment (Counterclockwise) See page 11	1 = 0°		3 = 90°	
Color	1 = Black		2 = Pantone 428C	
IP Rating	1 = Without		2 = IP54	
			3 = IP66	
			5 = IP66W	
Special Functions for Spindle Sub-Assembly	0 = Without (Standard)		2 = Standard push only	
	1 = Safety nut		3 = Standard push only + safety nut	
Functions for Limit Switches See page 11	1 = Two switches at full retracted / extended positions to cut current 2 = Two switches at full retracted / extended positions to cut current + third one in between to send signal 3 = Two switches at full retracted / extended positions to send signal		4 = Two switches at full retracted / extended positions to send signal + third one in between to send signal 5 = Two switches at full retracted/extended positions to send signal (Operate with control box: TC8, TC10, TC14, TC21; compatible with hall sensors)	
Output Signals	0 = Without		2 = Hall sensor * 2	
Connector See page 12	1 = DIN 6P, 90° plug 2 = Tinned leads 4 = Big 01P, plug C = Y cable (for direct cut system, water proof, anti pull) D = Extension cable, not preset on motor cover (cable length 120mm) R = Extension cable, preset on motor cover (cable length 50mm)		E = Molex 8P, plug F = DIN 6P, 180° plug G = Audio plug M = DIN 4P, dental chair plug (40510-143, standard) N = DIN 4P, dental chair plug (40510-040) P = Molex 8P, 90° plug, without anti-clip Q = Molex 6P, 90° plug, without anti-clip	
Cable Length (mm)	0 = Straight, 100		5 = Straight, 1500	
	1 = Straight, 500		6 = Straight, 2000	
	2 = Straight, 750		7 = Curly, 200	
	3 = Straight, 1000		8 = Curly, 400	
	4 = Straight, 1250		B-H = For direct cut system. See page 12 J = For socket attached on motor, not preset attached on motor cover. See page 12 R = For socket attached on motor, preset attached on motor cover. See page 12	

TA23 Patient Hoist Ordering Key

TA23

Version: 20230609-0

Voltage	2 = 24V DC	5 = 24V DC, PTC
Load and Speed	X = 6000N	Y = 8000N
Stroke (mm)	See page 3	
Retracted Length (mm)	See page 9	
Rear Attachment (mm)	C = Aluminum casting, U clevis, slot 8.2, depth 17.0, hole 10.2, with plastic T-bushing See page 10	
Front Attachment (mm)	F = Aluminum casting, U clevis, slot 8.2, depth 19.0, hole 10.2, with T-bushing, manual release See page 10	
Direction of Rear Attachment (Counterclockwise)	1 = 0° See page 11	
Color	1 = Black	2 = Pantone 428C
IP Rating	2 = IP54	3 = IP66
Special Functions for Spindle Sub-Assembly	6 = Mechanical push only + safety nut	
Functions for Limit Switches	1 = Two switches at full retracted / extended positions to cut current See page 11	
Output Signals	0 = Without	
Connector	1 = DIN 6P, 90° plug	F = DIN 6P, 180° plug G = Audio plug See page 12
Cable Length (mm)	1 = Straight, 500	3 = Straight, 1000

Retracted Length (mm)

1. Calculate $A+B+C = Y$
2. Retracted length needs to $\geq \text{Stroke}+Y$

A.

Front Attach.	Rear Attach.	
	General	For Patient Hoist
1, 2, 5, 6	+163	-
3, 4	+188	-
7, 8, 9	+178	-
J	+166	-
F	-	+250

B.

Stroke (mm)	Load (N)				
	General				For Patient Hoist
	< 6000	= 6000	= 8000	= 10000	
25~150	-	-	-	+6	-
151~200	-	-	+5	+11	-
201~250	-	+5	+10	+16	-
251~300	-	+10	+15	+21	+5
301~350	+5	+15	+20	+26	+10
351~400	+10	+20	+25	+31	+15
401~450	+15	+25	+30	+36	+15
451~500	+20	+30	x	x	x
501~550	+25	+35	x	x	x
551~600	+30	+40	x	x	x
601~650	+35	x	x	x	x
651~700	+40	x	x	x	x
701~750	+45	x	x	x	x
751~800	+50	x	x	x	x
801~850	+55	x	x	x	x
851~900	+60	x	x	x	x
901~950	+65	x	x	x	x
951~1000	+70	x	x	x	x

C. Load < 6000 (N)

Front attach.	Spindle Function	
	0, 1	2, 3
1, 2, 5, 6	-	+5
3, 4	-	+5
7, 8, 9	-	+5
J	-	+5
F (For Patient Hoist)	-	-

C. Load = 6000 / 8000 (N)

Front attach.	Spindle Function	
	0, 1	2, 3
1, 2, 5, 6	-	+8
3, 4	-	-
7, 8, 9	-	+8
J	-	+8
F (For Patient Hoist)	-	-

C. Load = 10000 (N)

Front attach.	Spindle Function	
	0, 1	2, 3
1, 2, 5, 6	-	+24
3, 4	-	-
7, 8, 9	-	+16
J	-	+16
F (For Patient Hoist)	-	-

Rear Attachment (mm)

2 = Aluminum casting, U clevis, slot 8.2, depth 17.0, hole 10.2

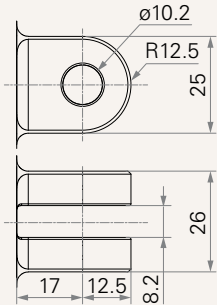

3 = Aluminum casting, U clevis, slot 8.2, depth 17.0, hole 12.2

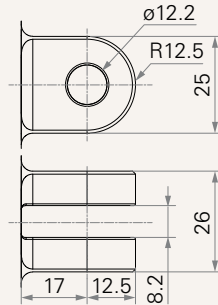

C = Aluminum casting, U clevis, slot 8.2, depth 17.0, hole 10.2, with plastic T-bushing

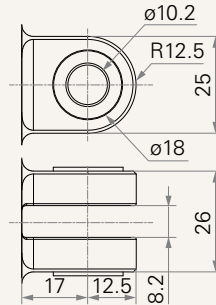

Front Attachment (mm)

1 = Punched hole on inner tube + plastic cap, without slot, hole 10.2, with plastic bushing

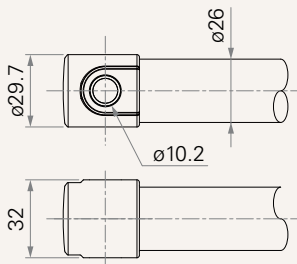

2 = Punched hole on inner tube + plastic cap, without slot, hole 12.2

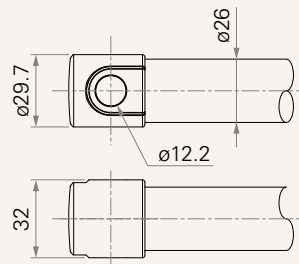

3 = Plastic, U clevis, slot 8.2, depth 20.0, hole 10.2 (for load push < 4000N & pull < 2500N)

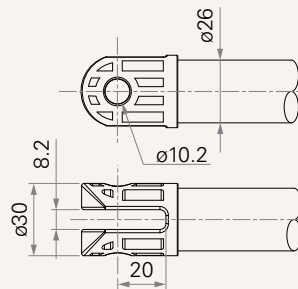

4 = Plastic, U clevis, slot 8.2, depth 20.0, hole 12.2 (for load push < 4000N & pull < 2500N)

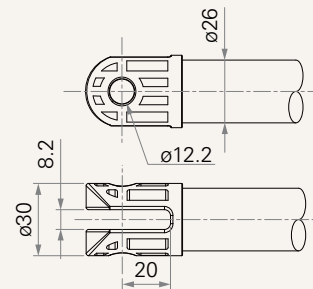

5 = Punched hole on inner tube, without slot, hole 10.2, with plastic bushing

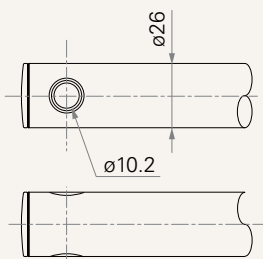

6 = Punched hole on inner tube, without slot, hole 12.2

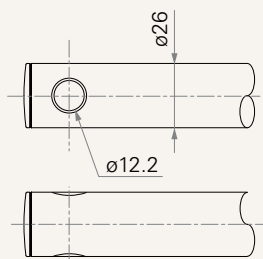

7 = Aluminum casting, U clevis, slot 6.2, depth 17.0, hole 10.2

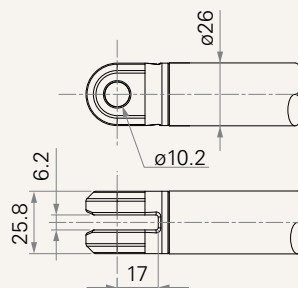

8 = Aluminum casting, U clevis, slot 6.2, depth 17.0, hole 12.2

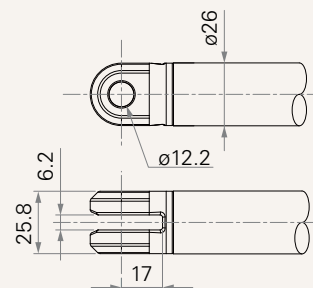

9 = Aluminum casting, U clevis, slot 6.2, depth 17.0, hole 10.2, with plastic T-bushing

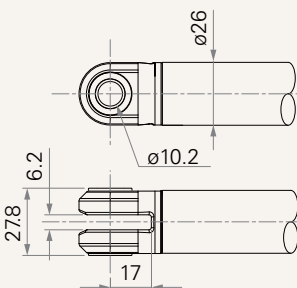

J = Aluminum casting, without slot, hole 10.2, for dental chair

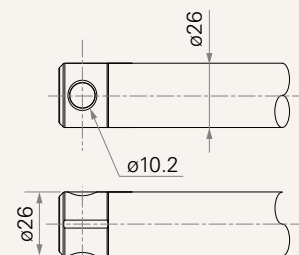

F = Aluminum casting, U clevis, slot 8.2, depth 19.0, hole 10.2, with T-bushing, manual release

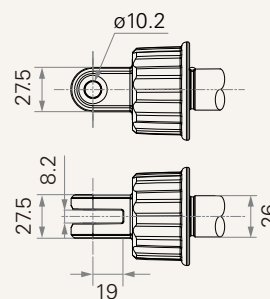

Direction of Rear Attachment (Counterclockwise)

1 = 0°

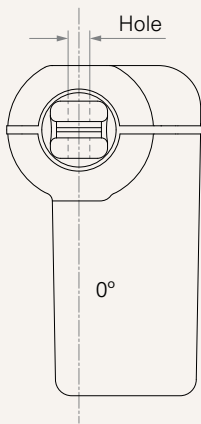

3 = 90°

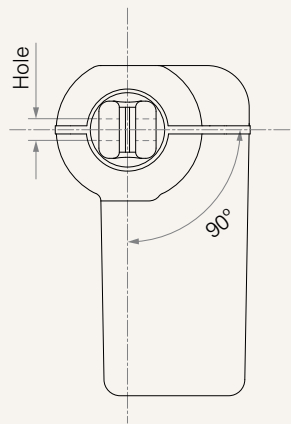

Functions for Limit Switches

Wire Definitions

CODE	Pin					
	● 1 (Green)	● 2 (Red)	○ 3 (White)	● 4 (Black)	● 5 (Yellow)	● 6 (Blue)
1	extend (VDC+)	N/A	N/A	N/A	retract (VDC+)	N/A
2	extend (VDC+)	N/A	middle switch pin B	middle switch pin A	retract (VDC+)	N/A
3	extend (VDC+)	common	upper limit switch	N/A	retract (VDC+)	lower limit switch
4	extend (VDC+)	common	upper limit switch	medium limit switch	retract (VDC+)	lower limit switch
5	extend (VDC+)	N/A	upper limit switch	common	retract (VDC+)	lower limit switch

Connector

1 = DIN 6P, 90° plug

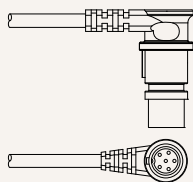

2 = Tinned leads



4 = Big 01P, plug

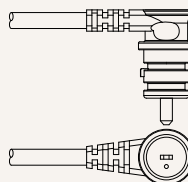

C = Y cable (for direct cut system, water proof, anti pull)

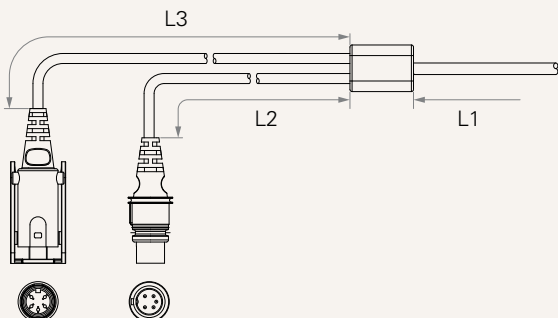

Cable length for direct cut system (mm)

CODE	L1	L2	L3
B	100	100	100
C	100	1000	400
D	100	2700	500
E	1000	100	100
F	100	600	1000
G	1500	1000	1000
H	100	100	1200

D = Extension cable, not preset on motor cover (cable length 120mm)

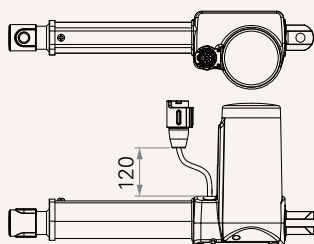

R = Extension cable, preset on motor cover (cable length 50mm)

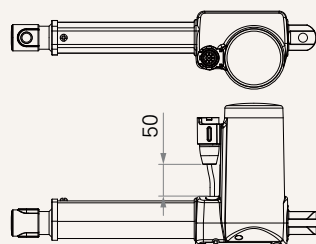

E = Molex 8P, plug

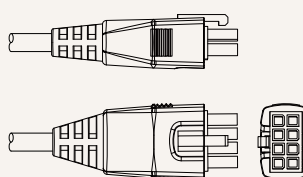

F = DIN 6P, 180° plug



G = Audio plug



M = DIN 4P, dental chair plug (40510-143, standard)



N = DIN 4P, dental chair plug (40510-040)



P = Molex 8P, 90° plug, without anti-clip

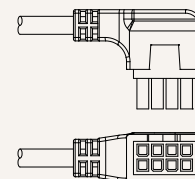

Q = Molex 6P, 90° plug, without anti-clip

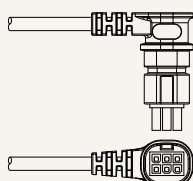

Terms of Use

The user is responsible for determining the suitability of TiMOTION products for a specific application. TiMOTION products are subject to change without prior notice.