

# TA31

series

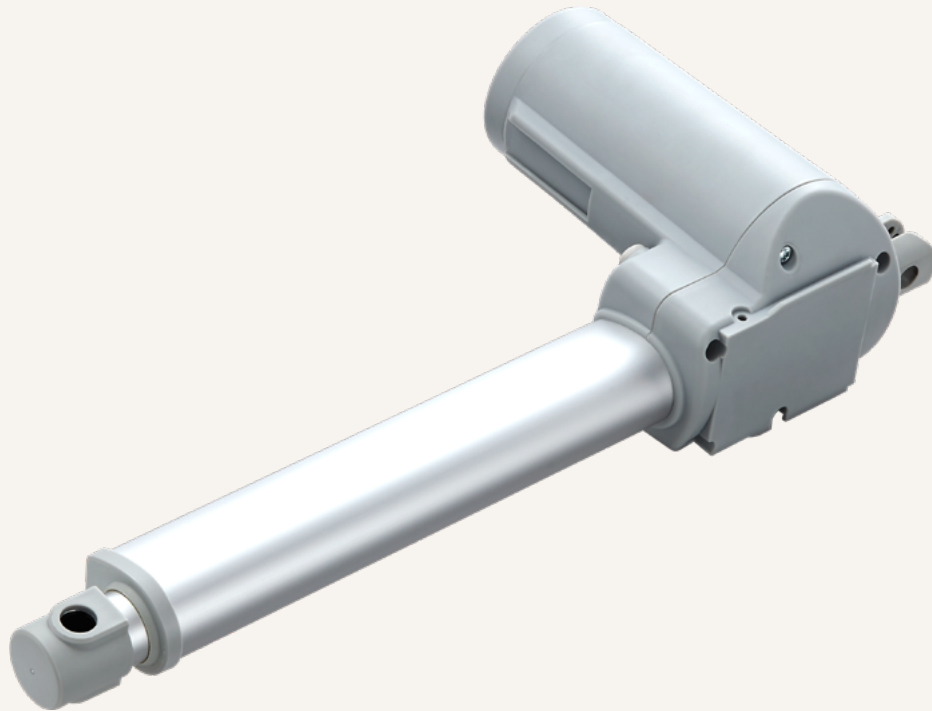

## Product Segments

### • Care Motion

The TA31 is one of our great medical grade linear actuators. It can lift up to 8000N and its IP rating is up to IP66W. The TA31 is a high quality solution for medical applications such as medical beds, medical chairs, or home care options.

#### General Features

Max. load	8,000N (push); 3,000N (pull)
Max. speed at max. load	3.7mm/s
Max. speed at no load	26.6mm/s
Retracted length	≥ Stroke + 157mm
IP rating	IP66W
Certificate	IEC60601-1, ES60601-1, IEC60601-1-2
Stroke	25~450mm
Output signals	Hall sensors
Options	Safety nut
Voltage	24V DC; 24V DC (PTC); 24V DC (3-brush motor)
Color	Black, grey
Operational temperature range at full performance	+5°C~+45°C

An economic solution with compact installation dimension

**Drawing**

Standard Dimensions  
(mm)

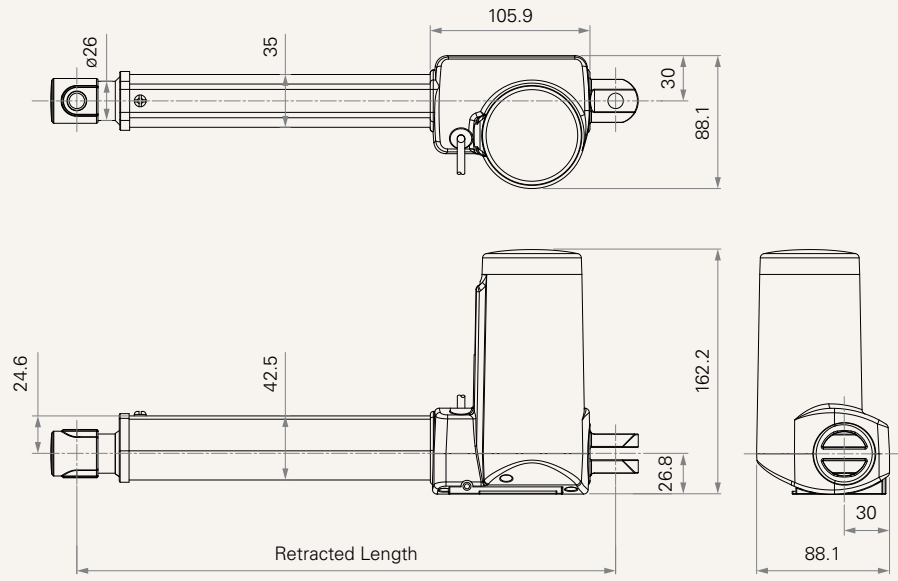

## Load and Speed

CODE	Load (N)		Self Locking Force (N)	Typical Current (A)		Typical Speed (mm/s)	
	Push	Pull		No Load 32V DC	With Load 24V DC	No Load 32V DC	With Load 24V DC

### Motor Speed (3800RPM, duty cycle 10%)

<b>B</b>	6000	3000	6000	0.8	3.6	6.0	3.3
<b>C</b>	5000	3000	5000	0.8	3.6	7.8	4.5
<b>D</b>	3500	3000	3500	0.8	3.8	11.7	6.6
<b>E</b>	2000	2000	2000	0.8	3.2	23.4	13.3
<b>F</b>	8000	3000	8000	0.8	4.7	6.0	3.0
<b>G</b>	6000	3000	6000	0.8	4.1	6.9	3.6

### Motor Speed (4500RPM, duty cycle 10%)

<b>H</b>	5000	3000	5000	1.0	3.7	7.7	4.7
<b>J</b>	3500	3000	3500	1.0	4.4	13.4	7.6
<b>K</b>	2000	2000	2000	1.0	3.8	26.6	16.2
<b>L</b>	8000	3000	8000	1.0	5.4	6.6	3.7
<b>M</b>	6000	3000	6000	1.0	4.5	7.6	4.6

## Note

- 1 Please refer to the approved drawing for the final authentic value.
- 2 This self-locking force level is reached only when a short circuit is applied on the terminals of the motor. All the TiMOTION control boxes have this feature built-in.
- 3 The current & speed in table are tested with 24V DC motor. With a 12V DC motor, the current is approximately twice the current measured in 24V DC; speed will be similar for both voltages.
- 4 The current & speed in table are tested when the actuator is extending under push load.
- 5 The current & speed in table and diagram are tested with TiMOTION control boxes, and there will be around 10% tolerance depending on different models of the control box. (Under no load condition, the voltage is around 32V DC. At rated load, the voltage output will be around 24V DC)
- 6 Standard stroke: Min.  $\geq 25\text{mm}$ , Max. please refer to below table.

CODE	Load (N)	Max Stroke (mm)
<b>C, D, E</b>	< 6000	450
<b>H, J, K</b>	< 6000	450
<b>B, G, M</b>	= 6000	450
<b>L, F</b>	= 8000	450

**Performance Data (24V DC Motor)**

Motor Speed (3800RPM, Duty Cycle 10%)

Speed vs. Load

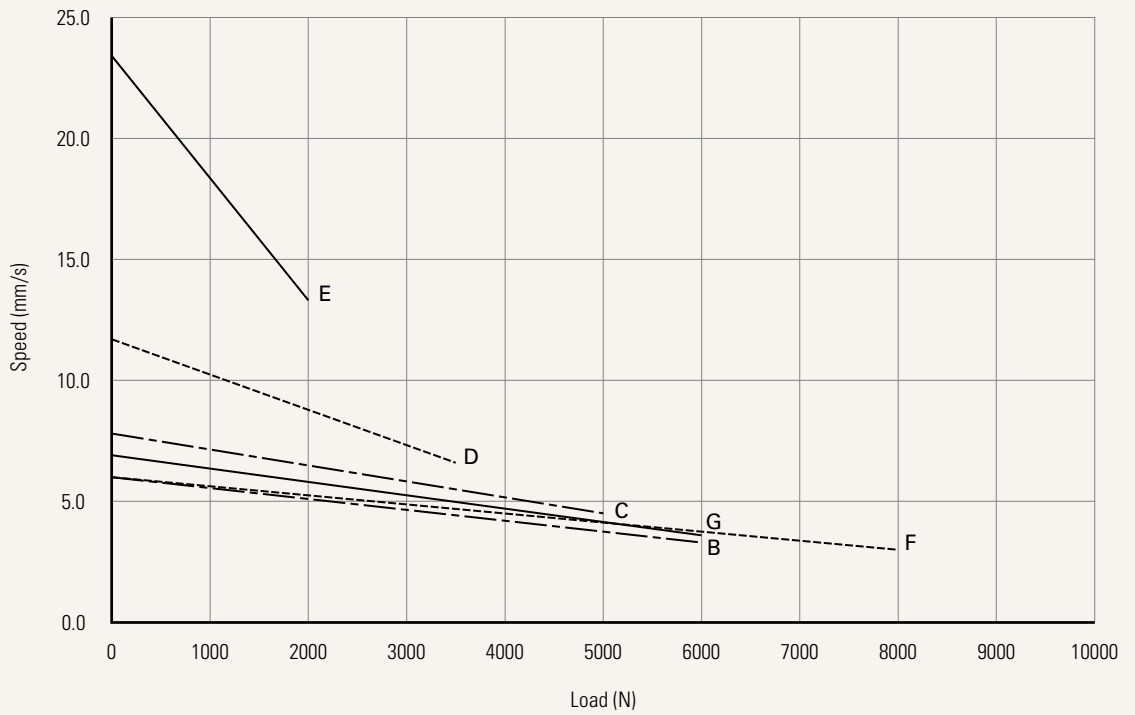

Current vs. Load

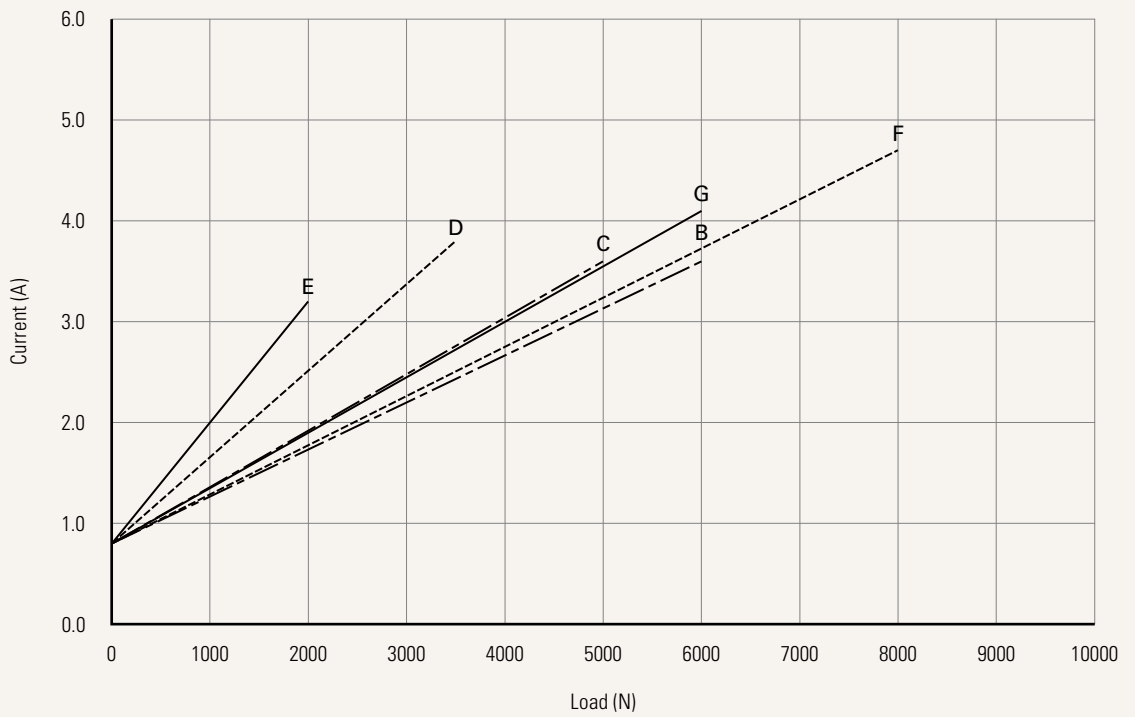

**Performance Data (24V DC Motor)**

Motor Speed (4500RPM, Duty cycle 10%)

Speed vs. Load

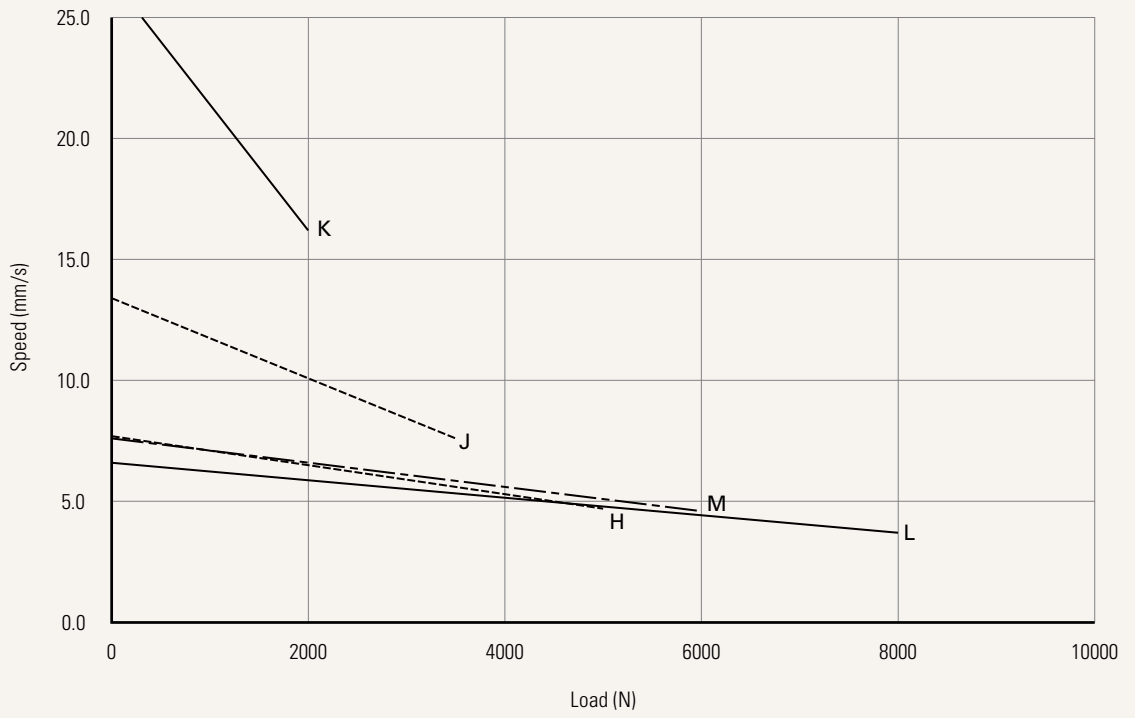

Current vs. Load

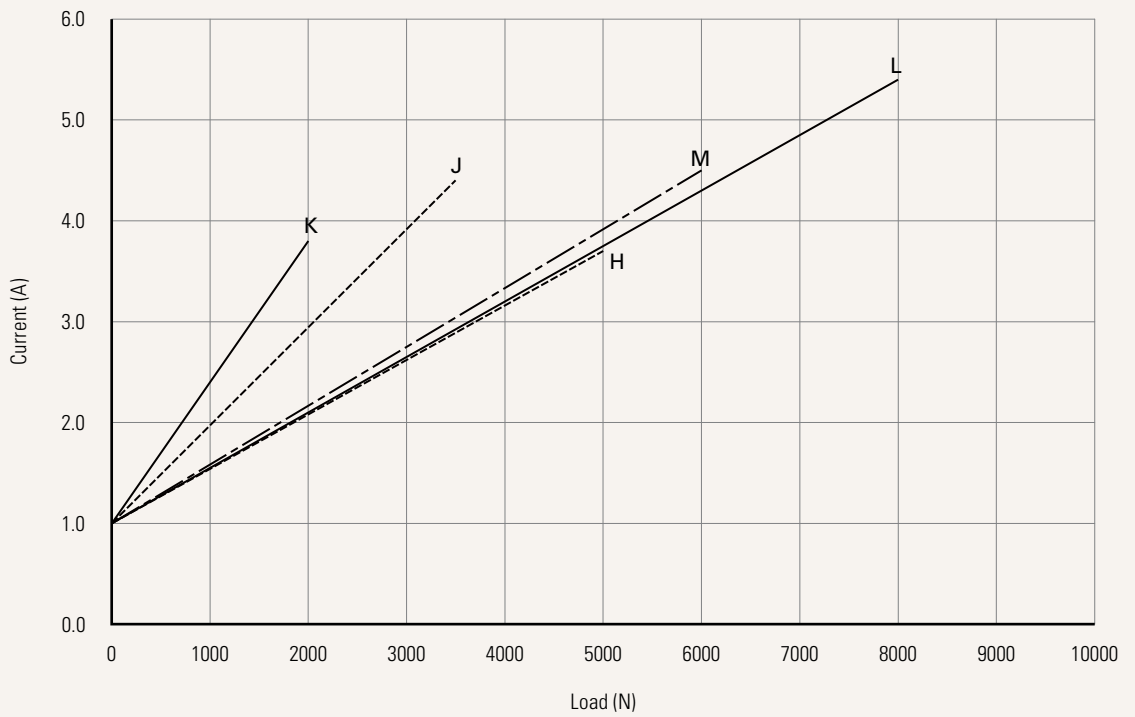

<b>Voltage</b>	2 = 24V DC	5 = 24V DC, PTC	C = 24V DC, 3-brush motor	
<b>Load and Speed</b>	<a href="#">See page 3</a>			
<b>Stroke (mm)</b>	<a href="#">See page 3</a>			
<b>Retracted Length (mm)</b>	<a href="#">See page 8</a>			
<b>Rear Attachment (mm)</b> <a href="#">See page 9</a>	2 = Plastic, U clevis, width 8.2, depth 17.0, hole 10.2 (for push < 4000N) 3 = Plastic, U clevis, width 8.2, depth 17.0, hole 12.2 (for push < 4000N) 4 = Aluminum casting, U clevis, width 8.2, depth 17.0, hole 10.2 (for push ≥ 4000N) 5 = Aluminum casting, U clevis, width 8.2, depth 17.0, hole 12.2 (for push ≥ 4000N)			
<b>Front Attachment (mm)</b> <a href="#">See page 9</a>	1 = Punched hole on inner Aluminum tube + plastic cap, without slot, hole 10.2, plastic bush 2 = Punched hole on inner Aluminum tube + plastic cap, without slot, hole 12.2 3 = Plastic, U clevis, width 8.2, depth 20.0, hole 10.2 (for push < 4000N, pull < 2500N) 4 = Plastic, U clevis, width 8.2, depth 20.0, hole 12.2 (for push < 4000N, pull < 2500N) 5 = Punched hole on inner Aluminum tube, without slot, hole 10.2, plastic bush		6 = Punched hole on inner Aluminum tube, without slot, hole 12.2 7 = Aluminum casting, U clevis, width 6.2, depth 17.0, hole 10.2 8 = Aluminum casting, U clevis, width 6.2, depth 17.0, hole 12.2 9 = Aluminum casting, U clevis, width 6.2, depth 17.0, hole 10.2, T bush	
<b>Direction of Rear Attachment (Counterclockwise)</b> <a href="#">See page 10</a>	1 = 0°	3 = 90°		
<b>Color</b>	1 = Black	2 = Pantone 428C		
<b>IP Rating</b>	1 = Without	2 = IP54	3 = IP66	5 = IP66W
<b>Special Functions for Spindle Sub-Assembly</b>	0 = Without (Standard) 1 = Safety nut		2 = Standard push only 3 = Standard push only + safety nut	
<b>Functions for Limit Switches</b> <a href="#">See page 10</a>	1 = Two switches at full retracted / extended positions to cut current 2 = Two switches at full retracted / extended positions to cut current + third one in between to send signal 3 = Two switches at full retracted / extended positions to send signal 4 = Two switches at full retracted / extended positions to send signal + third one in between to send signal 5 = Two switches at full retracted / extended positions to send signal (Operate with control box: TC8, TC10, TC14; compatible with hall sensors)			
<b>Output Signal</b>	0 = Without	2 = Hall sensors * 2		
<b>Connector (mm)</b> <a href="#">See page 11</a>	1 = DIN 6P, 90° plug 2 = Tinned leads 4 = Big 01P, plug C = Y cable (direct cut, water proof, anti-pull) J = Extension cable, not preset on motor cover (cable length 120) R = Extension cable, preset on motor cover (cable length 50)		E = Molex 8P, plug F = DIN 6P, 180° plug G = Audio plug P = Molex 8P, 90° plug, without anti-clip Q = Molex 6P, 90° plug, without anti-clip	
<b>Cable Length (mm)</b>	0 = Straight, 100 1 = Straight, 500 2 = Straight, 750 3 = Straight, 1000 4 = Straight, 1250	5 = Straight, 1500 6 = Straight, 2000 7 = Curly, 200 8 = Curly, 400	B-H = For direct cut system, <a href="#">See page 11</a> J = Extension cable, not preset on motor cover (cable length 120), <a href="#">See page 11</a> R = Extension cable, preset on motor cover (cable length 50), <a href="#">See page 11</a>	

<b>Voltage</b>	2 = 24V DC	5 = 24V DC, PTC		
<b>Load and Speed</b>	L = 8000N	M = 6000N		
<b>Stroke (mm)</b>	<a href="#">See page 3</a>			
<b>Retracted Length (mm)</b>	<a href="#">See page 8</a>			
<b>Rear Attachment (mm)</b>	C = Aluminum casting, U clevis, slot 8.2, depth 17.0, hole 10.2, with T-bushing <a href="#">See page 9</a>			
<b>Front Attachment (mm)</b>	F = Aluminum casting, U clevis, slot 8.2, depth 19.0, hole 10.2, with T-bushing, manual release <a href="#">See page 9</a>			
<b>Direction of Rear Attachment (Counterclockwise)</b>	1 = 0° <a href="#">See page 10</a>			
<b>Color</b>	1 = Black	2 = Pantone 428C		
<b>IP Rating</b>	1 = Without	2 = IP54	3 = IP66	5 = IP66W
<b>Special Functions for Spindle Sub-Assembly</b>	6 = Mechanical push only + safety nut			
<b>Functions for Limit Switches</b>	1 = Two switches at full retracted / extended positions to cut current <a href="#">See page 10</a>			
<b>Output Signals</b>	0 = Without			
<b>Connector</b>	1 = DIN 6P, 90° plug		G = Audio plug	
	<a href="#">See page 11</a> F = DIN 6P, 180° plug, for TEC extension cable standard option			
<b>Cable Length (mm)</b>	1 = Straight, 500	3 = Straight, 1000		

## Retracted Length (mm)

1. Calculate  $A+B+C = Y$
2. Retracted length needs to  $\geq$  Stroke + Y

A. Front Attach. Rear Attach.	
	General
	2, 3, 4
<b>1, 2, 5, 6</b>	+157
<b>3, 4</b>	+182
<b>7, 8, 9</b>	+172
<b>B, C</b>	+180
<b>F</b>	-

B.			
Stroke (mm)	Load (N)		
	< 6000	= 6000	= 8000
<b>25~150</b>	-	-	-
<b>151~200</b>	-	-	+5
<b>201~250</b>	-	+5	+10
<b>251~300</b>	-	+10	+15
<b>301~350</b>	+5	+15	+20
<b>351~400</b>	+10	+20	+25
<b>401~450</b>	+15	+25	+30

\* For stroke over 450mm, please contact our engineers.

C. Load < 5000 (N)		
Front Attach.	Spindle Function	
	0, 1	2, 3
<b>1, 2, 5, 6</b>	-	+5
<b>3, 4</b>	-	+5
<b>7, 8, 9</b>	-	+5
<b>F (Patient Hoist)</b>	-	-

C. Load = 5000 / 6000 / 8000 (N)		
Front Attach.	Spindle Function	
	0, 1	2, 3
<b>1, 2, 5, 6</b>	-	+8
<b>3, 4</b>	-	-
<b>7, 8, 9</b>	-	+8
<b>F (Patient Hoist)</b>	-	-



## Rear Attachment (mm)

2 = Plastic, U clevis, width 8.2, depth 17.0, hole 10.2 (for push < 4000N)

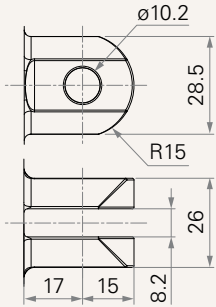

3 = Plastic, U clevis, width 8.2, depth 17.0, hole 12.2 (for push < 4000N)

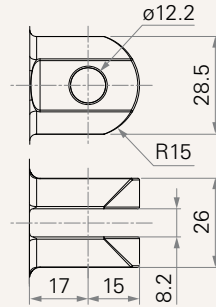

4 = Aluminum casting, U clevis, width 8.2, depth 17.0, hole 10.2 (for push ≥ 4000N)

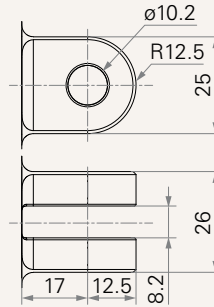

5 = Aluminum casting, U clevis, width 8.2, depth 17.0, hole 12.2 (for push ≥ 4000N)

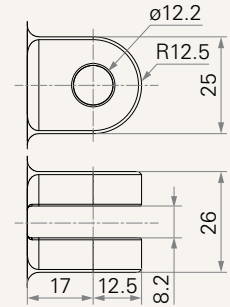

C = Aluminum casting, U clevis, slot 8.2, depth 17.0, hole 10.2, with T-bushing

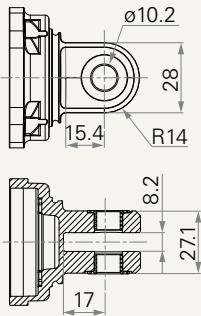

## Front Attachment (mm)

1 = Punched hole on inner Aluminum tube + plastic cap, without slot, hole 10.2, plastic bush

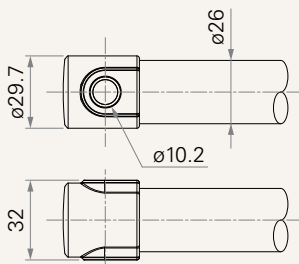

2 = Punched hole on inner Aluminum tube + plastic cap, without slot, hole 12.2

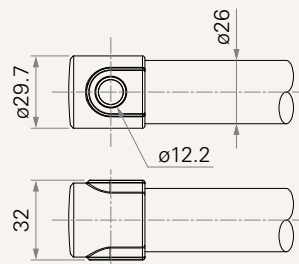

3 = Plastic, U clevis, width 8.2, depth 20.0, hole 10.2 (for push < 4000N, pull < 2500N)

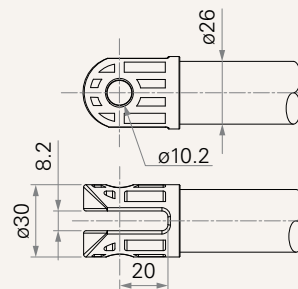

4 = Plastic, U clevis, width 8.2, depth 20.0, hole 12.2 (for push < 4000N, pull < 2500N)

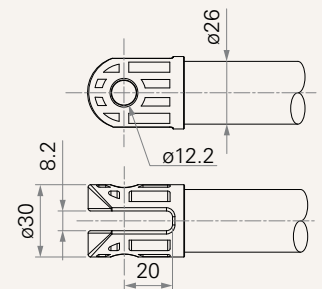

5 = Punched hole on inner Aluminum tube, without slot, hole 10.2, plastic bush

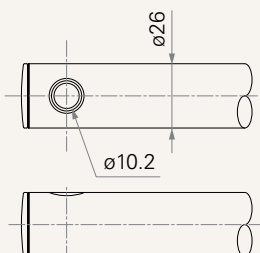

6 = Punched hole on inner Aluminum tube, without slot, hole 12.2

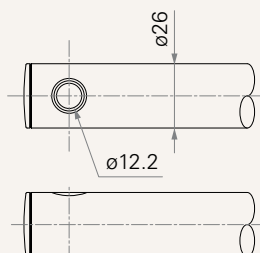

7 = Aluminum casting, U clevis, width 6.2, depth 17.0, hole 10.2

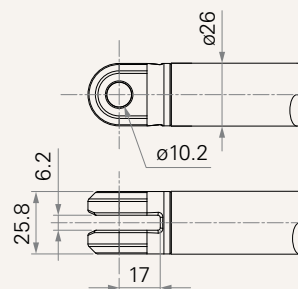

8 = Aluminum casting, U clevis, width 6.2, depth 17.0, hole 12.2

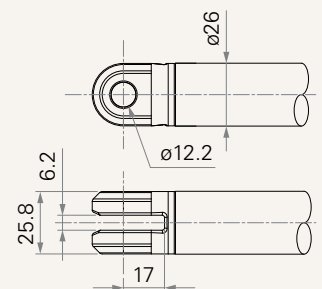

## Front attachment (mm)

9 = Aluminum casting, U clevis, width 6.2, depth 17.0, hole 10.2, T bush

F = Aluminum casting, U clevis, slot 8.2, depth 19.0, hole 10.2, with T-bushing, manual release

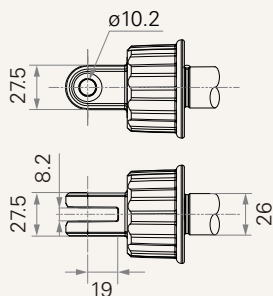
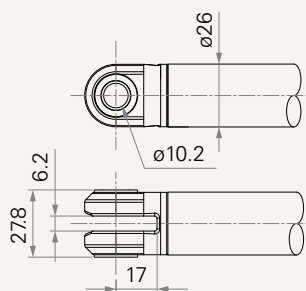

## Direction of Rear Attachment (Counterclockwise)

1 = 0°

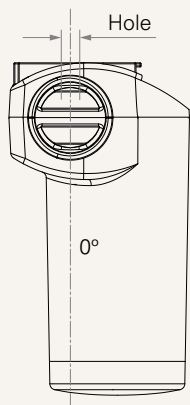

3 = 90°

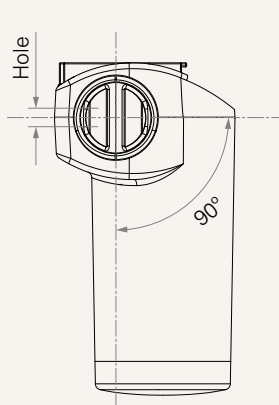

## Functions for Limit Switches

### Wire Definitions

CODE	Pin					
	● 1 (Green)	● 2 (Red)	○ 3 (White)	● 4 (Black)	● 5 (Yellow)	● 6 (Blue)
1	extend (VDC+)	N/A	N/A	N/A	retract (VDC+)	N/A
2	extend (VDC+)	N/A	middle switch pin B	middle switch pin A	retract (VDC+)	N/A
3	extend (VDC+)	common	upper limit switch	N/A	retract (VDC+)	lower limit switch
4	extend (VDC+)	common	upper limit switch	medium limit switch	retract (VDC+)	lower limit switch
5	extend (VDC+)	N/A	upper limit switch	common	retract (VDC+)	lower limit switch

## Connector (mm)

1 = DIN 6P, 90° plug

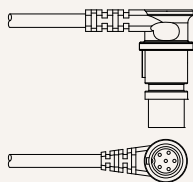

2 = Tinned leads



4 = Big 01P, plug

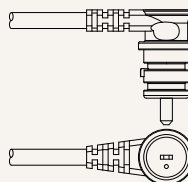

C = Y cable (direct cut, water proof, anti-pull)

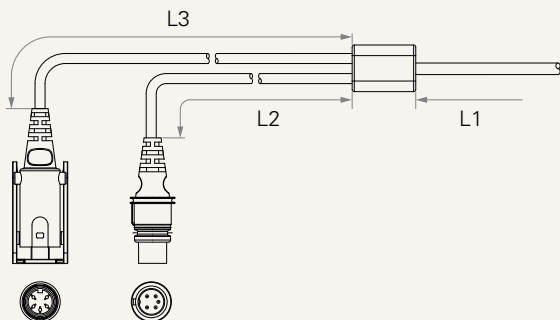

### Cable length for direct cut system (mm)

CODE	L1	L2	L3
B	100	100	100
C	100	1000	400
D	100	2700	500
E	1000	100	100
F	100	600	1000
G	1500	1000	1000
H	100	100	1200

J = Extension cable, not preset on motor cover (cable length 120)

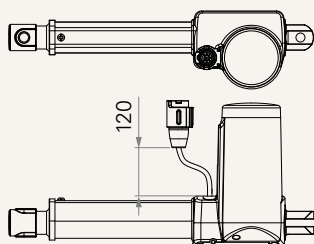

R = Extension cable, preset on motor cover (cable length 50)

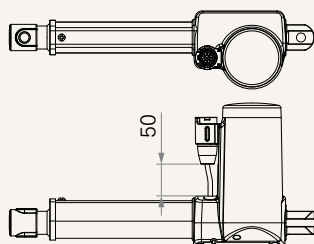

E = Molex 8P, plug

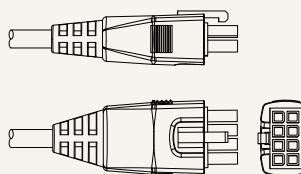

F = DIN 6P, 180° plug



G = Audio plug



P = Molex 8P, 90° plug, without anti-clip

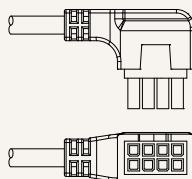

Q = Molex 6P, 90° plug, without anti-clip

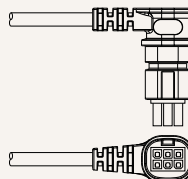

## Terms of Use

The user is responsible for determining the suitability of TiMOTION products for a specific application. TiMOTION products are subject to change without prior notice.