

TP7M

series



Product Segments

- **Care Motion**

General Features

Transformer type	SMPS
Input voltage	100~240V AC
Max. output	29V DC, 3.75A
Plug support	EU, USA, AUS, UK, JPN
Color	Black or grey
Options	Anti Pulling Clip
Certificate	UL, ACMA, PSE, IEC/EN 60335-2-29, IEC 60601-1, IEC 60601-1-2
Wall mount design	

Drawing

Standard Dimensions
(mm)

Dimensions with EU Plug
(mm)

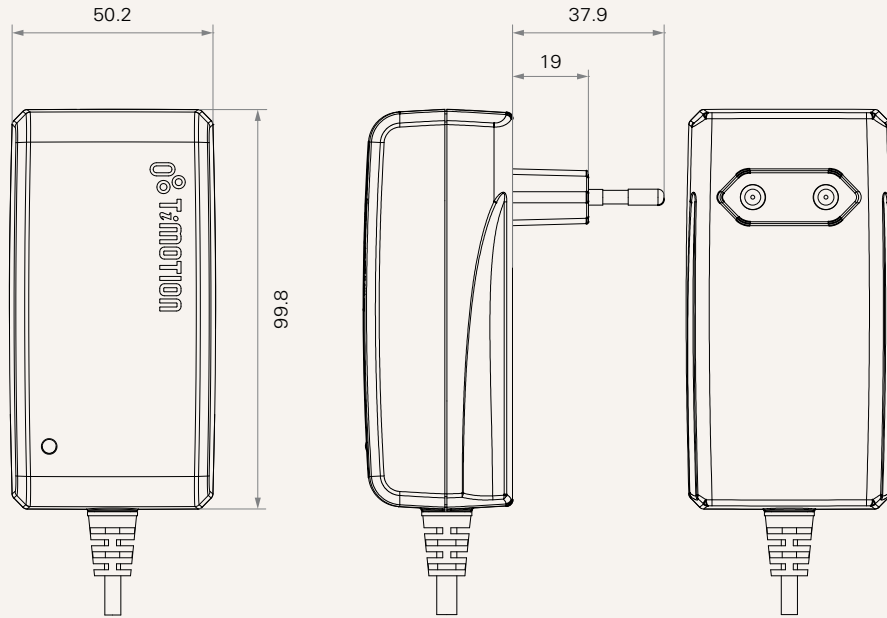

Dimensions with USA Plug
(mm)

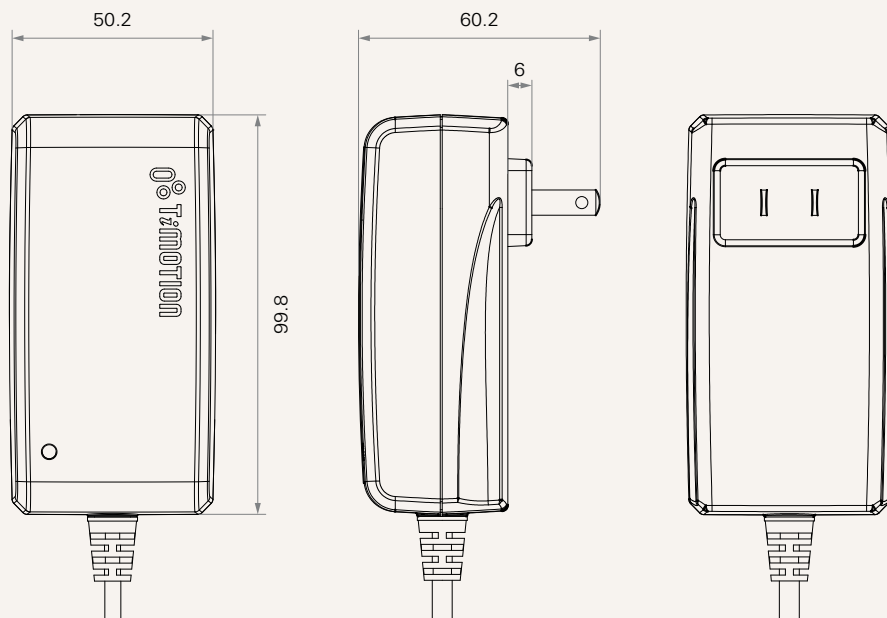

Drawing

Standard Dimensions
(mm)

Dimensions with AUS Plug
(mm)

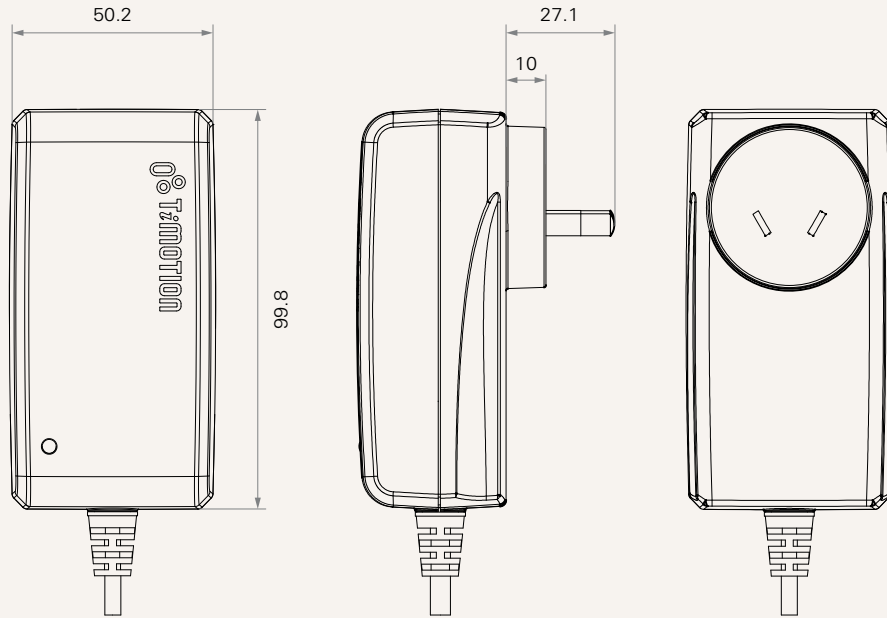

Dimensions with UK Plug
(mm)

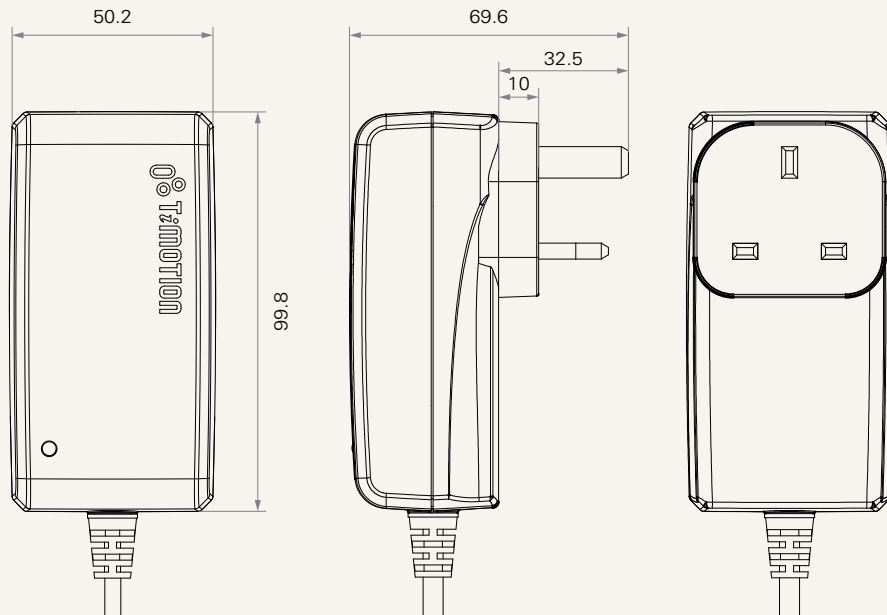

Drawing

Standard Dimensions
(mm)

Dimensions with JPN Plug
(mm)

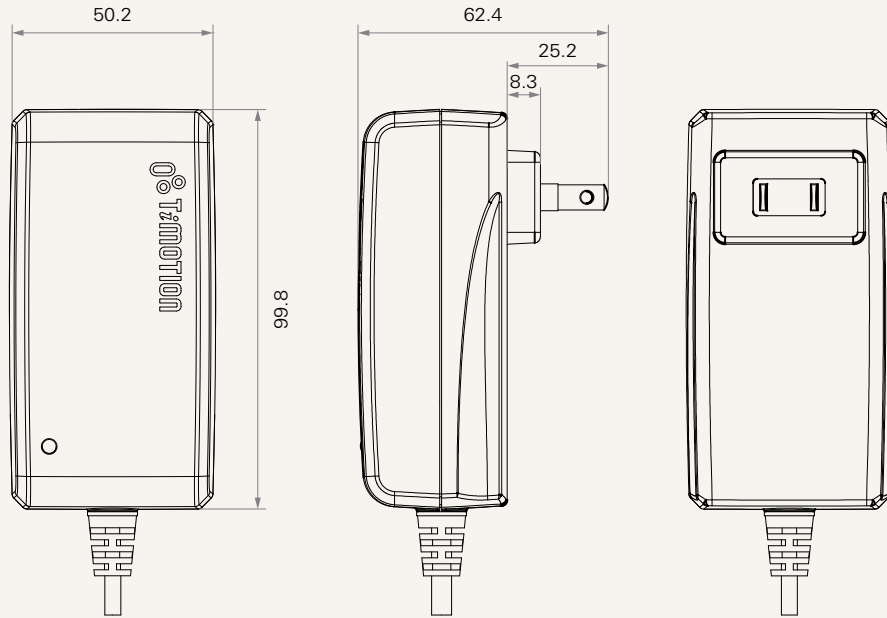

TP7M

Version: 20200603-D

Input Voltage	4 = 100~240VAC (SMPS)		
AC Plug	1 = EU 2 = USA	3 = AUS 4 = UK	5 = JPN
Anti Pulling Clip	1 = With		
DC Output Socket	3 = Long DIN 5P	8 = Small 01P	
DC Cable Length (mm)	2 = Straight, 2000	4 = Straight, 4000	
Color	1 = Black	2 = Pantone 428C	
IP Rating	1 = Without		

Terms of Use

The user is responsible for determining the suitability of TiMOTION products for a specific application. TiMOTION products are subject to change without prior notice.